

---

## **Part 3      Proceedings of the Roadmap Working Group**

---

The Roadmap development process included four intensive workshops held from October 2005 through December 2006. Following an inaugural workshop San Francisco, the meetings were sponsored by the Battelle Memorial Foundation and hosted by the Oak Ridge, Brookhaven, and Pacific Northwest National Laboratories.

The Working Group Proceedings presents a collection of papers, extended abstracts, and personal perspectives contributed by participants in the Roadmap workshops and subsequent online exchanges. These contributions are included with the Roadmap document to make available, to the extent possible, the full range of ideas and information brought to the Roadmap process by its participants.

The papers are arranged in the order given below.

### **Atomically Precise Fabrication**

- 01 Atomically Precise Manufacturing Processes
- 02 Mechanosynthesis
- 03 Patterned ALE Path Phases
- 04 Numerically Controlled Molecular Epitaxy
- 05 Scanning Probe Diamondoid Mechanosynthesis
- 06 Limitations of Bottom-Up Assembly
- 07 Nucleic Acid Engineering
- 08 DNA as an Aid to Self-Assembly
- 09 Self-Assembly
- 10 Protein Bioengineering Overview
- 11 Synthetic Chemistry
- 12 A Path to a Second Generation Nanotechnology
- 13 Atomically Precise Ceramic Structures
- 14 Enabling Nanoscience for Atomically-Precise Manufacturing of Functional Nanomaterials

### **Nanoscale Structures and Fabrication**

- 15 Lithography and Applications of New Nanotechnology
- 16 Scaling Up to Large Production of Nanostructured Materials

- 
- 17 Carbon Nanotubes
  - 18 Single-Walled Carbon Nanotubes
  - 19 Oligomer with Cavity for Carbon Nanotube Separation
  - 20 Nanoparticle Synthesis
  - 21 Metal Oxide Nanoparticles

### **Motors and Movers**

- 22 Biological Molecular Motors for Nanodevices
- 23 Molecular Motors, Actuators, and Mechanical Devices
- 24 Chemotactic Machines

### **Design, Modeling, and Characterization**

- 25 Atomistic Modeling of Nanoscale Systems
- 26 Productive Nanosystems: Multi-Scale Modeling and Simulation
- 27 Thoughts on Prospects for New Characterization Tools
- 28 Characterization/Instrumentation Capabilities for Nanostructured Materials

### **Applications**

- 29 Nanomedicine Roadmap: New Technology and Clinical Applications
- 30 Applications for Positionally Controlled Atomically Precise Manufacturing Capability
- 31 Piezoelectrics and Piezo Applications
- 32 Fuel Cell Electrocatalysis: Challenges and Opportunities
- 33 Atomic Precision Materials Development in PEM Fuel Cells
- 34 Hydrogen Storage
- 35 The Potential of Atomically Precise Manufacturing in Solid State Lighting
- 36 Towards Gaining Control of Nanoscale Components and Organization of Organic Photovoltaic Cells
- 37 Impact of Atomically Precise Manufacturing on Transparent Electrodes
- 38 Atomically Precise Fabrication for Photonics: Waveguides, Microcavities
- 39 Impact of Atomically Precise Manufacturing on Waveguide Applications

# Atomically Precise Manufacturing Processes

## Introduction

In this section, atomically precise manufacturing (APM) will be discussed. As discussed elsewhere, productive nanosystems do not necessarily carry out APM, though that is expected to be one of their most important uses, and that it is possible to do APM with methods that do not employ productive nanosystems. The heart of this section is the discussion of the process of APM whether carried out by productive nanosystems or macroscale machinery and instrumentation.

An atomically precise manufacturing (APM) process will be able to create products where the type, number, and position of all atoms and/or molecules in the product are known. The yield of any manufacturing process is rarely 100%, and we should not expect that APM processes will be free of defects.

By this definition, there are many chemical manufacturing processes that would qualify as APM, in particular as bottom-up, self-assembly. However, these chemical manufacturing processes have limitations that we expect can be overcome by more advanced APM processes. One of the prime distinctions that one could use to distance more advanced APM processes from the chemical manufacturing processes today, is that self-assembly tends to produce structures in their minimum energy configuration. Indeed, it is the minimization of energy that drives most chemical reactions.

The fact that the output of any self-assembly process would have to minimize energy in the output product presents some limitations. A microprocessor, the heart of most electronic computers, is not a minimum energy arrangement of the semiconductor, metal, and insulating materials that make up the integrated circuit chip. However, the fact that a single self assembly step drives to minimum energy configuration, does not restrict the output of multiple self assembly processes from producing products that are not in their minimum energy configuration. Given a sufficiently clever chemical synthesis approach, very complex molecules can be created that are certainly not a minimum energy configuration of their constituent atoms. Complex molecules can self assemble into more complex structures that can be useful. One could argue that the most complex structures on the planet, multi cell living organisms are created by self-assembly. In this section however, the possibility of a top-down, mechanically implemented, computer controlled process will be explored.

## Simplifying Assumptions

The following assumptions are made:

1. To do APM, it is required to deliver specific atoms and/or molecules to a particular point in space and to get them to bind to the product in the desired fashion. The designer of the product will predetermine the position of each atom or molecule, its binding method, and to some extent the order of the assembly of the atoms and molecules.
2. The value of an APM process will increase with the size and complexity of the product and the range of materials that may be designed in.

## Assembly

In order to assemble atoms or molecules there must be available binding sites, with some sort of binding interaction that could be covalent, metallic, ionic, or hydrogen bonds, or some form of Van der Waals interaction. And there must be some method of delivering the correct atom or molecule to the desired location in a way that will lead to the desired interaction that results in the atom or molecule binding to and becoming part of the desired structure.

In addition, it is necessary to protect the binding site from having an undesirable interaction with some atom or molecule other than the one that is intended to bind there. This is usually accomplished by excluding any undesirable atoms or molecules from the environment by using highly purified feedstock and either highly purified solvents or ultra high vacuum environments.

Another component of APM can be protecting the binding sites until it is desirable to react/assemble/bind the appropriate atom or molecule. This protection is done by a surrogate atom or molecule that keeps the binding site unreactive until some process removes the surrogate, "deprotecting" the site.

## Limitations of Bottom-Up Assembly

Much of the beauty and complexity in chemical synthesis is the combinations of chemical reactions that add molecules and later remove part (or all) of what was added as the complex molecule is built up.

When diffusion is the method of delivering the atom or molecule, there are two problems and one large advantage. The advantage is that diffusion is a massively parallel process with little or no cost. The disadvantages are the stochastic nature of the process and the lack of spatial control. The stochastic nature of the self-assembly leads to yields of less than 100% on any one step. When the synthesis involves many steps the problem is compounded. For example the ability to synthesize designed sequences of DNA is of huge value, but these synthesized DNA strands are limited to a modest number of base pairs, because of this very problem.

The lack of spatial control creates problems when multiple identical binding sites exist that need different components added to them. It is difficult if not impossible to address these identical binding sites when using diffusion as the delivery mechanisms.

While there are techniques to deal with these limitations, they do result in trade off between the complexity of the end product and the robustness of the self assembly process. Using crystal growth as one model of self-assembly, we can see this trade-off. Simple crystals such as Si can be grown with a straight forward and robust process that produces large, high purity, nearly perfect crystals. Complex crystals such as protein crystals are notoriously difficult to grow. Recently some extremely impressive self assembly has been demonstrated by using relatively complex molecules (DNA strands) that allow arbitrary two dimensional structures to be created in solution. Impressive as these results are, the writer of this section believes that the complexity – robustness trade-off is still at work.

While a bottom-up self-assembly path to APM is certainly worth pursuing because of its economy due to the massively parallel nature, the limitations listed above are reason enough to consider alternative pathways that may circumvent some of these limitations.

## Spatially Controlled Assembly

In 2007 there exists the ability to control motion in three dimensions with at least three degrees of freedom with sub-atomic resolution and excellent stability. In fact this technology has been in existence for more than 17 years as evidenced by Don Eigler's assembly of 35 Xenon atoms on a metal lattice to spell out IBM. This was an early example of spatially controlled assembly with top down control that put every atom in a designed and atomically precise position.

The idea of capturing atoms or molecules with some physical device and positioning them so that they bind to the desired location has been termed mechano synthesis. This has two distinct advantages over self assembly. The first of these is that it is not stochastic process. Mechano synthesis controls the delivery of the desired atom or molecule to its

designed binding site. This results in the ability to create directly structures that are not in their minimum energy configuration. This also leads directly to the second advantage of avoiding the need to protect and deprotect binding sites. When the atomic or molecular building blocks are delivered to the binding site by some mechanism that controls its path then other potential binding sites do not need to be protected. The ability to avoid the need to protect and deprotect binding sites is an attractive feature.

The requirement of having to directly manipulate each atom or molecule would seem to be a huge disadvantage compared to self-assembly where the delivery of atoms or molecules in a massively parallel manner is easily accomplished. It is an important point that, productive nanosystems could also provide the massive parallelism required to produce atomically precise products cost effectively. In this section however, we will not explore the requirements for achieving the productive nanosystems themselves but rather the mechanisms that could be used by any approach to APM. Thus we will consider the ability to do spatially controlled assembly of atoms and molecules with available technology.

## Molecular Manipulation Methods

In principle there are a wide range of mechanisms that could be used for spatially controlled assembly. Gas phase flow, fluid flow, optical trapping, and electromagnetic methods all have the ability to transport particles and deliver them to specific locations with some degree of accuracy. However, none of these methods have demonstrated the required positional control accuracy and for a number of reasons, do not seem likely to be able to do so. Further, spatially controlled assembly will sometimes be required to control the orientation of the atoms or molecules to be assembled. In addition, there may be a requirement to apply some force to overcome the repulsive or anti-bonding forces that must be overcome to achieve the desired bonding. The ability to apply local force to drive a particular binding interaction, is something not generally possible with self-assembly. These somewhat indirect methods of spatially controlling atoms or molecules may have a difficult time achieving the positional accuracy, orientation control, and force required for spatially controlled assembly. I leave it to others to explore these techniques. Instead we will concentrate on direct mechanical manipulation for spatially controlled assembly.

The required accuracy for spatially controlled assembly is, the first order the length of the chemical bonds that are formed in the assembly process. We will take this distance to be on the order of 1 Angstrom or 0.1nm. As mentioned above, the instrumentation to do spatial manipulation with this precision has been around for at least 18 years for three dimensional positioning with three degrees of freedom. A device to provide closed loop control with 0.1nm accuracy



and six degrees of freedom has not been developed to our knowledge, but the individual capabilities are available and the integration is certainly conceivable.

The problem at present is not the positional capabilities, but the atomically precise end effectors required to capture the atoms or molecules in the correct orientation and to be able to have them transfer reliably to the desired binding site. Some end effectors have been designed to transfer carbon dimers to a diamond lattice and to bind epitaxially. *Ab Initio* calculations have confirmed the stability of the tool and its ability to transfer the dimers to the diamond lattice. On the other hand this tool has not yet been fabricated and a method of recharging the tool has yet to be worked out. The opportunities to develop mechanosynthesis into an atomically precise manufacturing technology and subsequently into productive nanosystems will be explored in another section.

## Spatially Controlled Deprotection

Working from within existing technology, there is an opportunity to develop APM by using spatially controlled deprotection rather than mechanosynthesis. This has several disadvantages compared to mechanosynthesis. Obviously, it must use the protection and deprotection approach that is possible to avoid in direct mechanosynthesis. Also it loses the ability to use locally applied force to drive binding interactions. The major advantage at present is it does not require end effectors to directly manipulate the atomic or molecular building blocks.

There is a requirement for atomically precise deprotection. There are examples of atomically precise removal of atoms and molecules from surfaces using scanning probes that have been reported in the scientific literature. Some of these have achieved atomic precision. It is reasonable to expect that these capabilities will be expanded in terms of what atoms and molecules that can be removed, the surfaces and structures that these species can be removed from, and the number of these that achieve atomic precision. For scanning probe instruments, in the near term, these techniques are likely to be largely restricted to surfaces.

It would be desirable for the species that can be removed from a surface, also provide complete protection of all of the available binding sites on the surface. Combining the ability to remove specific atoms or molecules from surfaces with the ability to deliver and deposit a desired atom or molecule via diffusion in the now available binding site is a potential route to atomically precise manufacturing.

Patterned Si Atomic Layer Epitaxy (ALE), is an example of this approach. Atomic precision Si ALE is explored in some detail in another section and will only be described briefly here. Lyding and others have demonstrated the ability to remove H atoms that have been deposited on Si

surfaces by using an Ultra High Vacuum (UHV) scanning tunneling microscope (STM). Electrons tunneling from the STM tip excite the Si-H bond and can induce desorption of the H atom from the Si surface. The ability to target and remove a single H atom from the Si surface has been demonstrated. This basic capability is being developed into an atomically precise lithographic technique, that is the ability to produce atomically precise patterns of H on Si surfaces. Atomic Layer Epitaxy of Si is a cyclic Chemical Vapor Deposition (CVD) process that deposits a monolayer (or a well defined fraction of a monolayer) per ALE cycle. The deposition self limits due to the Si atoms that bind epitaxially to the surface, carry with them an atom or molecule that “protects” the newly deposited surface from further deposition. In another part of the ALE cycle the protecting or passivating species are globally removed from the surface effectively deprotecting the surface allowing a subsequent monolayer of atoms to be deposited in the next ALE cycle. In several cases, notably using disilane Si<sub>2</sub>H<sub>6</sub> as a precursor gas, the passivating species is H. The patterned Si ALE process then is accomplished by replacing the global removal of H with a patterned removal of H. ALE cycles then will only deposit Si in the areas that have deprotected by atomically precise H depassivation lithography. This provides atomic resolution in all three dimensions and is a path towards APM that is being pursued.

The patterned Si ALE approach described above, is just one manifestation of spatially controlled deprotection. Other embodiments could be developed by considering or developing other ALE processes that use a protecting species as the self limiting mechanism and find an approach to selectively remove those species with atomic precision. While there are applications for atomically precise Si structures on Si surfaces, APM will become much more useful as these other paths are successfully explored and exploited. In particular the ability to deposit with atomic precision in the same APM tool, metals, insulators, optically active materials and semiconductors will lead to many more applications.

## Gas Phase Patterned ALE

As the highest resolution imaging Scanning Probe instruments are typically UHV STMs, and many of the known ALE and its cousin Atomic Layer Deposition (ALD) are gas phase processes, it is natural to explore gas phase processes as candidates for APM.

## Review of Gas Phase ALE Processes

### *Early Gas Phase Atomic Layer Epitaxy*

Early work explored the deposition of compound semiconductors such as GaAs where self limiting growth of alternating Ga and As layers are performed with gaseous

precursors such as trimethylgallium and tetrabutylarsine. Although there has been some debate about the details of the self-limiting mechanisms that result in single monolayer inclusion over a wide range of conditions, there is ample experimental evidence of atomic layer control. Other compound semiconductors and oxides: ZnSe, ZnTe, ZnS, GaP, InP, InAs, AlGaAs, AlAs, GaInP, CdTe, SiC; tantalum oxide, Niobium oxide, indium oxide, indium-tin oxide, SnO<sub>2</sub> have been deposited with ALE. Numerous approaches to elemental semiconductors Si and Ge have been successfully demonstrated. The list for processes and materials that involve the deposition of amorphous materials through ALD is even more extensive.

In the vast majority of these gas phase ALE and ALD processes, the self-limiting mechanism is a passivating or protecting atom or molecule that is deposited along with the atom or molecule of choice. With the passivating species in place, the deposition of the desired material saturates and is limited to a monolayer or a well-defined fraction (or in a few cases multiplier) of a monolayer. This passivating species is then removed with a subsequent process allowing another layer of material to be deposited.

In some instances, such as many compound semiconductors, the de-passivation occurs naturally when a precursor for the alternate material is introduced and will react with the passivated surface removing the passivating species and achieving a self-limiting deposition of the alternate material. While this produces a relatively simple ALE process, that requires only the cyclic exposure of different precursors, often at constant temperature, such a process is not immediately adaptable to a patterned deprotection approach.

For other ALE processes the passivation layer must be removed with a process independent of deposition of material. Such is the case for elemental semiconductors Si and Ge for instance. Numerous ALE processes have been developed for Si and Ge with a wide variety of precursors (SiH<sub>4</sub>, Si<sub>2</sub>H<sub>4</sub>, SiCl<sub>2</sub>H<sub>2</sub>, GeH<sub>4</sub>, Ge<sub>2</sub>H<sub>6</sub>, GeH<sub>2</sub>(CH<sub>3</sub>)<sub>2</sub>, GeCl<sub>4</sub>). In each of these processes, a passivator self-limits the deposition and must be removed with some processes that is done when the environment does not include the precursor gas. The processes that remove the passivators include: thermal energy; electron, ion, or photon bombardment; and gas phase chemistry. Any of these processes that are used to globally remove the passivators could be replaced with a process that removes the passivators in a pattern.

### *Atomic Precision (or Near AP) Depassivation Schemes*

A scanning probe instrument could be used to create de-passivation patterns. The technique that has been used most extensively and with atomic precision, is the atomic

resolution de-passivation of H from Si surfaces. The Roadmap main text presents a path to APM and subsequently productive nanosystems starting with atomic precision Si ALE where the patterning is accomplished via H de-passivation of Si.

However, using electron transfer from (or to) an STM tip to excite and break the bond of an adsorbate on the surface of Si or other substrates is being extended to other molecules. Benzene, cyclopentene, and other molecules have been de-passivated from Si surfaces. There is an excellent possibility to develop atomic precision patterning of a variety of molecules on a variety of surfaces. A subset of these processes could be used to develop patterned ALE in other material systems.

Note that the self-limiting species that is used in the ALE process does not necessarily need to be the species that is patterned. It may be possible to replace the ALE self-limiting species with one that can be patterned and that is either used as a mask for deposition of the material being constructed, or if the patternable species is not adequately robust as a deposition mask, then the patterned species could mask the deposition of a species that is sufficiently robust to mask deposition.

### *Liquid Phase Patterned ALE*

While most ALE and ALD are based on gas phase chemistry, there are a number of known liquid phase ALE and ALD processes for a variety of material systems. A liquid phase approach brings the wealth of solution phase chemistry to bear. It also has the distinct advantage of avoiding the expense of UHV systems and the technical difficulties that are inherent to these systems.

Two of the more prominent liquid phase atomic layer deposition techniques are Electro Chemical Atomic Layer Epitaxy (ECALE) and Successive Ionic Layer Adsorption and Reaction (SILAR). A non-exhaustive list of materials deposited with liquid phase atomic layer techniques includes: ZnS, ZnTe, ZnSe, PbS, PbSe, CdS, CdTe, CdSe, HgSe, GaAs, Bi<sub>2</sub>Te<sub>3</sub>, Sb<sub>2</sub>Te<sub>3</sub> and Pt.

Liquid phase chemistry is very rich and should provide more opportunities than gas phase chemistry to develop atomic layer epitaxial techniques. At the moment however, there is no known patterning technique that achieves atomic resolution in a liquid medium.

### *Atomic Precision Patterning for Liquid Phase ALE*

Although not well developed, STM in liquids has been developed. The principle drawback is the need to maintain very high purity and low conductivity fluids to work within,

but this is not necessarily an insurmountable hurdle as APM will require very pure materials in any case.

AFM in liquids has been better developed than STM. The principle problem is the damping of the cantilever but atomic resolution imaging in liquids has been arguably demonstrated.

There is an Atomic Force Microscope patterning technique for self-assembled monolayers (mainly alkane thiols) sometimes referred to as nanografting that has achieved very high resolution patterning in solution by “scraping” away the alkane thiols from a gold surface. An analog of this could be used to depassivate a surface in a yet to be developed liquid phase ALE process. The major issue in this approach is tip structure and tip wear. In order to achieve atomic resolution, a tip will need to be very small and therefore vulnerable to wear.

SILAR and ECALE use electric fields in the control of the deposition process. The ability of an STM tip to inject and remove charge may provide an opportunity to pattern the deposition of a layer, however, keeping the charge localized may be an issue.



# Mechanosynthesis

## Introduction

Mechanosynthesis is the assembly of molecules, fabrication of new materials, or the chemical modification of structures or reaction pathways by way of mechanical processes or forces. The field of mechanosynthesis shares many parallels with synthetic chemistry, while differing fundamentally in the means by which control over a chemical reaction is maintained. Both the range of explored physical capabilities and the demonstration of mechanosynthetic utility in the laboratory are in their infancy, with the continued maturation of experimental technologies only recently enabling the mechanical manipulation of small molecules for the synthesis of new products or the removal and deposition of single atoms within atomic lattices by macroscale control. As an experimental science, demonstrated mechanosynthetic operations on single atoms or molecules have resulted from the push of macroscale technologies to their limits, continuing to drive further developments in the field of atomic microscopy. Biological systems have also employed mechanosynthetic operations in conjunction with cellular processes for the conversion of reactants into products, providing model systems of synergistic interplay that, like possible approaches in laboratory settings, employ methodologies of chemical control based on specific tasks in much larger systems of nanoscale assembly. The two classic biological systems to which mechanical motion and positioning in molecular assembly are associated are adenosine triphosphate (ATP) synthesis via the rotary-catalysis mechanism in ATP synthase [Ref. 1] and the positional activation of sequential peptide bond formation in amino acids in ribosomes in the mRNA translation process [Ref. 2]. As a very new addition to the spectrum of experimental techniques for nanoscale control, the broader impact of mechanosynthesis as a methodology in productive nanosystem implementation is one being explored by both fundamental experimental and computational studies, with theoretical efforts exploring far beyond the capabilities of modern instrumentation in order to direct future efforts.

## Mechanosynthesis and Mechanochemistry

The use of mechanical operations on chemical systems for the generation of new materials spans the range of synthetic chemistry, from nanoscale to macroscale. While no formal definition yet exists that delineates the generation of new materials via mechanical positioning and the generation of new materials via mechanical processing, these two approaches differ enough in scale and application that two broad categories can be used in the interest of differentiating

between them. Mechanosynthesis, the approach that employs mechanical positioning, provides for programmable control of materials at the atomic level and is the focus of this section. Mechanochemistry [Ref. 3], the approach that employs mechanical processing, is one primarily focused on macroscale manipulation of reactants or general materials. This mechanical processing can come in the form of experimental methods that generate forces that act on chemical systems (such as sonochemistry, shockwave chemistry, and material shear) or equipment that promotes chemical reactions directly in bulk by acting on the reactants (such as ball-milling [Ref. 4]).

## Similarities to Synthetic Chemistry

Conventional synthetic chemistry and mechanosynthesis are two different approaches to the manipulation of the same types of fundamental building blocks (atoms and molecules). Accordingly, while significant differences exist in how those materials are being manipulated, both approaches share design and implementation constraints based in the reactivity and stability of the reactants, with some of the similarities existing only for certain classes of chemical reactions.

## Chemical Reactivity

Both approaches involve direct atom-atom binding, or the formation of covalent chemical bonds. In solution-phase chemistry, chemical bond formation is achieved by the combination of two or more species to form a product with the ultimate goal being the formation of a new chemical species. The solution is responsible for delivery of the reactants and can be responsible for promoting the reaction. In mechanosynthesis, the formation of a chemical bond is directed by way of mechanical control of the placement of one or more reactants. The reported examples of various modes of placement and control are considered below.

## Specificity of Reaction Centers

Chemistry and mechanosynthesis share a design constraint of specificity in chemical reactivity for achieving a specific change in atomic connectivity. Unidirectional reactions can be designed in both cases, as can the reaction centers, or bond-forming regions. Reaction centers in mechanosynthesis, the positions where chemical bond formation are directed to occur, share similar design constraints as organometallic catalysts and enzymatic sites in chemistry and biology, including specificity in binding orientation and stability of the reactant binding over the course of a reaction (be it as catalytic or for deposition).

### *Local Atomic Precision in Assembly*

Just as idealized mechanosynthesis employs positional control and reactivity to drive the formation of a structure in a predictable, programmable manner, ideal synthetic chemistry employs appropriate ratios of reactants to form single products with complete conversion and no unwanted side products. While the bulk material of a product generated by chemical reactions may not be atomically-precise, chemical bond formation is inherently localized. This shared localization of reactivity is what makes both synthetic chemistry and mechanosynthesis amenable to molecular modeling studies that can explore the ground state geometries, deposition processes, and potential defect states/intramolecular reaction pathways.

### *Environmental Control to Optimize the Synthetic Process*

In both synthetic chemistry and mechanosynthesis, environmental control is a key factor governing the generation of a specific product. In both cases, this level of control is currently achieved through the macroscale manipulation of the environment, be it ultra-high vacuum conditions and cryogenic temperatures for the few experimental studies in mechanosynthesis or high-purity solvents and high temperatures in some chemical syntheses. In both cases, however, the environmental control need only be as stringent as the mechanisms governing reactivity. Biological systems, for instance, are defining examples of highly complex chemical reaction systems replete with varied chemical species that accomplish both synthetic and mechanosynthetic operations because the positional and enzymatic infrastructure is capable of differentiating between molecular species in chemical reactions. In stark contrast, experimental studies in synthetic chemistry and mechanosynthesis effort to remove as much complexity as possible in the interest of greater chemical control. This design-control philosophy is evident in the use of high purity solvents and starting materials in chemistry and ultra-high vacuum conditions used in the initial experimental demonstrations of mechanosynthesis.

### *Differences with Synthetic Chemistry*

The differences between synthetic chemistry and mechanosynthesis are pronounced both in terms of the delivery mechanism for nanoscale assembly from reactants and, importantly, the range of possible structures that can be generated due to differences in the control of the reactants and generated product. The key differences that reveal the utility of mechanosynthesis as a strategy for the controllable nanoscale fabrication of entirely new classes of manufactured materials not yet approachable by synthetic chemistry are summarized below.

The key feature of mechanosynthesis that makes possible the manufacturing of new materials still unapproachable by synthetic chemistry is positional control, the ability to either place reactants at specific locations for the step-wise assembly of new structures with control over the absolute positions of the reactants or the ability to position chemical functionalities with absolute control in order to promote or inhibit a chemical reaction at a specific location. The benefits of positional control in the fabrication of new materials are manifold.

### *Possibility of Predictable Assembly Rate*

As a process driven by the thermal motion of reactants, total reaction times in synthetic chemistry are orders of magnitude longer than the individual reactions themselves in order that appreciable quantities of product be generated. Mechanosynthesis offers the possibility of exactly calculating the time between both steps in the assembly process and the total time to product manufacture when the control over reactant delivery is also part of the mechanosynthetic process. Alternately, as found in biological examples, the delivery of reactants can be based on the thermal motions of molecules in the system, thereby offering specific information about the mechanosynthetic assembly process but only statistical control over the delivery of reactants.

Table 1 gives an overview of differences between chemistry and mechanosynthesis for key manufacturing processes.



**Table 1. Overview of differences between chemistry and mechanosynthesis for key manufacturing processes.**

Difference	Chemistry	Mechanosynthesis
Reactivity	Chemical reactivity is designed to be highly site-specific to maximize yield, maximizing predictability in products despite no physical control of the reactants. Side-reactions nonetheless typically limit yield	Uses positional control rather than requiring that reactions have inherent site-specificity. This enables the use of reactants that are more reactive and would, if freely diffusing, be less discriminating, as most side-reactions can be excluded by positional and orientational constraints. Mechanical energy can also be used to overcome activation barriers to chemical bond formation, enabling the use of less reactive starting materials
Range of possible structures	Specificity in covalent bond formation and atomic connectivity based on reaction design favors less highly interconnected products (floppy molecules, pendant group chemical functionalization), products typically limited by solubility of the reactants	Easier construction of polycyclic and highly cross-linked products, solubility of products is not always a requirement. Nanostructures can have, by mechanical positioning of reactants, far more structural complexity than would be available from conventional processes, which would require large differences in intrinsic reactivity among different locations on the structure
Control at reaction site	Steric interactions can favor orientation and binding position preference, high-energy environmental conditions (heat, photochemistry) can induce reactivity at specific positions, although higher energies generally make accessible pathways to unwanted products	Positional control can strongly enhance reaction rates at the intended sites by creating high "effective concentrations". This enables highly selective control of reaction rates, even in the presence of a background of diffusing, unbound reactants. Containment barriers in more complex systems can exclude such background reactants.
Results	New molecule formation with many structural similarities to the reactants	Extremely complex structures (thousands of monomers, multiple bonds per monomer) can be built from small reactive molecules

### *Benefit to Identical Reactants and Common Modes of Covalent Bonding*

Control of assembly in synthetic chemistry is ultimately governed by the design of the reactant. The use of steric bulk, polar functionalities, labile substituents, capping groups to inhibit reactivity at pre-existing functional groups, and highly strained and conformationally-restricted chemical bonding motifs all act to direct a chemical reaction to a specific location on a covalent framework. This can influence not only the choice of reactant given the constraints imposed by the reaction conditions of the chemical synthesis, but also the reaction design itself, as additional chemical modifications may need to be performed on a reactant in order to maintain control over the formation of a single product. In mechanosynthesis, the direction of chemical reactivity is also intrinsic to the reactant, but the resulting formation of chemical bonds in a structure is governed by the positioning of the reactant by external means. Effectively, provided the reactant and positional framework are not strongly interacting, it is possible to form

new structures and highly complicated geometric arrangements of reactants with virtually no differentiation of position on either the reactant or the material being manufactured. As a design consideration, a reliance on a specific reaction coordinate in a reactant and a reliance on positional control by a mechanosynthetic system favors the use of a single reactant for an entire assembly process. In this way, a delivery-and-deposition system can be optimized for a single molecule and positional scheme, the synthetic chemistry equivalent of a "one-pot, multi-step" reaction.

### *Positional Control of Assembly Without Chemical Direction*

The assembly of large molecules by synthetic chemistry is complicated by the need to engineer specific chemical frameworks to promote specific reactions. In effect, the role of chemical functionalities is to introduce a large "reaction asymmetry" into a molecule to promote a site-specific chemical reaction. Control and prediction of chemical reactivity becomes a considerable challenge in large molecules composed of similar building blocks. In large

molecules composed of molecular fragments with similar chemical motifs, the post-assembly modification of a final or in-process structure can be greatly complicated by the inability to select positional modification by thermal, solvent-based means. In even highly asymmetric molecules, all solvent-accessible regions may appear to be highly similar to a specific class of chemical reactant. In many areas of macromolecular chemistry, such as dendrimer chemistry, organometallic polyhedral self-assembly, polymer chemistry, and supramolecular (electrostatic-based) chemistry, many large molecules that appear to be ideal candidates for nanoscale fabrication approaches are not only highly similar in the reactivity of their molecular frameworks, they are also highly symmetric systems owing to the geometry of their structural fragments (linear chains of coordinating molecules, branching repeat units, small molecules with common binding motifs) and assembly motifs (coordination complex self-assembly, direct A-B covalent bonding chemistry controlled by the availability of accessible, reactive A and B groups, lock-and-key electrostatic binding modes in small-molecule supramolecular chemistry and biologically inspired host-ligand complexes [Ref. 5]).

In mechanosynthesis, positional control of reactants and workspaces enables the use of highly symmetric materials for the generation of highly complex structures. Counter to the requirements of many types of chemical reactivity for specific molecular structure formation, the need for either structural of reactive asymmetry is obviated by positional control in systems where a reactive center on a workspace is sufficiently isolated from other reactive positions. As a molecular building block approach to nanoscale fabrication, this absence of a need for structural differentiation in the reactant strongly favors the use of the same repeat motif and mechanosynthetic system.

### *No Separation or Purification of Product*

While chemical reactivity in synthetic chemistry is ultimately a function of the reactant, the preparation of a chemical species for a successful reaction can involve numerous steps to alter the covalent framework, the chemical environment, or both. A typical reaction sequence for the formation of a new molecule from three starting materials might involve chemical functionalization of the first two reactants separately, combination in the same chemical environment to promote a specific reaction, separation and purification of the new product from the supernatant, preparation of this new molecule and the third reactant, combination in the same chemical environment, and further separation of the final product. This lengthy series of steps is a result of utilizing known reactions with understood reaction mechanisms to accomplish very specific chemical tasks. In contrast, mechanosynthetic operations that employ the same repeat unit in a manufacturing process

rely on identical modes of reactivity and, in the absence of errors in the manufacturing process, the expectation of no unused or waste products. Provided a mechanosynthetic process can be designed that accomplishes a manufacturing task from the same fundamental building blocks, that process can be driven to completion in the absence of preparative or separation steps.

### *Atomic-Level Mechanochemistry, Forcing Chemical Reactivity by Proximity*

Demonstrated examples of mechanochemistry reveal that atomic-level modification of materials can be induced by macroscale mechanical processes. In ball-milling experiments, the transfer of mechanical energy into chemical bonds achieves the preparation of new materials in bulk. While the level of control in this mechanical processing is expected to be highly dependent on the reactants and choice of structural motifs, the sensitivity of chemical control in macroscale mechanochemistry experiments has not been explored in great detail. Such macroscale experiments are, as is common among mechanochemistry examples, still statistical in nature, with the system-dependent theoretical yield for such approaches determined by surface collision rates, itself a function of experiment times. The use of mechanical force to overcome reaction barriers in mechanosynthetic operations has already been demonstrated experimentally, where the mechanical positioning of a small, chemically-stable polymer and formation of a surface-to-polymer amide bond generates a structure strong enough to allow for retraction of the mechanical delivery system (AFM tip) [Ref. 6]. This simple demonstration is a profound addition to the list of benefits to mechanosynthetic operations over synthetic chemical approaches, indicating that assembly processes can be designed and performed using raw materials that may be otherwise chemically stable systems. In effect, a building block need not be highly reactive, but only contain a chemical functionality sensitive to the proximity of other functional groups. As demonstrated in the molecular factories of living cells, the raw materials for a complex nanostructure can be ubiquitous in solution and otherwise chemically inert, replying on site-specific mechanical activation to form covalent bonds between chemical functionalities that would not otherwise form due to high activation energies.

### **Landmark Studies in Mechanosynthesis**

The field of experimental mechanosynthesis is still in its infancy, with only a handful of published studies reported that show either mechanical positioning of atoms and molecules (by scanning tunneling microscopy and atomic force microscopy) or actual mechanical deposition to

form/reform covalent bonds. The reported experimental studies in mechanosynthesis have demonstrated very fundamental types of control (movement, placement, bond formation, bond breaking) at the atomic level. Despite the relative operational simplicity of the few processes thus performed in the laboratory compared to the vast number of synthetic chemistry approaches performed in that same time frame, the available mechanosynthesis examples all address, successfully, various key types of atomic manipulation control that can be envisioned as likely targets for nanoscale assembly by productive nanosystems.

**Eigler and Schweizer, Nature 344 (1990) 524.**

The first experimental demonstration of mechanical atomic manipulation using scanning tunneling microscopy to position Xenon atoms on the nickel (110) surface at 4 K. The design constraint employed in this experiment (the use of chemically non-reactive atoms on a metallic surface and cryogenic temperatures to exploit the weak electrostatic interactions between Xenon and nickel) is important because it shows that even extremely weakly interacting components can be assembled that persist over both assembly and characterization procedures. Such procedures may prove to be instrumental in nanoscale fabrication approaches that rely on small-area surface templating where inert dividers are required to maintain positional ordering of reactants and the dividers themselves must be readily evacuated from a surface at very low temperatures to maintain the stability of the in-process workspace.

**Hla, Bartles, Meyer, and Rieder. Phys. Rev. Lett. 85, 13 (2000) 2777.**

The formation of biphenyl on a copper (111) surface via the mechanical breaking of the iodobenzene carbon-iodine bond with tunneling electrons and mechanical positioning of the benzene radical into vicinity of a second benzene radical, all performed at 20 K. This first experiment demonstrated that chemical assembly is possible on a surface using positional control of the reactants. This mechanosynthetic experiment also employed a weak chemical bond (carbon-iodine) that could be broken readily while the starting molecule was still bound to the surface. This reliance on large differences in chemical reactivity to aid in the control of a multi-step assembly process is a common motif in synthetic chemistry.

**Oyabu, Custance, Yi, Sugawara, and Morita, Phys. Rev. Lett. 90, 17 (2003) 176102.**

Perhaps the first complete example of mechanosynthesis, a single silicon atom is removed from its lattice site on silicon (111)-(7 x 7), the surface scanned to confirm single-atom removal, and the silicon atom placed back at its original lattice position, all performed at 78 K. This study is the first complete demonstration of an entire mechanosynthetic process in correspondence with the many theoretical studies exploring single-atom and small molecule

manipulation under purely mechanical control. The removal and re-addition of a single atom into its original lattice site not only demonstrates that single-atom control is possible for even atoms strongly bound in their lattice sites, but also that the removal of single atoms and addition of new atoms into vacant lattice sites may be possible. Far beyond the placement of single atoms onto surfaces for patterning applications, this silicon mechanosynthesis study indicates that it may be possible to embed atomically-precise patterns into atomic lattices, thereby generating complex two- or three-dimensional structures that persist at moderate temperatures and for various nanoscale applications, including designer surface catalysis, surface templates for directing self-assembly, and molecular computation.

**Deshpande, Yildirim, Kara, Acharya, Vaughn, Rahman, and Hla. Phys. Rev. Lett. 98 (2007) 028304.**

A first example of a three-dimensional atomic disassembly of a small silver cluster on a silver (111) surface at 6 K using a scanning tunneling microscope. This study is significant as a demonstration of the capability of three-dimensional control of disassembly at the atomic scale. In effect, this study is the first to apply envisioned top-down approaches for manufacturing complex structures via bulk material disassembly at the atomic level, the same scale at which envisioned bottom-up approaches may begin their fabrication processes.

**Duwez, Cuenot, Jérôme, Gabriel, Jérôme, Rapino, and Zerbetto. Nature Nanotechnology 1 (2006), 122.**

Demonstration of a mechanical placement and bond formation of a simple organic polymer onto a modified silicon surface with retraction of the AFM tip and breaking of the AMF/polymer interaction, thereby leaving the molecule chemically bound to the surface at 295 K. This first demonstration of nanoscale mechanochemistry combines positional control of reactants with bond formation governed by proximity of otherwise stable chemical moieties. This finding is significant to near-term mechanosynthetic approaches to nanoscale assembly as it demonstrates the combination of positional control of reactants with understood reaction mechanisms to yield site-specific changes to a chemical workspace (here, a functionalized silicon surface).

## Selected Theoretical Work

Mechanosynthesis controlled by nanoscale systems, devices within several orders of magnitude of the feedstocks being manipulated, have been limited to theoretical studies that have explored either the design of mechanical components for performing such tasks or, more recently, the quantum mechanical study of the fundamental processes of atomic or molecular manipulation for performing mechanosynthetic operations. Computational studies addressing mechanosynthesis have focused almost

exclusively on either diamondoid mechanosynthesis, employing carbon dimers ( $C_2$ ) and numerous tooltip motifs to model deposition processes on diamond lattices, or hydrogen abstraction, the process of preparing a surface for the addition of feedstock by opening valences on surface atoms. Quantum chemical studies of mechanosynthetic depositions have only recently been possible at sufficiently high levels of theory to generate strong predictions about transfer energies and potential tooltip/feedstock defect structures. The processes being modeled by these studies involve levels of mechanical control only very recently demonstrated in the laboratory and employ chemical motifs that exist only indirectly in the chemical literature. Many of these studies anticipate improvements in experimental methods already demonstrated in the progression from atomic positioning of weakly interacting systems to the mechanosynthetic positioning of strongly bonding atoms. As the field of experimental mechanosynthesis is still exploring very fundamental research in atomic manipulation, the theoretical studies in diamondoid mechanosynthesis represent a unique instance of computation spearheading research design. The computational deposition studies reported to date are useful as organizational tools, as the chemical phenomena associated with transfer and deposition can be considered within the context of mechanical positioning, providing a framework for protocols that enable predictions of failure rates, transfer energies, and positional disorder in deposition processes. The development of protocols on small, high symmetry, and highly reactive systems based on computation is also of pragmatic benefit, as the experimental studies to date employ chemical structures significantly larger than modern quantum chemical studies allow the high-level modeling of.

**Dzegilenko, Srivastava, and Saini. *Nanotechnology* Vol. 9 325-330, 1998.**

This early study explores the use of carbon nanotube-based tooltips for performing diamond mechanosynthesis on a C(001) surface by way of molecular dynamics simulations with the Brenner many-body reactive potential.

**Merkle and Freitas, *J. Nanosci. Nanotech.* Vol. 3, pages 319-324, 2003.**

This study introduces the first exhaustive computational study of a carbon dimer tooltip for diamondoid mechanosynthesis based on the use of dimer stabilization with C, Si, Ge, Sn, and Pb-based tooltips.

**Peng, Freitas and Merkle. *J. Comput. Theor. Nanosci.* Vol. 1, pages 62-70, 2004; Mann, Peng, Freitas and Merkle. *J. Comput. Theor. Nanosci.* Vol. 1, pages 71-80, 2004.**

These two studies explore both dimer deposition and the dynamics of surface rearrangement on the diamond (110) surface, key first studies on the processes that may occur between mechanosynthetic operations.

**Allis and Drexler. *J. Comput. Theor. Nanosci.* Vol. 2, pages 45-55, 2005.**

A theoretical study on a carbon dimer tooltip that employs a strained  $\pi$ -electron motif to both allow for covalent carbon dimer binding (breaking aromaticity) and energetically favorable dimer deposition (through the use of  $\pi$ -system reformation to remove unpaired spins).

**Temelso, Sherill, Merkle, and Frietas. *J. Phys. Chem. A* Vol. 110, pages 11160-11173, 2006.**

The most computationally exhaustive study of hydrogen abstraction to date, this study explores the use of the ethynyl radical for performing hydrogen abstraction on isobutane, a model system for the diamond (111) surface.

**Peng, Freitas, Merkle, Von Ehr, Randall and Skidmore. *J. Comput. Theor. Nanosci.* Vol. 3, pages 28-41, 2006.**

This work reports the first quantum chemical simulation of dimer deposition onto a diamond (110) surface using Si-, Ge-, and Sn-tooltip motifs based on a previously-reported DCB6 dimer placement structure.

**Freitas, Allis and Merkle. *J. Comput. Theor. Nanosci.* Vol. 4, pages 433-442, 2007.**

A tooltip survey of potential germanium-containing carbon dimer tooltips exploring binding energies and defect structure formation among a number of carbon framework motifs.

## References

1. Gresser, Myers, and Boyer. *J. Biol. Chem.* 25 (1982) 12030.
2. Rodnina, Beringer, Wintermeyer. *Trends in Biochem. Sci.* 32 (2007) 20.
3. Todres, Zory Vlad. *Organic Mechanochemistry and Its Practical Applications.* CRC Press. 2006.
4. Balema, Wiench, Pruski, Percharsky. *J. Am. Chem. Soc.* 124 (2002) 6244.
5. Allis and Spencer. *Nanostructural Architectures from Molecular Building Blocks. Handbook of Nanoscience, Engineering and Technology,* 2nd Ed. (CRC Press) 2007.
6. Duwez, Cuenot, Jérôme, Gabriel, Jérôme, Rapino, and Zerbetto. *Nature Nanotechnology* 1 (2006), 122.



## Patterned ALE Path Phases

### Background

A promising approach to building atomically precise structures is to use Patterned Atomic Layer Epitaxy (ALE) to grow precisely defined structures in crystalline silicon, on a single-crystal silicon substrate. The semiconductor industry has long been able to grow atomically precise structures vertically, using ALE or similar approaches to deposit a variety of materials with sub-monolayer precision. Semiconductor lasers and mirrors exploit this control to define quantum well structures comprising tens or even hundreds of precisely determined layers. However, using photomasks and light to control lateral dimensions on the wafer results in considerably lower resolution for structures in the wafer plane.

A Scanning Tunneling Microscope (STM) enables us to pattern planar features with atomic precision, as shown by Lyding.<sup>1</sup> This approach starts with a hydrogen passivated silicon surface in ultra-high vacuum (UHV), selectively removes hydrogen from programmed sites on the surface with the STM tip, and then floods the surface with a gas that sticks only in the de-passivated regions. With the proper chemistry, that reaction is self-limiting, leading to one atomic layer of deposition in the de-passivated portion. Further growth can repeat this sequence with the same or a different gas. In principle, multiple layers could be grown by multiple gas cycles per each STM patterning operation, leading to increased throughput.

The remainder of this section discusses pathways to commercially viable Atomically Precise Manufacturing using patterned ALE.

### *Phase 1: Single STM Si Patterned ALE – Low Throughput*

Phase 1 of Patterned ALE will be a single crystalline material process (Si is a leading candidate) that will be patterned with a single Scanning Tunneling Microscope (STM). The ALE process is likely to have a moderately long cycle time. The process will have a very low throughput but will be able to create products of value that take advantage of the atomic precision of the structures that are created.

To be useful, the atomically precise structures created in Si or other materials must be stable in the environment that

they would be used in. For Si, the standard passivating layer is SiO<sub>2</sub>. However the thinnest stable SiO<sub>2</sub> layers are approximately 1 nm thick, which would not be suitable for some of the desired applications. Hydrogen passivation is not terribly stable in ambient conditions. It would be desirable to develop a stable monolayer for passivating Si. Several possibilities exist including methyl groups, acetylene, and ethylene.

### *Phase 2: Pattern Once, Turn ALE Crank – Dual Material ALE (Si/Ge)*

Phase 2 will significantly improve the throughput of patterned ALE by removing the requirement of de-passivating every bond where an atom or molecule is to be added.

For Phase 2 Patterned ALE, there is a need for passivation layers and de-passivation processes that are selective. For a Si process two different passivation layers would be required, one (passivation A) that is a robust mask that can be patterned with Atomic Precision and would be stable while an ALE process that used a different passivation chemistry (passivation B) was used to deposit Si in that patterned area. Part of that requirement would be for passivation B to be cleanly removed from the Si surface repeatably (every ALE cycle) with some global de-passivation process while not removing passivation A.

One technique involves using two different passivating species, where one may be selectively removed without disturbing the other. For instance, both Cl and H will successfully passivate Si (100) surfaces. H will desorb from the Si surface at lower temperatures than Cl. By using the patterned Cl layer to first passivate a Si surface, ALE may be used to grow Si in that patterned area. If the ALE process is one that uses hydrogen as the passivating chemistry, then the ALE process may be continued without additional patterning by using temperature as the de-passivating process for the H passivated Si. Because the Cl will remain in place, then the ALE process will only grow Si in the area that was originally patterned in the Cl passivation layer. The process may be continued for as many deposition cycles as desired for that pattern. Control of the growth on the sidewalls of the ALE grown structure may be an issue.

A Dual Material ALE process could also have a reduced patterning requirement as well as a number of other advantages. Consider an atomically flat section of Ge (100) that was passivated with some species that can be patterned. An ALE process is used to deposit a monolayer of Si in the patterned layer. (Note that heteroepitaxy of Si on Ge and Ge on Si has been established with ALE processes.) At this point a dual material ALE process could be used to

<sup>1</sup> Lyding, J. W., Hess, K., Abeln, G. C., Thompson, D. S., Moore, J. S., Hersam, M. C., Foley, E. T., Lee, J., Chen, Z., Hwang, S. T., Choi, H., Avouris, P. H., and Kizilyalli, I. C. (1998), "UHV-STM Nanofabrication and Hydrogen/Deuterium Desorption from Silicon Surfaces: Implications for CMOS Technology," *Applied Surface Science*, 130-132, p. 221.

selectively deposit Si on Si and Ge on Ge where the cyclic process would alternatively deposit a monolayer of Si and a monolayer of Ge. In this way the growth surface would stay atomically flat and there would be no sidewalls to contend with. After a designed number of deposited monolayers, the pattern could be changed and complex 3D heterostructures could be created. Since there are very selective etches to remove Ge, the Ge material could be used as a sacrificial layer, allowing for releasable 3D structures.

A passivation layer is a monolayer of atoms or molecules that protect all available bonds on a surface so that it is stable and non-reactive. A monolayer that satisfies all available surface bonds is preferable, but in principle one that "protects" all surface bonds through a combination of bonding and steric hindrance might be acceptable. In this context the passivation layer only needs to be stable enough to enable an ALE process.

A dual material ALE process such as Si/Ge would be able to create releasable complex 3D structures. Adding other materials such as diamond, one or more metals, and one or more dielectrics would greatly expand the variety of products that could be made. Additionally the ability to add impurity atoms (dopants) to modify the properties of the ALE deposited materials would allow experimental manufacture of specialty electronics, such as quantum bits.

### *Phase 3: Parallel STM (modest parallelization)*

Even with dual material ALE capabilities reducing the amount of patterning that needs to be done by an STM tip, the throughput will be extremely limited. Phase 3 of patterned ALE would include a modest number of STM tips operating in parallel to do the atomically precise patterning. In this context, a modest level of parallelization would be on the order of 1000 or less. With only 1000 parallel operations, we can have close to 1000 times the throughput of the simple system at nearly the same manufacturing cost. High value products that were commercially viable with the single STM head become very profitable, and new classes of products become feasible at this level of parallelism.

Because each tip will need atomic precision capability, it is unlikely that a fixed array of tips can be scanned in unison. There will be the need to make at least small individual adjustments to assure each tip is on some grid that is commensurate with the lattice that it is patterning, but independent scanning capabilities for each tip can also be used to improve throughput and flexibility in patterning. Engineering the desorption process to deliver near-100% yield is a prerequisite for parallel manufacturing.

To maximize throughput, flexibility, and reliability, we need closed loop 3DOF (XYZ) positioners with at least 0.1nm precision, a footprint (in the plane of the array) of less

than 4mm<sup>2</sup>, and as large a percentage of footprint, X-Y scan capability as possible. The scanner should be a module that is used to build an array, and should be replaceable. If possible the tip should be replaceable. Each scanner should be independently operable. Control of the voltage potential of the tip is also required.

A system that includes a global coarse positioning system and a modest sized array (1000 or less) of the scan modules needs to be built that can effectively pattern large areas with atomic precision depassivation lithography.

### *Phase 4: Moderately Parallel STM - Nanoimprint Replication*

In Phase 4 of patterned ALE there would be moderate parallelism with an array of STM tips to do atomic precision patterning. In this context moderate parallelism would mean greater than 1000 tips up to about 1,000,000 tips. The ability to replicate atomically precise (or near atomically precise) templates created by these arrays would be developed via nanoimprint technology.

This phase represents mostly engineering refinement of previous work. The error rate of desorption and subsequent deposition would need to be extremely low. The precision of the STM would need to be improved, and some local intelligence for the STM would become mandatory.

### *Phase 5: Template Based Patterning - Epitaxial Metals and Insulators*

Phase 5 patterned ALE would use templates to passivate or depassivate surfaces to dramatically speed the patterning process. The atomically precise templates will be created by patterned ALE using the arrays of STM tips available from Phase 3 or 4. Phase 5 would also develop metal and insulator deposition that was epitaxial with the other materials being deposited. Maintaining a continuous crystalline structure would have benefits for a number of applications.

With atomically precise templates, and some improved chemistry, the parallel transfer of a monolayer of passivating atoms or molecules can take place onto or off of the growth surface. This will replace the serial patterning by STM tips. The passivating layer need not be the same one as is part of the ALE cycle, but it would be advantageous if they were one in the same.

The challenge of keeping the registration of the template to surface to the accuracy required to maintain atomic precision patterning will increase with the area of the pattern being transferred. Therefore, the template areas may need to start off small, but should increase as the technology is improved providing a large improvement in patterning throughput.



## *Phase 6: Functional Nanosystem - Atomically Precise Nanoscale Pico Positioner Assembled from Atomically Precise Parts*

Atomically precise parts made with patterned ALE can be used to assemble more complex and useful mechanisms. AP parts produced with patterned ALE using at least two different materials will enable the design of near-arbitrary 3D structures. Assembly of these parts could be handled in early stages by microscale positioners. However, the mechanisms produced by this bootstrapping process could be designed to assemble the next generation of atomically precise parts into larger and more sophisticated systems. Such systems would benefit from those atomically precise parts by being more precise than micro-scale systems, enabling a greater degree of parallelism and higher engineering yields. These systems would also benefit from bootstrapping – the parts would be manufactured with precision in 3D at a relatively low cost as parallelism was increased.

## *Phase 7 – Productive Nanosystems Based on Programmable Nanoscale Pico Positioners*

Phase 7 is a Productive Nanosystem (PN) based on complex nanoscaled machinery built from Phase 6 capabilities. A starting target PN is a programmable instrument that can do patterned ALE or some other form of atomically precise manufacturing. Programmability allows it to be used to build parts for other programmable nanoscaled machines that can produce more programmable nanoscaled manufacturing machines. Through exponential assembly, a very large number of these productive nanosystems could be produced. Once significant quantities of these are produced, they can be programmed to produce other atomically precise articles of value with a throughput which is arbitrarily large.

## **Product Roadmap**

The output of individual productive nanosystems doing manufacturing is likely to be limited to relatively small scale objects in the early stages. It is likely that larger scale systems will be required to assemble atomically precise components into larger structures. It is anticipated that several size scales will need to be covered by these assemblers.

Surprisingly, the extremely limited throughput of a technique that used an STM for patterning would still support a profitable manufacturing capability. Several applications have been identified that could exploit the unique atomic resolution capabilities to create key components in commercially viable products. Nanopores for

DNA sequencing and atomically precise metrology standards are two examples of such products. However, if patterned ALE were restricted to a slow serial approach its payoff would be very limited. This limitation is by no means fundamental. Atomic resolution patterning could be parallelized by several means. A large number of STM tips operating in parallel is one path. Atomically precise masks (created by patterned ALE) to do the patterning is another approach. In the long run, the highest throughput would be provided by nanoscaled patterned ALE tools, which would be productive nanosystems.

## *Phase 1 – Single STM Si Patterned ALE*

### **Metrology Standard**

VLSI Standards is a company that supplies metrology standards to the semiconductor industry. They supply a wide variety of standards that cost several thousand dollars to several tens of thousands of dollars apiece. Most of these are NIST traceable; none are atomically precise.

Simple atomically precise Si artifacts such as a wall of silicon a known number of atoms wide and tall would be an excellent CD standard for SEMs or AFMs. Several other atomically precise standards could be produced. The cost of producing a single metrology standard even with a single STM tip doing the patterning could be easily under \$1000. The principle cost of metrology standards is the metrology to assure that they are the size they are supposed to be. In this case, the tool that makes the standard could verify the size simply by imaging the structure and counting the atoms. Although this is a small market, it is an important one; metrology is vital to manufacturing.

### **Molecular Binding Sites**

With the ability to sculpt a surface with atomic resolution, and the ability to stabilize the surface while preserving atomic precision, it should be possible to design molecular binding sites for specific molecules. These binding sites could be used in lock and key molecular sensors where relatively simple means could be used to detect the presence of a bound molecule. To keep the sensors from fouling, the residence time of a molecule in the binding site could be engineered. It would not take many binding sites to make such a sensor.

### **Catalyst Research**

One description of a class of enzymatic catalyst is a molecular binding site for the transition state of a specific reaction. Discussions with enzymatic catalyst experts have led to uncertainty with respect to whether spatial confirmation would be enough. Some suggested that charge confirmation would be required as well. Site specific functionalization of a designed atomically precise surface

structure might provide the charge confirmation. Using a single STM tip would not produce enough catalyst sites to be commercially viable, but the research into artificially designed catalysts, which would be a product of later phases, would be enabled.

### *Phase 2 – Dual Material ALE (Si/Ge)*

#### **Atomically Precise NEMS**

With the dual material Si/Ge patterned ALE capability, releasable, atomically precise Si structures could be used to make high frequency, high quality factor, nanomechanical resonators that would have significant applications in low power radio, as well as other applications.

#### **Nanopores for Molecular Filtering**

The availability of a sacrificial layer means that designed pores for very specific molecular filtering would be possible. These filters would be expensive when produced with a single STM tip, but could be a key enabler for specialized micro/nano fluidic reactions that could pave the way for more widespread use of lower cost molecular specific filtering.

### *Phase 3 – Parallel STM (Modest Parallelization)*

#### **Nanopores for DNA Sequencing**

With the addition of patterned metal, nanopores with the specific task of sequencing DNA can be produced. There are currently many researchers working to develop DNA sequencing with a nanopore approach. Estimates of bases/sec in a single pore run from 1,000 to 1,000,000. A modest array of these pores could read an individual's complete genetic code in minutes. A sophisticated system would be required for this sort of throughput and reliability, but the atomically precise nanopores would be the enabling technology.

#### **Advanced AP NEMS Resonators, Filters, Densors, etc.**

The addition of patterned deposition of metals and insulators, even if they are deposited with ALD and not necessarily atomically precise, would still enable many more sophisticated devices and sensors. Nano Electro Mechanical Systems (NEMS) would be a clear winner that could be produced with the improved throughput of the arrayed STM tips.

#### **Lock and Key Molecular Sensors**

With integrated electrodes, single molecular binding sites become lock and key sensors. Sensitivity and reliability can

be scaled with array size. Array patterning capabilities will drive the cost per sensor down.

#### **Quantum Bits**

Quantum computers are being researched worldwide for applications in cryptography and advanced computation. These require quantum bits (Q-bits) to perform computation. With dopant placement, insulator deposition, and patterned metal deposition with atomic precision, the Kane Q-bit (P atom in Si Matrix) becomes a real possibility. A research group in Australia is currently developing such devices. A production-oriented parallel STM system would enable that technology to become mainstream.

### *Phase 4 – Moderate Parallel STM - Nanoimprint Replication*

Nanoimprint lithography can cost-effectively replicate nano-scale patterns in a variety of materials. Making a high-quality nanoimprint template has been challenging, requiring use of very expensive SEMs to get down merely to 10nm size features. With a reasonable sized array, atomically precise, or near atomically precise nanoimprint templates can be made for a number of applications. We do not expect early APM systems will be able to make templates of a size and complexity required for semiconductor manufacturing in the near term, but there are many other valuable applications.

#### **AP Optical Elements**

Atomically precise sub-wavelength diffraction optical elements will have unprecedented optical performance. Filters with extremely tight band pass and band block performance will be possible as well as a host of other superior optical elements that will be produced very economically because of high throughput printing capabilities.

#### **Molecular Filter Membranes**

The highly specific molecular filters produced at high costs in Phase 2 will now be many orders of magnitude cheaper because of low cost replication through nanoimprint.

#### **Chiral Surfaces for Drug Enantiomer Separation**

In addition to membrane filters, surfaces sculpted with atomic precision for specific molecular interaction can be used for a wide variety of chemical and pharmaceutical processing. One example is chiral surfaces for drug enantiomer separation.

## **Catalysts**

Although research will be required to establish this capability, large area catalytic surfaces may be possible by using nanoimprinting with atomically precise templates.

### *Phase 5 – Template Based Patterning - Epitaxial Metals and Insulators*

Masked AP template patterning capability provides a dramatic improvement in cost effectiveness of production. This will expand the markets of all previous products.

With epitaxial metals and insulators to go along with silicon and potentially other semiconductors comes the ability to make sophisticated, electronic, mechanical, and photonic devices.

The multi material sophistication will allow the first devices that we might herald as productive nanosystems.

### *Phase 6 – Functional Nanosystems*

Many products and applications will be possible and are surely outlined in other sections of this roadmap. The most important may be realized by the ability to generate a variety of inorganic materials with atomic precision. These will allow the creation of productive nanosystems in Phase 7 that will be the factories that allow a wide range of atomically precise products at ever decreasing costs.

### *Phase 7 – Productive Nanosystems*

The range of atomically precise products produced by these systems has been addressed by others. We note that the economic value produced by these systems will be immense, but the exact products are hard to forecast accurately.



## Numerically Controlled Molecular Epitaxy (Atomically Precise 3D Printers)

### Background and Overview

In the macroscopic world, the increasing availability and sophistication of “3D printers” or solid freeform fabrication machines is revolutionizing several fields of manufacturing, including rapid prototyping, model building, and even sculpture. Typically, such machines are numerically controlled epitaxial engines: they deposit successive layers of working material (and sometimes sacrificial scaffolding material) to form a target object.

Current top-down positioning and manipulation technology is easily capable of the spatial resolution necessary for epitaxial fabrication at the molecular scale, given a methodology for deposition. We define “numerically controlled molecular epitaxy” (NCME) as the process depositing of atomically precise building blocks—typically molecules—so as to build an atomically precise product. NCME is an intermediate technology, more restricted than fully mature mechanosynthesis, but nonetheless capable of a wide range of useful products, possibly including mechanisms themselves capable of NCME.

The requirements for an NCME system include a source of molecular building blocks, a 3 degree-of-freedom manipulator, and mechanisms for attaching and releasing blocks to and from the manipulator. (Ultimately mechanisms for removing the finished product from the manipulator's work envelope and deploying it would be required, but we shall ignore this in the following.)

In operation, the manipulator acquires an atomically precise building block, moves it to its intended position, and releases it, causing or allowing it to be bonded to the growing workpiece. Specifics of the acquisition, release, and bonding mechanisms will vary as the system of building blocks.

First-generation NCME systems will employ macroscopic positioners, either piezoelectric as in current scanning-probe practice or mechanical; currently available linear actuators have sufficient precision for this application. Building-block acquisition and release are likely to be electrically modulated, inducing redox interactions between manipulator tip and building block.

Blocks themselves are likely to fall in the range of 1 to 100 nanometers, depending on provenance and application. Early systems might use bio-derived macromolecular structures of DNA, RNA, and/or protein. Products of such systems could assist in the synthesis of second-generation blocks with enhanced precision or functionality.

### Enabling Technologies/Developments

Precise positional manipulation of small molecules and individual atoms has been demonstrated by macroscale (AFM, STM) techniques, meaning the NCME approach benefits from “proof of principle” employing building blocks far smaller than necessary for the fabrication of complex and functional nanosystems. From these original demonstrations, it is determined that enabling technologies leading to NCME must include developments in (1) tooltip design and building block manipulation, (2) building block design and interaction, and (3) tooltip-building block interaction and positional control.

#### *Tooltip Design and Building Block Manipulation*

The tooltip is required to bind or otherwise constrain a building block, position the building block in a manufactured structure, and release the building block; it must then be removed from the structure. A useful tooltip must be (1) predictable in its binding/constraint method, (2) accurate and repeatable in its positioning, and (3) stable to chemical reactions with the building block; a possible extension of these characteristics is (4) capability of positional control in more than one dimension or direction (a structure may be built linearly, or the fabrication stage may include rotational/translational motion to enable fine control of building block positioning). The positioning resolution of the tooltip need not be atomically precise, given a sufficiently large building block with compliant bonding properties. For instance, a tooltip may provide the positional flexibility to allow for the building block to sample its own PES in the vicinity of its final position. Further, the monolithic tooltip motif may not be the most advantageous, especially in a system where numerous building blocks with different binding properties must be manipulated. Interfacial structures, such as dendrimers, proteins, or DNA structures, may be used that provide a specific binding interaction on the building block side and strong tooltip/interface interactions to the tooltip while also being removable and/or replaceable through chemical/electrical means.

#### *Building Blocks*

As a manufacturing feedstock, a building block incorporates a binding interface to other building blocks, a binding or other positional interaction (such as mechanical constraint) to a tooltip, and some means to interacting with the delivery medium (solution, surface mounted, part of a



larger building block feedstock) while being rigid enough to persist through the steps involved in delivery and positioning. Classes of known molecular materials that achieve discrete structure sizes in the 1 to 100 nm regime include proteins (natural and synthetic), DNA/RNA, dendrimers, supramolecular structures (hydrogen-bonded, coordination complexes, etc.), and inorganic macromolecules. These classes of potential building blocks can be divided into many categories that differentiate them based on symmetry, rigidity, synthesis, etc. As a building material of nanoscale structures, the two most useful distinguishing features are symmetry and rigidity (building block generation need not be a criterion in the NCME process provided the material can be obtained). Asymmetric structures offer the greatest potential for specificity in building block binding interactions and positional control, but require the most accurate positioning tools to guarantee proper placement. Symmetric structures may be easier to place (if no orientation preference exists) but are more difficult to orient. Biomolecules are less rigid than can be achieved by synthetic organic methods (because flexibility of the structure is the key to solution- phase conformational searches), while the synthesis of rigid organic frameworks is still an area of fundamental research. Dendritic structures and Platonic solid coordination complexes offer a compromise of rigidity, synthesis (such structures can be generated spontaneously in solution from their parts, while proteins and DNA require cellular machinery to be assembled), and symmetry with some degree of local asymmetry to direct positioning/binding.

## Tooltip/Building Block Interactions

The tooltip/building block interaction must meet a number of criteria based on the tooltip/block interaction motif. Such motifs include electrostatic interactions (the generation of a binding surface on both parts that lead to fixed position or orientation upon binding), mechanical grappling (using steric constraints to hold a building block and restrict its motion), and covalent attachment and disassembly (where chemical bonds are made and broken during the delivery and/or deposition process). The interaction design must meet a number of criteria in a physical positioning or placement process, including tooltip/building block binding stability (preferential binding and orientation of the building block to the tooltip), nondestructive release of the building block from the tooltip at the workspace (perhaps through tighter binding of the building block to the workspace than to the tooltip), and controlled delivery of the building block to the tooltip (through surface collection of the building block, synthesis of the building block on the tooltip (seed), solution-phase delivery of the building block to the tooltip, or mechanical positioning of the building block to the tooltip from another device).

## Metrics for Building Blocks

As building materials approaching the size regime of their constituent parts (single atoms or small molecules), building blocks can be divided in their usability by size and functionality. In most molecular building blocks, a defined geometric shape can be readily altered in size by the change in length of the components. In DNA-based blocks, the size of the block is limited by the number of base pairs required to stably form some geometric shape (such as a corner or loop), after which the length of the object can be altered simply by adding base pairs (the distance between base pairs introducing a spatial quantization in the sizes of all blocks). In coordination nanostructures, the organic ligands that make up the sides or faces of a Platonic solid can be modified by the addition of fragments, thereby providing a chemical control of block size during the initial component synthesis. The size of a dendrimer can be changed by similar methods. After a first build block is proposed and synthesized, a natural extension of the work is the generation of a family of structures identical in shape by differing in length/volume.

In general, smaller building block sizes yield greater control over the shape and dimensions of a nanoscale assembly. Currently, building blocks as small as single atoms have been demonstrated to be capable of being manipulated, although such control has not yet been applied to the fabrication of even simple nanoscale systems. The preference for small building blocks must be balanced against the most advantageous size that can be manipulated by NCME methods (which will change as a result of developments in related fields). The size of the building block is directly related to the precision of the fabricated object (tolerances are a result of both the ability to generate a part and the mechanical properties of the generated part) when a desired connectivity is assumed. In cases where pieces only require proximity (such as chemical reaction arrays), high precision in construction is not as important. In assembled nanodevices from building blocks that must work within physical, mechanical, thermal, etc., tolerances, the balance between building block size and interaction strength is critical.

Functionality (chemical, interactions) is introduced as a result of atomic arrangements in molecules or building blocks and requires a minimum number of atoms to achieve it. This restriction places a lower limit on the size of a building block for NCME applications. In theory, many kinds of functionality can be achieved with a minimum number of molecular fragments, placing the introduction of useful functionality towards the 1 nm limit of the proposed building blocks. Further, functionality need not be a result of a single block, but can involve multiple blocks in close proximity (such as is the case in a folded protein). Building block functionality also incorporates the interaction motifs between building blocks to generate larger structures, with



the variety of interaction motifs responsible for greater variation in assembly. An important goal in building block generation is the determination of the various forms of functionality (assembly, application) that can be incorporated into a building block. A specific goal is the introduction of maximum functionality into minimum building block size.

A number of useful metrics are related to the application of nanostructures generated from positioned building blocks that pertain to the bulk properties of the nanostructures as well as the constituent building blocks. Properties include (1) the tensile strength of the structural components (a function of both the building block and the interactions between building blocks), (2) the conductivity of the assembled structures and building blocks (which can be designed at the building block scale to be insulators or conductors), (3) electron mobility in semi-conducting building blocks, and (4) the coefficient of friction between bearing faces or interacting building blocks. In all cases, feature optimization can be performed at the building block level, and development directions can include the establishment of goals for property optimization as a part of fostering new building block designs or determining fundamental limitations of the building blocks themselves.

## Metrics for Manipulators

The NCME approach, by design, overcomes many of the fundamental limitations on nanoscale manufacturing (such as the generation and positioning of highly reactive species, defect structure formation in bonds requiring high energies to correct, etc.) that reside in mechanosynthetic routes by employing numerous weaker interactions between stable building blocks that are synthesized in steps prior to assembly. In many respects, the metrics governing the development of manipulators at the nanoscale mirror many of the same at the macroscale.

### *Speed of Action*

A manipulator obtaining building blocks from solution will ultimately be limited by the concentration of the building blocks and the viscosity of the medium, which will also place constraints on the speed of motion of the manipulator. The removal of the manipulator from the in-process nanostructure will require delays in building block positioning, any motion of the building block to find its minimum energy position, the time to achieve building block release, etc.

### *Precision*

The binding of building blocks is a function of energy and separation. A sufficiently aligned interacting pair will align

themselves, a feature that removes the highest-level need for precision in a manipulator. Precision in position and orientation are required for the assembly process as geometric, functionality constraints introduce numerous local minima in an assembled structure, especially in cases where no medium (water) exists for reducing the binding interactions at local minima.

### *Degrees of Freedom*

The mobility requirements of a manipulator will vary with the number of manipulators being utilized and the positional flexibility of the workspace (or the fabricated structure. The formation of the solid frame may result in physical motion as fragments bind together).

### *Work Envelope*

The accessible region of the manipulator for building block positioning. Phase-space analyses provide useful first estimates of the positional freedom of a manipulator, which then defines positional constraints on the workspace. In nanoscale fabrication, the work envelope is coupled to both the degrees of freedom of the manipulator and the steric hindrance at the site of building block placement.

### *Steric Hindrance*

The size of the manipulator tip will determine many aspects of the fabrication process. While the use of building blocks removes much of the reactivity associated with the positioning of structures, workspace/manipulator clearance may prove to be a limiting feature of a nanostructure design incorporating complex building blocks and 3D assembly approaches. Steric limits to nanostructure fabrication decrease with increasing tooltip specificity for a building block or standard building block size. The generation of tooltips with profiles equal to (or smaller than) the building blocks removes steric limitations at the point of building block deposition.

### *Orientation Specificity*

With asymmetric building blocks or high symmetry building blocks with some form of directionality in their connectivity, the manipulator must either bind the building block with high orientation specificity and deposit the building block with spatial (orientation and position) specificity, or must bind the building block in such a manner that the profile of the binding position on an assembled nanostructure will direct the insertion of the building block.

## *Accuracy*

Positional fabrication of nanostructures by building block approaches requires placement of building blocks within close proximity of the binding sites. For a given interaction motif (surface binding, electrostatic interactions, steric lock-and-key methods, etc.), a building block in close proximity to a binding site may position itself based on the formation of new interactions. In fabricated structures where interacting surfaces are numerous and no clear means to subunit migration are possible to achieve maximal binding, the building block delivery to a specific position on an in-process nanostructure must be accurate to within some defined tolerance that corresponds to the interaction region between building block and workspace.

## *Repeatability*

The fabrication of complex nanostructures from the mechanical manipulation of molecular building blocks requires both accuracy and precision in the deposition of each block. The same degree of control is required over the course of multiple positioning steps in a fabrication process, meaning that repeatability of building block positioning and deposition is a third feature of positional control required for successful fabrication.

## *Feedstock acquisition*

A key factor in overall deposition speed is the method by which the building blocks are provided to the manipulator, e.g. solution, surface, fabrication on the tooltip, etc. An appropriate figure of merit for this function is simply latency: the time taken to obtain the next building block (lower is better). This is a figure that can be expected to change by many orders of magnitude over the course of NCME development. Early-generation systems which require macroscopic operations (such as solution washout and replacement) for successive building-block types may give way to microscopic in-situ building block synthesis, perhaps directly on the tooltip itself.

## *Stability of the Tooltip (or Manipulator)*

The purpose of the tooltip is the binding, delivery, deposition, and retraction from a nanostructure. Accordingly, the tooltip should persist in a non-reactive/non-destructive form over the course of a positioning event. Again, the NCME approach (the use of building blocks instead of reactive subunits) is meant to remove issues associated with high-energy defect structure generation. Tooltip persistence is achieved, as a manufacturing component, through the use of non-destructive binding interactions to the building blocks. The breaking of the

manipulator/building block interaction upon placement may be a result of either the energy of the block binding interaction in the nanostructure being higher than the manipulator/building block interaction or the use of some chemical, electrical, mechanical means of weakening the tooltip/block interaction.

## *Applications*

At the macroscale, the products of solid freeform fabrication are typically aimed at low-volume or one-off applications, such as prototyping or custom designs. The products of NCME will likewise be best utilized in roles that are low-volume by chemical standards.

A particularly important use for products of early-generation NCME will be as enabling technology for later-generation NCME. (There will of course be crosstalk with other approaches to productive nanosystems as well.)

## *Filters and Catalysts*

DNA-based building blocks will tend not to have fine enough control of shape to produce catalysts, but protein-based ones certainly can. In either case, NCME may be able to produce a filter that will aid in separation or purification of building blocks produced by conventional chemical or biomolecular synthesis. Similar filters would be more broadly useful in other experimental applications.

It might be possible to form filter or catalytic sites from the juxtapositions of corners and edges of building blocks using the positional capabilities of NCME, even in those cases where the building-block synthesis technology cannot form them directly. In other cases, for example the formation of larger DNA mats with “staples,” the product of synthesis is a scattering of partial, folded, and/or inverted building blocks as well as “correct” ones. NCME would then be used to assemble or patch a regular or patterned monolayer.

## *Molds and Stamps*

It might be possible to produce atomically precise or nearly atomically precise scanning probe tips by, for example, creating molds in an early-generation NCME technology and filling them using electrodeposition. Such tips are necessary for higher-precision NCME as well as a significant desideratum for surface science and experimental nanotechnology generally.

In later generations of the technology, molds might be used to produce stamp building blocks that, assembled by NCME, could be used in productive machinery in a manner reminiscent of Gutenberg's movable type.

## *Circuits*

Given just conducting and insulating building blocks, molecular-scale electric circuits could be laid out, including such components as capacitors, resistors, and ground planes. Given an additional one or two semiconducting block-types, transistor and complementary transistor circuits, respectively, could be built. This would allow the construction of circuitry ranging from nanoscale RFIDs to motor controllers to computers.

## *Structures and Mechanical Systems*

Given blocks of sufficient stiffness and bonding strength, shapes could be produced that were useful chassis, frames, tanks, pipes, or mechanical components.

Static structures could include vessels and channels for chemical processes. If the building-block set allowed for catalysis, this could be included in reaction cascades that could offer enhanced reaction speeds and specificities. Steric constraints in such reactors could allow, for example, custom dendritic structures to be synthesized that were difficult or impossible in free solution.

Systems with moving parts would be facilitated by blocks with low-friction, high-stiffness bearing faces that could be used to compose rotary bearings or linear sliders.

Actuation of such systems, linear or rotary, could be done by electrostatic interaction in circuits such as previously specified. Such designs would be facilitated by a block containing an embedded charge or dipole moment.

An XYZ (3 degree-of-freedom) manipulator arm seems feasible in a moderately sophisticated system of such components. Such a device can be designed using structural elements, circuit elements without the need of transistors, and sliding interfaces without the need of rotary bearings. Such a device would, if properly designed, be capable of operating with the same blocks and tolerances of its own construction.

In a more sophisticated building-block system, it might be possible to construct an electrically-controlled selective polymerizer, which would function as a directly-controlled ribosome. This would allow for the synthesis of a wider variety of custom building blocks, which would in turn allow for the construction of more sophisticated machines, and so forth.



# Scanning Probe Diamondoid Mechanosynthesis

## Background

One proposed pathway to atomically precise manufacturing is scanning probe diamondoid mechanosynthesis (DMS): employing scanning probe technology for positional control in combination with novel reactive tips to fabricate atomically-precise diamondoid components under positional control. This pathway has its roots in the 1986 book *Engines of Creation*, in which the manufacture of diamondoid parts was proposed as a long-term objective by Drexler [1], and in the 1989 demonstration by Donald Eigler at IBM that individual atoms could be manipulated by a scanning tunneling microscope [2]. The proposed DMS-based pathway would skip the intermediate enabling technologies proposed by Drexler [1a, 1b, 1c] (these begin with polymeric structures and solution-phase synthesis) and would instead move toward advanced DMS in a more direct way.

Although DMS has not yet been realized experimentally, there is a strong base of experimental results and theory that indicate it can be achieved in the near term.

- Scanning probe positional assembly with single atoms has been successfully demonstrated in by different research groups for Fe and CO on Ag, Si on Si, and H on Si and  $\text{CNHCH}_3$ .
- Theoretical treatments of tip reactions show that carbon dimers<sup>1</sup> can be transferred to diamond surfaces with high fidelity.
- A study on tip design showed that many variations on a design turn out to be suitable for accurate carbon dimer placement. Therefore, efforts can be focused on the variations of tooltips of many kinds that are easier to synthesize.

A patent on this approach has been filed by Zyvex [3], and continued advances along these lines are being pursued by Robert Freitas and Ralph Merkle in collaboration with various research groups [4]. This fabrication approach could meet the challenges defined by DARPA in its recently issued Broad Agency Announcement (BAA) soliciting proposals on Tip-Based Nanofabrication to make nanowires, nanotubes, or quantum dots using functionalized scanning probe tips [5].

## Motivation

The reason the DMS approach is such an attractive pathway to atomically precise manufacturing is that it directly achieves APM with existing positioning technology.

<sup>1</sup> Two carbon atoms covalently bound to each other.

The best scanning probe microscopes have the resolution (about 0.5 Å) but not the repeatability (0.5 Å repeatability needed, 10 Å achieved) required for the task, so the challenge is to push the frontier of existing nanomanipulator technology and combine it with advances in tip functionalization to pick and place atoms.

## Experimental Advances

The concept of mechanosynthesis, in general, finds a ready existence proof in the operation of the ribosome in biological systems. The ribosome mechanically forces the transfer of peptides from tRNA onto a growing polypeptide chain under positional control. As Kay, *et al.* point out [6], the first demonstration of artificial mechanosynthesis between molecular units was achieved by Itoh, *et al.* in 2004 when they mechanically drove an  $\text{F}_1$ -ATPase motor backwards to synthesize ATP, reversing the hydrolysis reaction [7].

Published research provides solid evidence that scanning probe microscopes can be used to add and remove individual atoms from a crystal lattice, and to chemically bind a single atom to a single molecule. The first experimental demonstration that individual atoms can be manipulated was performed by IBM scientists in 1989 when they used a scanning tunneling microscope to precisely position 35 xenon atoms on a nickel surface to spell out the corporate logo “IBM” [2]. However, this feat did not involve the formation of covalent chemical bonds. In 1999 Ho and Lee showed that a scanning tunneling microscope could pick up a single molecule (carbon monoxide) and chemically bind it to a single atom (iron) sitting on a silver crystal surface [8]. An applied voltage facilitated the chemical reaction.

In 1998 Lyding's group showed that hydrogen could be removed from single atomic sites on a silicon surface using a scanning tunneling microscope [9]. This technique was then adapted to selectively add organic molecules to the vacant sites in a process called Feedback Controlled Lithography [10-12]. Additional examples of hydrogen abstraction are provided in [13].

The first experimental demonstration of pure mechanosynthesis, establishing covalent bonds using only mechanical forces, was reported by Oyabu and colleagues [14] in the Custance group, in 2003. In this landmark experiment, the researchers vertically manipulated single silicon atoms from the  $\text{Si}(111)-(7\times 7)$  surface, using a low-temperature near-contact atomic force microscope to (1) remove a selected silicon atom from its equilibrium position without perturbing the  $(7\times 7)$  unit cell and (2) deposit a single Si atom on a created vacancy—both via purely mechanical processes.



## Theoretical Advances

Diamonoid mechanosynthesis has undergone increasingly sophisticated theoretical analysis since its first treatment in 1992 [15]. In all cases, the conclusion is that positionally controlled DMS can be achieved in a vacuum or machine-phase environment where undesirable species are not available to cause unwanted side reactions. The most recent computational modeling results of the transfer of carbon to and from various tip designs show that:

- The barrier to dimer transfer to bare diamond, at least for some tooltip/surface combinations, is predicted to be zero [16].
- The maximum temperature at which a tip can reliably position a carbon dimer depends on the tip design, and ranges from 80K to 300K [17, 18].
- A study on variations in tip design showed that 24 out of 53 candidate designs turned out to be suitable for accurate carbon dimer placement [19]. Therefore, initial experimental efforts can be focused on the variations that are easier to chemically synthesize.
- The positional accuracy needed for DMS is about 0.05 nm, similar to the resolution limit in one or more degrees of freedom of several scanning probe microscopes and nanomanipulators [20].
- For a germanium-based tool, if a second C<sub>2</sub> dimer is placed next to an isolated dimer that was previously placed on a flat diamond surface, there is a significant chance of defect formation (the atoms will move out of position). However, placing the dimers in alternating rows and then filling in the gaps in subsequent operations allows the atoms to retain their positions with high fidelity, even at room temperature [18].

A recent three-year study concluded that DMS can be used to build single crystal diamond, carbon nanotubes, and at least nine different DMS tool tips [21]. The theoretical analysis was rather involved, as it had to define 65 DMS reaction sequences incorporating 328 reaction steps, and account for 354 pathological side reactions to be avoided. These mechanosynthetic reaction sequences range in length from 1-13 reaction steps (typically 4) with 0-10 possible pathological side reactions or rearrangements (typically 3) reported per reaction. A Density Functional Theory (DFT)-based package (Gaussian 98) was used to perform the analysis, resulting in 1,321 unique quantum chemistry reaction energies reported.

Significant theoretical work has been conducted also on hydrogen abstraction [22] and hydrogen donation [23],

which has since been validated by experimental successes such as those reported above and in these references.

## Pathway Challenges and Milestones

Critical advances are required to verify the simulation results which show that DMS can be accomplished by positional control of a scanning probe tip. We have identified the following key near-term experimental objectives that appear worthy of immediate pursuit:

1. Design and fabrication of a scanning probe tip that can be functionalized to hold a hydrocarbon molecule and retain the carbon atoms in that molecule while the hydrogen atoms are stripped or abstracted.
2. A demonstration that carbon atoms can be added to (and abstracted from) a diamond surface via positional control of a scanning probe tip. This would be a proof-of-concept demonstration: the transfer operation would not necessarily have high reliability, and the control would not necessarily be advanced enough to pinpoint a specific atomic site.
3. Development of a low-noise SPM positioning system with highly repeatable sub-Angstrom (0.2-0.5 Å) positioning accuracy over 1-micron round-trip paths, coupled with a sub-nanometer precision coordinate system spanning at least tens of microns.
4. Development of a manipulator with rotational degrees of freedom for single molecule positioning (e.g., having workpiece rotation and tilt available during manipulation events) in early systems, and possibly to include, in later systems, the closed-loop control of a dual tip AFM system with at least 5 degrees of freedom per tooltip (6 DOF per tip would be better to ensure that we can accurately align the tooltips).
5. Methods to characterize/validate tooltips and product structures once they have been fabricated, without destroying or inactivating them—especially important in the early stages of DMS experimentation when our experience with (and understanding of) these systems is at its lowest ebb.

## Milestones

In addition to the critical advances above, the following milestones would each be a significant advance in atomically precise manufacturing technology based on scanning probe DMS:

1. Extension of the above capabilities to multiple-tip nanopositioning systems.



2. Developing computer control of tip trajectories, rotations, and positioning, with the ultimate objective of fully automating the DMS process so that nanostructures may be fabricated according to a particular blueprint without direct intervention of a human operator for each reaction.
3. Experimental demonstration of purely mechanosynthetic (i.e., mechanical forces only, no electric fields involved) H abstraction, preferably on a diamond surface.
4. Experimental demonstration of purely mechanosynthetic H donation, preferably on a diamond surface.
5. Experimental demonstration of a purely mechanosynthetic sequence of two or more DMS reactions on or near the same reactive site on the same workpiece — for example, two adjacent H abstractions on a diamond surface, or a C<sub>2</sub> dimer placement on C(110) followed by H donation onto the previously-placed C<sub>2</sub> dimer
6. Experimental demonstration of the ability to perform a repeatable sequence of DMS operations on a diamond surface, resulting in the verifiable fabrication of a new diamondoid structure on that surface
7. Experimental demonstration of a purely mechanosynthetic fabrication of a significant 3D diamondoid nanostructure.

## Conclusions

The general concept of mechanosynthesis is not only feasible, but well-proven and ubiquitous in biological systems. Scanning probe positionally-controlled chemical reactions between single atoms and molecules has been clearly demonstrated in careful experiments under high vacuum and low temperature conditions. Theoretical analyses and simulations with high quality DFT-based models of the scanning probe *diamondoid* mechanosynthesis operation shows that diamondoid structures can be fabricated with this technology. To date, there has been no experimental verification of this conclusion (with no failed attempts reported, either). Improvements in both tip technology and positional control technology will likely advance this pathway, spurred in part by the recent DARPA BAA soliciting proposals on Tip-Based Nanofabrication to make nanowires, nanotubes, or quantum dots.

## References

- [1] Drexler, K.E., *Engines of Creation*, Doubleday, New York (1986).

- [1a] K. Eric Drexler, "Molecular Engineering: An Approach to the Development of General Capabilities for Molecular Manipulation," *Proc. Natl. Acad. Sci. USA*, 78(September 1981):5275-5278.
- [1b] K. Eric Drexler, *Nanosystems: Molecular Machinery, Manufacturing, and Computation*, John Wiley & Sons, New York, 1992.
- [1c] K. Eric Drexler, "Toward Integrated Nanosystems: Fundamental Issues in Design and Modeling," *Journal of Computational and Theoretical Nanoscience*, Volume 3, Number 1, February 2006, pp. 1-10(10)
- [2] Eigler, D.M. and E.K. Schweizer, "Positioning Single Atoms with a Scanning Tunneling Microscope," *Nature* **344** (5 April 1990): 524-526.
- [3] R.A. Freitas Jr., "A Simple Tool for Positional Diamond Mechanosynthesis, and its Method of Manufacture," U.S. Provisional Patent Application No. 60/543,802, filed 11 February 2004; U.S. Patent Pending, 11 February 2005; <http://www.MolecularAssembler.com/Papers/DMSToolbuildProvPat.htm>
- [4] "Past and Present Participants in the Nanofactory Collaboration (2000-present)," Nanofactory Collaboration website, accessed July 2007; <http://www.MolecularAssembler.com/Nanofactory/Collab.htm>
- [5] Thomas Kenny, "Tip-Based Nanofabrication (TBN)," DARPA BAA 07-59, July 2007; <http://www.fbo.gov/spg/ODA/DARPA/CMO/BAA07-59/listing.html>
- [6] E. R. Kay, D. A. Leigh, F. Zerbetto, "Synthetic Molecular Motors and Mechanical Machines," *Angew. Chem. Int. Ed.* **46** (2007): 157.
- [7] H. Itoh, A. Takahashi, K. Adachi, H. Noji, R. Yasuda, M. Yoshida, K. Kinoshita, "Mechanically driven ATP synthesis by F<sub>1</sub>-ATPase," *Nature* **427** (2004): 465-468.
- [8] H.J. Lee, W. Ho, "Single Bond Formation and Characterization with a Scanning Tunneling Microscope," *Science* **286**(1999):1719-1722; <http://www.physics.uci.edu/%7Ewilsonho/stm-lets.html>
- [9] Foley, E. T., Kam, A. F., Lyding, J. W., and Avouris, P. H., "Cryogenic UHV-STM Study of Hydrogen and Deuterium Desorption from Si(100)," *Physical Review Letters*, **80**/6 (1998): 1336-1339.
- [10] M. C. Hersam, G. C. Abeln, and J. W. Lyding, "An approach for efficiently locating and electrically contacting nanostructures fabricated via UHV-STM lithography on Si(100)," *Microelectronic Engineering*, **47**, 235 (1999).

- [11] M. C. Hersam, N. P. Guisinger, and J. W. Lyding, "Silicon-based Molecular Nanotechnology," *Nanotechnology* **11**, 70 (2000). <http://www.MolecularAssembler.com/Papers/PathDiamondMolMfg.htm>
- [12] N. P. Guisinger, S. P. Elder, N. L. Yoder, and M. C. Hersam, "Ultra-high vacuum scanning tunneling microscopy investigation of free radical adsorption to the Si(111)-7x7 surface," *Nanotechnology*, **18**, 044011 (2007).
- [13] R. Freitas and R. Merkle, "Annotated Bibliography on Diamond Mechanosynthesis," (2007). <http://www.molecularassembler.com/Nanofactory/AnnBibDMS.htm>
- [14] N. Oyabu, O. Custance, I. Yi, Y. Sugawara, S. Morita, "Mechanical vertical manipulation of selected single atoms by soft nanoindentation using near contact atomic force microscopy," *Phys. Rev. Lett.* **90** (2 May 2003):176102; <http://link.aps.org/abstract/PRL/v90/e176102>
- [15] K. Eric Drexler, *Nanosystems: Molecular Machinery, Manufacturing, and Computation*, John Wiley & Sons, New York, 1992.
- [16] David J. Mann, Jingping Peng, Robert A. Freitas Jr., Ralph C. Merkle, "Theoretical analysis of diamond mechanosynthesis. Part II. C<sub>2</sub> mediated growth of diamond C(110) surface via Si/Ge-triadamantane dimer placement tools," *J. Comput. Theor. Nanosci.* **1** (March 2004):71-80.
- [17] Damian G. Allis, K. Eric Drexler, "Design and Analysis of a Molecular Tool for Carbon Transfer in Mechanosynthesis," *J. Comput. Theor. Nanosci.* **2** (March 2005): 45-55. <http://e-drexler.com/d/05/00/DC10C-mechanosynthesis.pdf>
- [18] J. Peng, R.A. Freitas Jr., R.C. Merkle, J.R. Von Ehr, J.N. Randall, G.D. Skidmore, "Theoretical Analysis of Diamond Mechanosynthesis. Part III. Positional C<sub>2</sub> Deposition on Diamond C(110) Surface using Si/Ge/Sn-based Dimer Placement Tools," *J. Comput. Theor. Nanosci.* **3** (February 2006):28-41; <http://www.MolecularAssembler.com/Papers/JCTNPe ngFeb06.pdf>
- [19] Robert A. Freitas Jr., Damian G. Allis, Ralph C. Merkle, "Horizontal Ge-Substituted Polymantane-Based C<sub>2</sub> Dimer Placement Tooltip Motifs for Diamond Mechanosynthesis," *J. Comput. Theor. Nanosci.* **4** (May 2007): 433-442. <http://www.MolecularAssembler.com/Papers/DPTMotifs.pdf>
- [20] R. A. Freitas, "Pathway to Diamond-Based Molecular Manufacturing," invited talk at First Foresight Conference on Advanced Nanotechnology, Crystal City, VA (24 October 2004).
- [21] Robert A. Freitas Jr., Ralph C. Merkle, "A Minimal Toolset for Positional Diamond Mechanosynthesis," *J. Comput. Theor. Nanosci.* **4** (2007). In press.
- [22] Berhane Temelso, C. David Sherrill, Ralph C. Merkle, Robert A. Freitas Jr., "High-level Ab Initio Studies of Hydrogen Abstraction from Prototype Hydrocarbon Systems," *J. Phys. Chem. A* **110**(28 September 2006):11160-11173. <http://www.MolecularAssembler.com/Papers/TemelsoHAbst.pdf>
- [23] Berhane Temelso, C. David Sherrill, Ralph C. Merkle, Robert A. Freitas Jr., "Ab Initio Thermochemistry of the Hydrogenation of Hydrocarbon Radicals Using Silicon, Germanium, Tin and Lead Substituted Methane and Isobutane," *J. Phys. Chem. A* **111**(15 August 2007):8677-8688. <http://www.MolecularAssembler.com/Papers/TemelsoHDon.pdf>

## Limitations of Bottom-Up Assembly

Much of the beauty and complexity in chemical synthesis is the combinations of chemical reactions that add molecules and later remove part (or all) of what was added as the complex molecule is built up.

When diffusion is the method of delivering the atom or molecule, there are two problems and one large advantage. The advantage is that diffusion is a massively parallel process with little or no cost. The disadvantages are the stochastic nature of the process and the lack of spatial control. The stochastic nature of the self-assembly leads to yields of less than 100% on any one step. When the synthesis involves many steps the problem is compounded. For example the ability to synthesize designed sequences of DNA is of huge value, but these synthesized DNA strands are limited to a modest number of base pairs, because of this very problem.

The lack of spatial control creates problems when multiple identical binding sites exist that need different components added to them. It is difficult if not impossible to address these identical binding sites when using diffusion as the delivery mechanisms.

There are techniques, recently developed, that use designed binding sites at specific spatial locations to create more complex structures. In particular, specific DNA sequences can be used for very selective binding and arbitrary 2D structures have been designed and fabricated with some early attempts at generating 3D structures. See the section on DNA construction elsewhere in the roadmap.

However, it has been postulated that there is a trade-off between the complexity of the end product and the robustness of the self assembly process and/or product]. Using the DNA construction technique mentioned above, one can see some of the trade-offs. DNA is presently unique in being able to form million-atom scale, atomically precise, 3D structure, with addressable locations throughout. However, the primary strand of DNA that is used for this construction cannot be fabricated with current synthesis techniques because it is too long (too complex). The long DNA strand has to be borrowed from a natural source with a well known sequence. The much shorter DNA strands that are used to link to the primary DNA strand are designed and synthesized to create the structure. While it is clear that this construction technique can be improved on, DNA itself is a problem. It is only one material (and not a very robust one at that) lacking the tremendous number of properties that you'd like to have for a wide range of purposes.

While this general approach of many weak complementary bonds to form a selective binding site may well be extended to other materials, this binding will always rely on weak bonding where individual bonds are easily broken so that the bonding surfaces may be move with

respect to each other until the ideal complementary alignment is found. This basic approach will typically result in materials that are not terribly robust.

Looking beyond DNA type self assembly construction, there are a number of examples of self-assembly processes that work well for simple structures, producing durable end results, but the fragility of the process and the end product are increased as the complexity of the structure increases. Using crystal growth as one model of self-assembly, we can see this trade-off. Simple crystals such as Si can be grown with a straight forward and robust process that produces large, high purity, nearly perfect crystals. Complex crystals such as protein crystals are notoriously difficult to grow and the resultant crystals are extremely fragile. These and other examples suggest that self assembly has limitations that will preclude it being the sole path to creating large, complex, and robust structures.

While a bottom-up self-assembly path to APM is certainly worth pursuing because of its economy due to the massively parallel nature, the limitations listed above are reason enough to consider alternative pathways that may circumvent some of these limitations.



## Nucleic Acid Engineering

### Summary

Structural DNA nanotechnology provides the ability to construct molecularly precise structures based upon the well-understood molecular recognition properties of DNA. Numerous molecularly precise DNA nanostructures have been demonstrated. Some are capable of controlled movements, using multiple mechanisms to generate motion. DNA nanostructures can be constructed to incorporate a wide range of chemical functions. Micron-scale and larger 2-dimensional periodic arrays of DNA nanostructures have been built. At the scale of 100 to several hundred nanometers, DNA nanostructures can be arranged in an arbitrary aperiodic pattern in two dimensions, and there is reasonable hope that this ability can soon be extended to three dimensions. Molecular biology and the biotechnology industry provide a well developed infrastructure for the technology: a wide range of DNA molecules, reagents, and methods useful for creating and characterizing DNA nanostructures. The most recently developed and perhaps the most promising approach to structural DNA nanotechnology—scaffolded DNA origami—enables quick and inexpensive implementation with ~5 nm resolution and lends itself to automated design and manufacture.

Biology is based upon evolved nanometer-scale systems in which molecular recognition is used to organize systems of molecular devices that together are capable of complex atomically precise fabrication. As a step to develop artificial systems for atomically precise fabrication, researchers have looked to biokleptic molecules to construct, organize, and control molecular machines in three dimensions or on a surface.

The most promising results so far toward designing and building such systems have been obtained with DNA. Linear duplex DNA is, however, of limited use. Although, the base pairing between the two complementary strands of DNA in the helix has been used as ‘smart glue’ to assemble molecules or nanoparticles into clusters of known composition that have useful properties and functions, it can not be used without modification to build nanostructures with predictable geometry. The key innovation that enabled structural DNA nanotechnology was the design and implementation of stable branched structures of DNA that could be combined to form larger covalent and non-covalent structures, of diverse three dimensional geometry and with nanomechanical functionality, using base-pairing between overhanging single strand ends of DNA. The advent of structural DNA nanotechnology was reviewed in 2003 by its inventor, Nadrian C. Seeman (Ref. 1).

### Programmable Molecular Interactions

The key property of biological nanostructures is molecular recognition, and DNA provides the molecular recognition properties most conveniently exploited for designing nanostructures. On the partner strands of the DNA double helix, the base A always pairs with the base T and G always pairs with C—termed Watson-Crick base pairing. Joining the ends of two DNA double helices is facilitated by overhanging single strands, called ‘sticky ends’, that extend one strand beyond the end of the double helix. Complementary sticky ends will bind to form a double helix, which has a known geometry—the familiar B form of DNA. Thus the needed sequence of the complementary strand is immediately known and the geometry of the bound species—the DNA double helix—is immediately known. Furthermore, DNA base-pairing allows a large number of specific interactions to be scripted— $4^N$  sequences for a sticky end N nucleotides long. To join two double helices end-to-end, an enzyme called ligase will form covalent bonds between the two helices held together by sticky ends. Nucleic acids are unique among available molecules in providing a large repertoire of programmable intermolecular interactions that all form atomically precise products of known structure.

### Stable Branched Structures

Branched structures—called Holliday junctions—occur transiently in natural DNA during the process of genetic recombination, in which homologous chromosomes exchange information through the formation of a mobile junction of four strands of DNA. The resulting 4-arm junction is ephemeral because the homology of the two DNA helices permits the branch point to move freely up and down the DNA. However, sets of DNA sequences can be designed lacking the sequence symmetry necessary for branch migration. In this way, stable branched junctions having three to twelve arms have been assembled and characterized.

Additional benefits of building with DNA include (i) the existence of a well-developed infrastructure of reagents and technologies provided by the biotechnology industry—especially the automated synthesis of single-strand DNA oligonucleotides of more than 100 nucleotides, (ii) the fact that the base sequence of a DNA can be read even when the double helix is intact by ‘reading’ the grooves along the outside of the helix, enabling in theory the determination of absolute position along the DNA helix, and (iii) a variety of synthetic molecules are available as alternative bases and alternative backbone structures that may be chemically more useful for certain functions.



Stable branched junctions were used to build covalently closed branched DNA molecules. Those constructed include one in which the DNA helix axis forms the edges of a cube, and another the edges of a truncated octahedron. Although these initial constructions demonstrated designed topological connectivities, they were too floppy to form a scaffold for positioning molecules in space. Although the double helices flanking the branch points are rather stiff, the angles formed at the branch points are floppy. These floppy branched junctions are thus unsuitable for constructing larger, well-structured DNA systems.

## Stiff Building Blocks

The problem of too little angular rigidity in branched DNA junctions was solved by using double-crossover (DX) molecules, in which two 4-arm branched junctions are joined at two adjacent double helical arms. The result is two side-by-side double-stranded helices linked by two crossovers. Five different double-crossover molecules can be constructed, depending on whether the strands forming the crossover are of the same or opposite polarities, and whether there are an even or an odd number of helix half-turns between crossovers (in the case of parallel helices with an odd number of half turns, there are two options depending on whether the extra half turn corresponds to the major or minor groove of the DNA double helix). Of these, the parallel cases do not appear to be stable in small molecules, leaving the two antiparallel cases (designated DAE and DAO) for nanoconstruction.

It is possible to incorporate a third junction that forms a DNA hairpin roughly perpendicular to the plane of the other two helices. This extra structural domain provides a topographic marker that can be detected by atomic force microscopy (AFM), facilitating direct imaging of critical features of arrays incorporating these molecules.

DX molecules are rigid enough to tile a surface by self-assembling to form two-dimensional DNA crystals (Ref. 2). Each double crossover molecule was designed with a unique sticky end at each corner to program association to form blocks from either two or four individual double crossover molecules; that is, periodic blocks composed of either two or four tiles. Self-assembly of these blocks into two dimensional lattices occurred via the sticky ends remaining at the corners of these blocks. Incorporation of a third junction in one of the DX molecules in some cases resulted in stripes readily apparent by AFM. The DX molecules used formed tiles 2 nm thick, 4 nm wide, and either 13 or 16 nm long. The single domain crystals formed from these tiles were as large as 2 by 8 microns. The versatile chemistry of oligonucleotide synthesis should allow decorating any point of selected tiles with additional chemical groups, catalysts, proteins, etc. to provide functions at lattice points defined by the tile arrangement.

## Controlling Mechanical Movement of Building Blocks

Rigid nanostructures make possible nanomechanical devices because a rigid object can respond to an external signal by moving in a predictable fashion, and this behavior can be observed reliably in an ensemble of molecules. Multiple crossover motifs were first used to demonstrate a DNA nanomechanical device based on the transition of the normal, right-handed B form of the DNA helix to the left-handed helix of Z-DNA (Ref. 3). Two DAO motifs, each with three helix half-turns between the two crossover points, were separated by one double helix of 9 half-turns. The ends of all helices were closed with hairpin loops. The double helix connecting the two DAO units contains a sequence that changes its structure from B- to Z-DNA in altered chemical environments. This change is expected to result in a rotation of the two ends of the structure with respect to each other, and an increase in the length of the center portion of the structure. Resonance energy transfer between two fluorescent dyes attached to the hairpin loops on the inner ends of each DAO motif decreased with the B to Z transition in the center of the structure, indicating an increase in the distance between the two dye molecules of 2.0 nm.

A limitation of the B to Z DNA nanomechanical switch is the dependence on a single signal to stimulate a change in the state of a switch so that an array of switches could not be individually addressed. A molecular tweezers powered by the formation of double helical DNA introduced the use of specific DNA sequences as both signal and fuel for DNA nanomechanical devices so that multiple switches could potentially be individually addressed (Ref. 4). The tweezers is made of three single strands of DNA: a central A strand which connects the B and C strands that form each pincer. Two additional fuel strands, F and F' are used to close and open the tweezers. Strand A consists of two 18-base domains, each of which is the complement of a sequence at one end of strand B or C, separated by a 4-base hinge. Each arm of the tweezers is therefore a stiff 18-base pair double helix while the hinge is a short, flexible single strand (the persistence length of the DNA double helix is about 50 nm—about 150 base pairs—while the persistence length of single strand DNA is about 1 nm—about 3 bases). This simple nanodevice is implicitly branched. The ends of strands B and C opposite the hinge each consist of a 24-base single strand extension. The 56-base closing fuel strand F consists of the complements of the 24-base dangling ends of B and C plus an 8-base extension. Adding strand F forces the ends of the pincers (the opposite ends of strand A) together as the dangling ends of B and C are incorporated into a double helix with F. The 56-base opening fuel strand F' is a complete complement of strand F so adding F' outcompetes the formation of a double helix of F with B and C.

F is removed from the tweezers, the pincers opens, and a 'waste' double helix FF' is generated.

Fluorescence quenching of two dyes that label the ends of strand A measures the separation of the ends of the pincers, documenting successive cycles of opening and closing the tweezers upon successive additions of strands F and F'. Seven open-close cycles were demonstrated with a switching time of about 13 seconds. The separation between the ends of the tweezers changes by 6 nm between the open and closed states. This device had some problems with dimerization upon switching states.

This same principle of fueling and controlling nanomechanical motion by the reversible binding of DNA strands to cause conformational change was used to create rotary motion via a four-step cycle that interconverts two robust crossover motifs (the 252-nucleotide topological isomers PX and JX<sub>2</sub>) in which one strand end is rotated relative to the other by 180 degrees (Ref. 5). PX is a paranemic crossover molecule in which two parallel double helices are joined by a crossover (reciprocal strand exchange) at every point where the strands come together. JX<sub>2</sub> is a topological isomer of PX that contains two adjacent sites where the double helices juxtapose but do not exchange strands. As a consequence, the top ends of both isomers are identical, but the bottom ends are rotated 180 degrees with respect to each other. PX and JX<sub>2</sub> are each constructed of four DNA strands, two of which are common to both isomers. The other two strands of each are the two 'set' strands unique to each isomer. The PX set strands implement the two crossovers in the central portion of PX. The JX<sub>2</sub> set strands form no crossovers in the central portion of JX<sub>2</sub>. Each set strand has an extension at either one end or the other that remains single strand so that only part of the strand is paired in the crossover motif. For each set strand, there is a fuel strand that is complementary to the entire sequence of the set strand. In the first step of the cycle, the two PX-specific fuel strands are added and bind the single strand extensions of the two PX set strands. Branch migration favors binding the entire set strand, removing the two set strands from the PX motif, leaving an unstructured intermediate. In the second step, the two JX<sub>2</sub>-specific set strands are added, converting the unstructured intermediate to the JX<sub>2</sub> motif. Addition of JX<sub>2</sub>-specific fuel strands in the third step converts the JX<sub>2</sub> motif to the unstructured intermediate. Completion of the cycle with the addition of the PX-specific set strands restores the PX motif.

The intended change in molecular conformation (a rotation of 180 degrees) was demonstrated using atomic force microscopy of individual molecular devices. For this purpose, a linear array was constructed in which PX-JX<sub>2</sub> devices alternate with half-hexagon markers, each constructed from three DNA triangle tiles. Each half-hexagon marker is comprised of nearly 250 nucleotides so that each marker is comparable in mass to one of the

mechanical devices. When the three devices are in the PX configuration, the four markers are all aligned along one side of the complex (*cis* arrangement); when the devices are in the JX<sub>2</sub> configuration, the markers form a zig-zag pattern with alternate markers on opposite sides of the complex (*trans* arrangement). AFM images show that individual molecular complexes are in either the *cis* or *trans* arrangement, as expected according to whether DNA strands are added to convert the devices to the PX or to the JX<sub>2</sub> motifs. The array of markers and devices appears to be about 200 nm in length, and the further points of the half-hexagon markers are rotated a distance of about 35 nm.

In describing this research Seeman said: "If we can incorporate N different species of these two state devices in 2D or in 3D, we should be able to generate 2<sup>N</sup> different structural states. Short-range goals include creating a molecular pegboard and, possibly, using species derived from this system for producing a molecular assembly line. Multiple structural states are a necessary concomitant of nanorobotics, so this system seems capable of leading to DNA-based nanorobotics." (Ref. 1)

The basic principle of binding single strands of DNA to DNA nanodevices to control and fuel nanomechanical motion is generally useful and has been used in other ways in addition to accomplishing rotary motion. Precisely controlled DNA biped walking devices were constructed that move forward or backward along a constructed footpath to desired destinations (Ref. 6, 7). Potentially, multiple bipeds could be independently directed along 2- or 3-dimensional footpaths. This and other applications of motion in an array of defined positions are considered in the accompanying report "DNA as an Aid to Self-Assembly".

Another case of control of motion through reversible binding of strands takes advantage of the 4-way non-Watson-Crick interaction among four G nucleotides that stabilizes the ends of eukaryotic chromosomes. Two different research groups constructed very similar single DNA molecule nanomotors that execute an inchworm-like extending-shrinking motion by switching between the G tetraplex structure and the standard DNA duplex upon binding with added DNA strands (Ref. 8, 9). Other implementations of nanomechanical devices are included in recent reviews (10, 11). One example involves the i-motif, a compact tetraplex structure formed by protonation of cytosine bases in certain C-rich strands. Converting the i-motif to a double helix has been demonstrated to do mechanical work.

## Building Blocks That Can Grab

This same transition between G tetraplex and duplex DNA structures was combined with another very useful property of DNA—short stretches of single strand DNA called aptamers can be selected from a random pool of

sequences by successive cycles of variation and amplification to bind to specific proteins or small molecules—to construct a molecular machine that can be instructed to grab or release a specific protein depending on an operator DNA sequence used to address the nanomachine (Ref. 12). An aptamer was selected, a 15-base single strand, that strongly bound the protein and assumed a conformation that contained a tetraplex structure. One end of this aptamer was elongated with 12 additional bases that did not affect the binding to the protein or the tetraplex conformation, but which provided a target sequence to use to control the DNA hand. To open the hand, a single strand sequence was added to form duplex DNA with the target sequence plus part of the 15-base aptamer. Driven by the favorable energy of forming the duplex, the aptamer abandoned the conformation containing the tetraplex, releasing the protein. The opening sequence also contained additional bases not involved in binding to the 27-base hand. To close the hand a single strand complementary to the entire opening sequence was added, pulling the opening sequence off the hand and permitting the 27-base hand to again form the tetraplex and close on the protein. Because aptamers can be selected to bind to a large variety of arbitrarily chosen compounds, it should be possible to construct DNA-based nanomachines useful for carrying, binding, and releasing other molecules as well.

## Many Shapes and Structures for Building Blocks

DNA multiple crossover motifs do not exhaust the possible useful building block structures that can be formed from DNA. For example, by using two DNA helices rather than one for each arm of a 4-arm motif, square tiles have been constructed from four four-arm junctions and designed to assemble into square lattices, named the 4 x 4 motif, containing square centers with center-to-center distances of about 19 nm. Because each square cavity is surrounded by part of 4 tiles, there is the potential to combinatorially define cavities for constructing patterns with addressable features (Ref. 13). Fully addressable DNA tile lattices of controlled size have been formed from cross-shaped tiles by hierarchical assembly procedures (Ref. 14). A loop of single strand DNA at the center of each tile allows the optional additional of a protein molecule that can be imaged with an atomic force microscope to turn the tile into a pixel. This option was used with 4 x 4 arrays of tiles to demonstrate that each tile in the array is individually addressable. The researchers used protein decoration of three such arrays to spell “DNA” in 80-nm square letters.

In an innovative approach to avoid the low yields and labor-intensive procedures of the current methods of constructing molecular building blocks from branched DNA junctions, DNA tetrahedra were designed to quickly and easily self-assemble from 4 oligonucleotides (short single

strand DNA segments)(Ref. 15). Each of the 4 oligonucleotides runs around one of the four faces. The six edges each comprise a double helix made by hybridization of matching sequences, and a single unpaired nucleotide hinge allows strands to bend at each vertex. Four edges contain a single strand nick where the two ends of an oligonucleotide meet. Regular tetrahedra with edges of 20 base pairs and various irregular tetrahedra were constructed. The nicks could be ligated or used to accommodate single strand overhangs for the purpose of linking tetrahedra together via sticky ends to form larger 3-D nanostructures. Alternatively, a 30-base pair edge is long enough to accommodate a 10-base pair single strand gap in an edge for the purpose of binding a strand for programmable linking of tetrahedra. To date, however, these mechanically robust and chirally uniform building blocks have not been incorporated into larger nanostructures.

A number of tiles of branched DNA motif building blocks, with diverse shapes and structures, have been described and have been recently reviewed (Ref. 16). The reviewers note that the “molecular-level control demonstrated by these systems represents a major step toward developing DNA-based controllable nanostructure” but “important limitations exist... in order to achieve high assembly yields.”

## Programming Assembly with a Scaffold Strand

The goal of programmed self-assembly of aperiodic nanostructures from DNA molecules has been substantially advanced by “scaffolded assembly” or “nucleated assembly”, in which assembly is directed by a long single strand DNA scaffold. Other work with programmed self-assembly of DNA tiles provided either small assemblies or large lattices with simple periodic patterns. The information to specify a more complex pattern of tiles can be encoded in a long DNA strand about which the DNA tiles self-assemble. An initial demonstration assembled double crossover DNA tiles around a scaffold strand to form a barcode lattice with an aperiodic pattern encoding five bits of information (Ref. 16).

In addition to constructing 2-dimensional lattices, scaffolded assembly has also been used to create a 3-dimensional object: an octahedron formed by the programmed folding of a 1,669-nucleotide DNA strand in the presence of five 40-mer DNA strands (Ref. 18). The products are hollow octahedra about 22 nm in diameter, with each of the 12 edges consisting of either a double-crossover or a paranemic-crossover, and each potentially uniquely addressable by an appropriate DNA sequence. This approach of designing a large single strand DNA molecule to fold into a desired shape has been referred to as ‘DNA origami’.



The usefulness of DNA origami was substantially extended by Paul Rothemund of Caltech who developed a simple, inexpensive way to obtain a wide variety of two-dimensional DNA nanostructures, in high yields (Ref. 18). Typically these DNA nanostructures are about 100 nm in diameter and 2 nm thick (the diameter of the DNA double helix). Based on the size and packing of the short DNA double helical segments used to form these structures, the resolution at which features can be designed is about 6 nm. Thus these DNA nanostructures can be viewed as about 200 pixels arranged in whatever pattern of surface shapes and holes is desired. Among the stunning atomic force microscope (AFM) images presented to document the nanostructures created are a “smiley face” and a low resolution map of the western hemisphere.

The process termed ‘scaffolded DNA origami’ uses a set of small single-stranded DNA molecules to guide the folding of a long single-stranded DNA molecule in a simple ‘one-pot’ method that can be used to form arbitrary two-dimensional shapes. Each nanostructure presented was formed by mixing the same scaffold of about 7000 nucleotides with about 250 different 30-nucleotide-long DNA molecules, termed ‘staple strands’, specifically chosen to make the scaffold fold into the desired shape.

The first step in designing scaffolded DNA origami is to outline the desired shape, and fill it with an even number of cylinders representing short segments of double helical DNA. To hold the helices together, an array of points is designated where a DNA strand would switch from one short helix to the adjacent one. The scaffold strand is then conceptualized as folding in a raster pattern to fill the outline such that it comprises one of the two strands in each helix. There are necessary constraints on the folding based on the geometry of double stranded DNA. The folding path and the sequence of the scaffold strand are entered into a computer program that then designs the set of staple strands. Strain energies are calculated. Staple sequences are optimized to minimize strain and maximize binding to the scaffold. The staple strands are synthesized and mixed with the scaffold strand, and the structures that form are then deposited on a mica surface for imaging with an AFM. For different shapes tested, the yield of well-formed structures seen with the AFM varied from about 10% to about 90%. In the case of the smiley face structures 70% were well-formed.

An important convenience of this method is that the long scaffold strand does not need to encode the information to specify the desired nanostructure. A convenient long strand of biological origin can be used, avoiding the inconvenience of synthesizing a long strand of DNA of arbitrary sequence. The information necessary for the nanostructure is encoded in the several hundred short DNA strands, which are more conveniently made. In addition, the method successfully avoids a number of other painstaking and time-consuming technical requirements of other forms of DNA

nanotechnology, facilitating fast design, fabricate, and test cycles. Further, the desired product is often obtained in high yield.

In general, these DNA nanostructures showed the target shape to within the expected 6-nm pixel resolution determined by the size of the DNA helix formed by each staple strand. Certain modifications in the raster-fill technique enable greater precision in some cases—for example, creating triangular structures with edge lengths that are precise to within one DNA base (.34 nm) rather than one DNA helix turn (3.6 nm).

The staple strands also allowed the optional decoration of each pixel with an additional structure to produce a binary pixel. A wide variety of DNA modifications are possible, but in the initial case reported, a dumbbell loop of DNA is inserted in the middle of the staple strand. Pixels formed with staple strands containing the insert show greater height above the mica surface because of the hairpin protruding above the double helix, and thus appear in the AFM as brighter than pixels without the insert in the staple strand. The map of the western hemisphere is composed of light continent pixels and dark ocean pixels. The images show occasional missing pixels, but it is not clear whether these are the results of imperfect assembly or of damage caused by AFM imaging. Specially designed staple strands could be used to join individual nanostructures into larger structures, for example, joining six triangles to form a hexagon.

Rothemund believes that scaffolded DNA origami can be extended to create larger and more complex structures, including three-dimensional structures, and as a substrate for arranging other types of molecules.

“I believe that scaffolded DNA origami can be adapted to create more complex or larger structures. For example, the design of three dimensional structures should be accessible using a straightforward adaptation of the raster fill method given here. If non-repetitive scaffolds of megabase length can be prepared, micrometre-size origami with 20,000 features may be possible. However, the requirement for unique sequence information means that the method can not be scaled up arbitrarily; whenever structures above a critical size or level of complexity are desired, it will therefore be necessary to combine scaffolded DNA origami with hierarchical self-assembly, algorithmic self-assembly, or top-down fabrication techniques.

“An obvious application of patterned DNA origami would be the creation of a ‘nanobreadboard’, to which diverse components could be added. The attachment of proteins, for example, might allow novel biological experiments aimed at modelling complex protein assemblies and examining the effects of spatial organization, whereas molecular electronic or plasmonic circuits might be created by attaching nanowires, carbon nanotubes or gold nanoparticles.”

## Building with RNA Motifs

Addressable, self-assembling molecular building blocks have also been implemented using RNA—DNA's more labile chemical cousin, which is capable, however, of forming a greater variety of structural motifs than is DNA. While designing nanostructures from DNA is largely limited to Watson-Crick base pairing (with some use of a few other structures, such as G tetraplex structures), work with RNA can make use of the wide variety of 3-D structural motifs found in natural RNA. Although Watson-Crick base pairing is, as with DNA, the primary determinant of RNA structure, RNA exhibits a rich variety of weaker interactions that also contribute to structure. Non-Watson-Crick RNA tertiary interactions have been exploited to construct 'tectoRNA' molecular units that can self-assemble to form nanostructures. Two motifs copied from the ribosome that each specify right angle corners between two RNA helices were used to design tecto-RNAs that self-assemble to form tectosquares with either 10-nm or 13-nm sides (Ref. 20). Sticky end tectoRNA tails extending from the corners of tectosquares form programmable connectors to link the tectosquares into a variety of different nanostructures. Nine tectosquare patterns were separately assembled from a total of 22 tectosquares formed by 49 tectoRNAs of different sizes and tail structures. Nevertheless, the use of tectoRNAs to build robust fully programmable nanoscale structures is at an early stage. In the researchers' evaluation, "an unanswered question is whether [a] combinatorial population of tectosquares could still assemble accurately into organized architectures." The intricately organized architectures of RNA molecules in ribosomes, elucidated to high resolution just this past decade to reveal a number of structural motifs, provide a basis for hoping that intricate and functional artificial architectures will soon be created.

Thus structural DNA nanotechnology, built upon the robust and sophisticated infrastructure of molecular biology and the biotechnology industry enables the design, construction, and characterization of a wide variety of DNA nanostructures, including nanomechanical structures. Between the tile model based on stable branch junctions and the scaffolded DNA origami method, it is now possible to construct large 2-dimensional arrays that can include active devices and other chemical functions in an arbitrary pattern. The ability to construct 3-dimensional structures has to date been demonstrated on a smaller scale, but there do not appear to be fundamental reasons why the scaffolded DNA origami method can not be extended to three dimensions.

## References

- (1) At the crossroads of chemistry, biology, and materials: Structural DNA nanotechnology. Nadrian C. Seeman. *Chemistry & Biology* **10**, 1151-1159 (2003) <http://dx.doi.org/10.1016/j.chembiol.2003.12.002>
- (2) Design and self-assembly of two-dimensional DNA crystals. Erik Winfree, Furong Liu, Lisa A. Wenzler and Nadrian C. Seeman. *Nature* **394**, 539-544 (1998) <http://dx.doi.org/10.1038/28998>
- (3) A nanomechanical device based on the B-Z transition of DNA. Chengde Mao, Weiqiong Sun, Zhiyong Shen and Nadrian C. Seeman. *Nature* **397**, 144-146 (1999) <http://dx.doi.org/10.1038/16437>
- (4) A DNA-fuelled molecular machine made of DNA. Bernard Yurke, Andrew J. Turberfield, Allen P. Mills, Jr, Friedrich C. Simmel and Jennifer L. Neumann. *Nature* **406**, 605-608 (2000) <http://dx.doi.org/10.1038/35020524>
- (5) A robust DNA mechanical device controlled by hybridization topology. Hao Yan, Xiaoping Zhang, Zhiyong Shen and Nadrian C. Seeman. *Nature* **415**, 62-65 (2002) <http://dx.doi.org/10.1038/415062a>
- (6) A precisely controlled DNA biped walking device. William B. Sherman and Nadrian C. Seeman. *Nano Letters* **4**, 1203-1207 (2004) <http://dx.doi.org/10.1021/nl049527q>
- (7) Synthetic DNA walker for molecular transport. Jong-Shik Shin and Niles A. Pierce. *Journal of the American Chemical Society* **126**, 10834-10835 (2004) <http://dx.doi.org/10.1021/ja047543j>
- (8) A single DNA molecule nanomotor. Jianwei J. Li and Weihong Tan. *Nano Letters* **2**, 315-318 (2002) <http://dx.doi.org/10.1021/nl015713+>
- (9) DNA duplex-quadruplex exchange as the basis for a nanomolecular machine. Patrizia Alberti and Jean-Louis Mergny. *Proceedings of the National Academy of Sciences* **100**, 1569-1573 (2003) <http://dx.doi.org/10.1073/pnas.0335459100>
- (10) Synthetic Molecular Motors and Mechanical Machines. Euan R. Kay, David A. Leigh, Francesco Zerbetto. *Angewandte Chemie International Edition* **46**, 72-191 (2006) <http://dx.doi.org/10.1002/anie.200504313>
- (11) DNA nanomachines. Jonathan Bath and Andrew J. Turberfield. *Nature Nanotechnology* **2**, 275-284 (2007) <http://www.nature.com/uidfinder/10.1038/nnano.2007.104>
- (12) A DNA-based machine that can cyclically bind and release thrombin. Wendy U. Dittmer, Andreas Reuter, and Friedrich C. Simmel. *Angewandte Chemie International Edition* **43**, 3550-3553 (2004) <http://dx.doi.org/10.1002/anie.200353537>
- (13) DNA-templated self-assembly of protein arrays and highly conductive nanowires. Hao Yan, Sung Ha Park, Gleb Finkelstein, John H. Reif, Thomas H. LaBean.



- Science* **301**, 1882-1884 (2003)  
<http://dx.doi.org/10.1126/science.1089389>
- (14) Finite-size, fully addressable DNA tile lattices formed by hierarchical assembly procedures. Sung Ha Park, Constantin Pistol, Sang Jung Ahn, John H. Reif, Alvin R. Lebeck, Chris Dwyer, and Thomas H. LaBean. *Angew. Chem. Int. Ed.* **45**, 735-739 (2006)  
<http://dx.doi.org/10.1002/anie.200503797>
- (15) Rapid chiral assembly of rigid DNA building blocks for molecular nanofabrication. R. P. Goodman, I. A. T. Schaap, C. F. Tardin, C. M. Erben, R. M. Berry, C. F. Schmidt, A. J. Turberfield. *Science* **310**, 1661-1665 (2005) <http://dx.doi.org/10.1126/science.1120367>
- (16) Constructing novel materials with DNA. Thom H. LaBean and Hanying Li. *Nanotoday* **2**, 26-35 (April 2007)
- (17) Directed nucleation assembly of DNA tile complexes for barcode-patterned lattices. Hao Yan, Thomas H. LaBean, Liping Feng, and John H. Reif. *Proceedings of the National Academy of Sciences* **100**, 8103-8108 (2003)  
<http://www.pnas.org/cgi/doi/10.1073/pnas.1032954100>
- (18) A 1.7-kilobase single-stranded DNA that folds into a nanoscale octahedron. William M. Shih, Joel D. Quispe & Gerald F. Joyce. *Nature* **427**, 618-621 (2004)  
<http://dx.doi.org/10.1038/nature02307>
- (19) Folding DNA to create nanoscale shapes and patterns. Paul W. K. Rothemund. *Nature* **440**, 297-302 (2006)  
<http://dx.doi.org/10.1038/nature04586>
- (20) Building programmable jigsaw puzzles with RNA. Arkadiusz Chworos, Isil Severcan, Alexey Y. Koyfman, Patrick Weinkam, Emin Oroudjev, Helen G. Hansma, Luc Jaeger. *Science* **306**, 2068-2072 (2004)  
<http://dx.doi.org/10.1126/science.1104686>



## DNA as an Aid to Self-Assembly

### Summary

The potential role of DNA in the assembly of atomically precise structures goes far beyond ‘smart glue’ to link specific nanostructures to form larger arrays. Structural DNA nanotechnology (see accompanying article “Nucleic acid engineering”) provides tiles that can be assembled in a programmed fashion to form a wide variety of nanotubes, two-dimensional arrays, and eventually three-dimensional arrays. DNA nanotubes could potentially provide scaffolding and transport of cargo for productive nanosystems. DNA nanostructures have already been used to organize arrays of guest molecules and nanostructures. DNA devices that ‘walk’ along DNA tracks, organize components for covalent bond formation, and function mechanically in a DNA array have also been demonstrated.

Biological molecular machine systems largely self-assemble based upon the molecular recognition properties of the key biopolymers—nucleic acids and proteins. These key polymers, however, do not self-assemble from their monomeric components unaided. Instead a system of molecular machines uses the information in a template molecule to determine the required order of addition of the monomers to the growing polymer molecule. In the case of DNA and RNA there is direct molecular complementarity between the template molecule (DNA) and the product molecule (another DNA strand or an RNA strand of complementary sequence). In the case of proteins, however, there is no direct molecular complementarity between the template (an RNA strand, composed of a specific sequence of four ribonucleotides) and the product (a protein, composed of a specific sequence of twenty amino acids). Instead, an elegantly complex molecular machine system—the ribosome and its associated molecules—uses a code to translate a sequence of  $3N$  ribonucleotides into a sequence of  $N$  amino acids through a process of positional synthesis in which the next amino acid to be added is determined by the code.

Despite the complexity of protein synthesis in living cells, the synthesis of proteins is basically a problem of one-dimensional positional synthesis. Proposals for productive nanosystems or molecular manufacturing envision atomically precise positional synthesis in three dimensions. One road towards such systems exploits the precise and well-understood molecular recognition code of nucleic acids to engineer novel nanostructures and devices (see accompanying article “Nucleic acid engineering”). Of particular interest are the construction of large 3-dimensional addressable molecular networks—including composite networks incorporating other molecules in addition to DNA, molecular devices capable of programmed movement along a track, and devices capable of programmed alignment of reactants for covalent bond formation.

### DNA ‘Smart Glue’ for Assembling Nanoparticle Networks of Low Spatial Resolution

DNA provides precise and well-understood molecular recognition properties because the hybridization of two strands of single strand DNA to form the DNA double helix always pairs the base A with the base T and G with C—termed Watson-Crick base pairing. Thus DNA base-pairing allows a large number of specific interactions to be scripted— $4^N$  possible sequences for a DNA strand  $N$  deoxynucleotides long. Even using short oligonucleotides a large number of specific interactions can be programmed. The simplest use of this library of precise pairings is as ‘smart glue’ to assemble networks of nanoparticles in which the connection of one nanoparticle with one or more other nanoparticles is specified. In this way materials and devices with unique and useful properties have been created.

For example, small strands of DNA have been chemically bound to gold nanoparticles to form particle aggregates of defined composition. In one case two batches of 13 nm-diameter gold nanoparticles were each covered with different 8-deoxynucleotide strands and then made to reversibly aggregate by the addition of a short DNA molecule with two sticky ends—one sticky end complementary to each 8-mer (1). Aggregates consisted of many particles because each nanoparticle was covered with many oligonucleotides. More precisely controlled pairing was demonstrated using smaller gold nanoclusters—1.4 nm in diameter (smaller than the 2.0 nm-diameter of the DNA double helix)—each coupled to one 18-nucleotide strand chemically modified to couple to the gold clusters either at the 5' end of the oligonucleotide or at the opposite (3') end (2). (The phosphodiester bonds that form the DNA backbone link the 3' carbon atom of one deoxyribose with the 5' carbon atom of the next one so that each DNA strand has both a 5' end and a 3' end.) Mixing a 37-nucleotide template strand in which two identical 18-nucleotide domains are separated by one nucleotide, with a two fold molar excess of a complementary 18-mer conjugated at the 5' end to a gold cluster produced a head-to-tail dimer with one gold cluster near the middle of the duplex DNA and the other at one end of the duplex. Mixing a similar template containing two different 18-nucleotide domains with one complementary 18-mer conjugated to a gold cluster at its 5' end and the other complementary 18-mer conjugated at its 3' end produced a head-to-head dimer in which both gold clusters were near the middle of the duplex. Mixing the 5' end-conjugated 18-mer with a 56-nucleotide template strand containing three identical 18-nucleotide domains produce a duplex with three equally spaced gold clusters. The

aggregates produced are thus discrete, homogenous, and molecularly defined.

Molecules or nanoparticles can be linked to specific sequences on longer (for example, 16  $\mu\text{m}$ ) DNA molecules by adapting the biological process of homologous recombination, in which a protein mediates strand exchange between two DNA molecules that have some sequence homology (3). RecA, the major protein responsible for homologous recombination in the bacterium *E. coli*, coats a single strand DNA probe to form a nucleoprotein filament that, when mixed with a double strand substrate DNA molecule, binds to a region of the substrate DNA that is homologous to the probe sequence to form a complex containing both DNA molecules and many RecA protein molecules (and anything attached to the RecA).

However the above networks and junctions are all examples of low resolution nanosystems even when the composition of the networks is controlled to molecular precision because the three-dimensional geometry of the associations among nanoparticles and molecules is not well controlled. Key to using the simple molecular recognition code of DNA base-pairing to construct three-dimensional addressable molecular networks has been the development of methods that are not limited to natural linear DNA, but instead use artificial stably branched molecules of DNA, especially multiply branched molecules, to form junctions of specified geometry (see accompanying article “Nucleic acid engineering”).

## Building Frameworks of High Spatial Resolution from DNA Tiles

The capacity to construct three-dimensional addressable molecular networks began with the demonstration that small DNA tiles (for example, 2 x 4 x 16 nm) can be constructed from branched DNA molecules that are rigid enough to form crystalline arrays several  $\mu\text{m}$  in extent (4). These tiles were built from double-crossover (DX) molecules of DNA, in which two 4-arm branched junctions are joined at two adjacent double helical arms. The result is two side-by-side double-stranded helices linked by two crossovers. Further, sticky ends (overhangs of several unpaired nucleotides at an end of a helix) on the corners of the tiles provide intermolecular interactions that can be programmed to specify how several tiles with different structures will assemble, thus forming periodic nanometer-scale patterns in micron-scale arrays. In addition,, it is possible to incorporate into a tile a third junction that forms a DNA hairpin roughly perpendicular to the plane of the other two helices. This extra structural domain provides a topographic marker that can be detected by atomic force microscopy (AFM) and so easily mark tiles in an array that have the extra domain. A useful tile can also be made from DNA triple-crossover (TX) motifs, which contain three coplanar double helices linked at

each of four crossover points (that is, with each neighboring pair of helices linked by two crossovers), fitted with sticky ends at the corners to program assembly into two-dimensional arrays (5).

Two dimensional arrays built from self-assembled DNA tiles are not restricted to periodic arrays. In the process of algorithmic assembly, DNA tiles interact via programmed sticky ends, but the sticky ends are designed to perform a computation so that the resulting arrangement of tiles does not display a simple periodicity. Algorithmic assembly to produce aperiodic arrangements of tiles demands greater stringency in the assembly of tiles via sticky ends than does the production of periodic arrays because the correct tile for each position has to compete with partially correct tiles as well as with incorrect tiles. As a first step, algorithmic assembly of triple-crossover molecules designed with sticky ends encoding the assembly rule “exclusive OR” (XOR) was used to perform four steps of a logical operation that yields a one-dimensional, four-byte, aperiodic structure incorporating ten TX molecules (6).

The strategy of algorithmic self-assembly was extended from one dimension to two-dimensional lattices by use of XOR algorithms encoded in DX molecules to fabricate a fractal pattern (7). Although limited by error rates in the range of 1 % to 10 %, the result demonstrates that engineered self-assembly of DNA tiles is “capable of implementing any desired algorithm for computation or construction tasks.” One commentator noted the technical difficulties that were faced in this accomplishment (8). “This study is conceptually straightforward, but the experimental challenges are tremendous. One key challenge is assembly fidelity. The right molecules have to compete with partially matched molecules. The concentrations of the competing molecules further complicate the fidelity issue, as some molecules could be rapidly depleted from the solution. In that sense, the current work is quite stunning even though the assembly is far from perfect.” Subsequent work demonstrating the computational primitives copying and counting (9) “provides further evidence that algorithmic self-assembly provides a general mechanism for universal construction in the sense of von Neumann.”

## Building DNA Nanotubes

In addition to the planar tiles formed from DX and TX motifs, it is possible to build DNA nanotubes from motifs designed to not be planar. By properly designing the crossovers between helical domains, a six-helix bundle can be formed from six DNA double helices that are connected to each other at two crossover sites (10). The six helices form a DNA nanotube with a hexagonal cross-section and a central hole about the diameter of the DNA double helix—2.0 nm. If these motifs are designed so that overhangs on the two ends of each helix are complementary to each other, then the six-helix bundles self-assemble to form one-

dimensional arrays—rather stiff wires more than 7  $\mu\text{m}$  long, as little curvature can be seen in AFM images. The authors note such stiff nanostructures might be useful as nanomechanical struts. If two different tiles are used and the sticky ends are configured such that the front of one helix will pair with the back of another and some pairs of ends are left blunt, then the tiles can be made to assemble in a two-dimensional array. Depending on which pairs of ends are left blunt, slightly different arrays will be formed. The authors note that the inner or outer surfaces could also be prepared without the negative charge associated with DNA by constructing the motif from peptide nucleic acids (PNA) or other uncharged variants on the nucleic acid theme. More significantly for productive nanosystems development, the surfaces of these six-helix bundles could be used to mount other motifs and nanodevices that could be oriented in specified directions. Theoretical analysis of minimally strained nucleic acid nanotubes reveals that a wide variety of DNA nanotubes, as well as similar nanotubes constructed from RNA and PNA, could provide tubes with specific inner and outer radii and with multiple lobes (11). Such tubes could be useful as both scaffolding and custom-shaped enclosures for other nanostructures.

DNA nanotubes can also be constructed to assemble as a sheath encasing some other nanostructure (12). To avoid the difficulty of threading a nanostructure through a DNA nanotube sheath, nanotubes were constructed as half tubes to be joined in pairs to form a complete sheath. In the simpler case, two bent triple-crossover (BTX) molecules were constructed in which the three helix axes form an angle of 120 degrees—the internal angle of a regular hexagon. Joining the two BTX molecules face-to-face produced the desired six-helix nanotube. In the case of joining two four-helix bundles, however, the designed angles differed from the internal angle of a regular octagon, producing a more ellipsoidal cross-section in the resulting eight-helix nanotube. In both 6-helix and 8-helix cases, nanotubes of length several hundred nm to several  $\mu\text{m}$  were assembled by combining two components, each of which forms half the circumference of the final nanotube. The potential ability to sheath guest nanostructures in DNA nanotubes could provide a way to organize networks of those guest structures in space by way of the addressable assembly of DNA nanotubes.

Nanotubes have also been formed unexpectedly from DNA tiles designed for other purposes. The 4 x 4 tile was designed by linking 4 4-arm junctions to form a cross in which each of the four arms is composed of two crossover-linked DNA helices (13). Fortuitously, small variations in the design of this type of DNA tile caused the tile to assemble into either a ‘nanoribbon’ or a two-dimensional ‘nanogrid’. Short single strand loops (bulged loops) were designed into each corner of the core of the 4 x 4 tile to encourage the 4 arms to point in separate directions. 4 x 4 tiles were designed in two different ways with sticky ends

added to the four arms to program the assembly of the tiles. Both designs give square lattices, providing a periodic array of square cavities. With one design, the distance between centers of adjacent tiles is an even number of helical half-turns. The square lattices that result have center-to-center distances of 17.6 nm and take the form of nanoribbons about 60 nm wide and several microns long, thought to result from tube-like structures that flatten when the lattice is deposited on a surface for AFM analysis. Because the first design results in a lattice in which each tile presents the same face to the lattice face, any curvature that might exist in the tile accumulates in neighboring tiles, perhaps causing the lattice to circularize. The second design adds one additional helical half-turn and gives lattices with center-to-center distances of 19.3 nm and a corrugated design in which neighboring tiles face in opposite directions, canceling any curvature. In this case large pieces of lattice several hundred nanometers on a side were observed.

Through systematic study and exploitation of the tendency of some two-dimensional arrays of tiles to fold into tubes, DNA nanotubes of varying diameters have been constructed from tiles made of double-crossover molecules (14). Two DX tiles of the same subtype DAE-E but having different core structures (everything except the four sticky ends on each tile) were used so that self-assembly would yield lattices with stripes—either perpendicular stripes or diagonal stripes depending on how the matching sticky ends are configured. By varying the core sequences and the sticky ends (such as the presence of a hairpin stem-loop protruding from the core, base stacking between the core and the sticky ends, the orientation and spacing of the crossover points, etc.) the authors investigated what influences whether the resulting lattice is flat or a tube, and the characteristics of tubes formed. The nanotubes they formed ranged from 7 to 20 nm in diameter and grow as long as 50  $\mu\text{m}$ , with a persistence length of about 4  $\mu\text{m}$ —almost a hundred times the persistence length of double strand DNA. “Thus, we believe that the DNA nanotubes described here, together with their design principles and the understanding gained in their characterization, will find significant use in DNA nanotechnology.”

## Assembling Arrays of Guest Molecules in DNA Frameworks

The two-dimensional ‘nanogrid’ arrays formed using 4 x 4 tiles described above have been shown to template the formation of periodic protein arrays (13). The large cavity size and the bulge loops, which can be chemically functionalized, at the center of each 4 x 4 tile provide each square with a potential site for conjugating a molecule so that the lattice could direct the periodic assembly of desired molecules. This capability was demonstrated by incorporating biotin to one loop on each tile and to produce a periodic array of streptavidin (STV) molecules—a protein



widely used in molecular biology because of its extremely strong binding to the vitamin biotin, one of the strongest non-covalent interactions known.

An additional step toward fully programmable DNA-templated protein arrays was taken using the above 4 x 4 tiles to demonstrate precise control over periodic spacing between proteins in protein arrays (15). Two 4 x 4 tiles of different design—following the designs of the nanoribbon-forming tile with 17.6 nm center-to-center distances and the nanogrid-forming tile with 19.3 nm center-to-center distances described in ref. 13—were combined to associate with each other in a pattern of A and B tiles programmed by their sticky ends. Variants of each type were also prepared with and without biotin functionalization. Different sticky end configurations were designed to assemble either a one-dimensional nanotrack or a two-dimensional nanogrid. Nanogrids were assembled from alternating A and B tiles joined at all four arms. One nanogrid was designed with biotin functionalization of every tile, producing a STV grid twice as dense as an alternative in which only one of the two types of tile was functionalized. A one-dimensional nanotrack was assembled from A and B tiles lacking sticky ends on one arm, again in versions with STV on either one tile or both. With both nanogrids and nanotracks AFM imaging revealed the placement of the 4-nm STV bumps to be as expected from the design. “This is one step forward toward more programmable and complex assembly of protein arrays at the nanoscale.” It remains to organize ordered proteins on DNA arrays.

Proteins are not the only potentially useful molecular machines that have been organized in two-dimensional arrays constructed from DNA (16). Through a combination of *in vitro* selection and trial and error, a DNA enzyme was developed—a bi-molecular complex in which a 29-nucleotide catalytic strand will, in the presence of  $\text{Cu}^{2+}$ , cleave a specific position in a 22-nucleotide substrate strand. This self-cleaving DNzyme was incorporated into a two-dimensional array formed from four DX-tiles—designated A, B, C, and D—so that the array consists of vertical columns of tiles repeating in the order A-B-C-D. The DNzyme was added as a loop that protrudes from the surface of the B-tiles and can be imaged by AFM. A DNA hairpin without catalytic activity was similarly added to the D tiles. Since the horizontal length of each tile is 16 nm, the stripes formed by the B and D tiles are spaced 32 nm apart. Before treatment with  $\text{Cu}^{2+}$  the 2D-array showed prominent stripes 31.5 nm apart; after treatment with  $\text{Cu}^{2+}$  the spacing between stripes changed to 61.5 nm, indicating the autocatalytic removal of the DNzyme from the B tiles, demonstrating that a DNzymes immobilized in an array of DNA tiles remains active. Because it is possible to develop DNzymes with diverse catalytic activities, and because it is possible to arrange DNA tiles in complex patterns, both periodic and aperiodic (see also the section on scaffolded DNA origami in the accompanying report “Nucleic acid

engineering”), it seems likely that much more complex patterns of catalytic functions can be developed.

Two-dimensional arrays of DNA tiles can also be used to organize patterns of more than one component. A lattice self-assembled from four component DX tiles in which two different single strand DNA sequences (capture sequences) protrude from tiles B and D affords positions to attach two different components bearing DNA strands complementary to the capture sequences (17). The tiles were designed so the capture sequences both project from the same face of the lattice scaffolding, and so the A and C tiles provide 32-nm spacing between the rows of B and D tiles. Gold nanoparticles of 10- and 5-nm diameter were coated with DNA to complement the capture sequences on the B and D tiles, respectively. An additional hairpin on the face of the D tiles opposite the face with the capture strands provides a topological marker for AFM imaging of assembled lattices. Because each gold nanoparticle is coated with multiple strands of DNA (5 to 10 for 5 nm-diameter particles and 60-70 per 10-nm particle), each particle can attach to more than one tile. Each particle size was found by AFM to be almost exclusively localized to the row bearing the appropriate capture strand.

Another demonstration of the deliberate and precise organization of nanoparticles into specific designed structural arrangements used a more robust DNA motif to more precisely position nanoparticles attached to the scaffolding (18). The motif used is termed a 3D-DX triangle because it is based on a tensegrity triangle in which each edge is a DX molecule, and at each angle of the triangle the two edges cross rather than meet, thus forming an X. Because the three edges of the triangle are not coplanar, the tensegrity triangle is a three dimensional object. It is possible to produce two dimensional lattices with 3D-DX motifs if only two of the three edges end with sticky ends. The third edge, not involved in lattice formation, is left with blunt ends. One of the DNA strands forming a blunt end has a gold nanoparticle attached and is the only DNA strand attached to that nanoparticle. Arrays were formed using two different 3D-DX triangles, with one 5 nm-diameter gold nanoparticle attached to one or both triangles. In another case, a 5 nm-diameter gold nanoparticle was attached to one triangle and a 10 nm-diameter gold nanoparticle was attached to the other. Joining the two edges with sticky ends of each of the two 3D-DX triangles produces a rhombic lattice arrangement. Each triangle edge is 8 turns of the double helix—about 27.2 nm. Electron microscopy of the resulting arrays confirmed the expected spacing of gold nanoparticles of the expected sizes according to the design used. The authors noted that more complex periodic arrangements could be produced by using more tile species, and that algorithmic assembly could be used to produce aperiodic patterns.

## A Two-State DNA Lattice

Using the principle of generating movement in a nanomechanical DNA device by displacing a DNA set strand by addition of a DNA fuel (as described in the accompanying report “Nucleic acid engineering”), a two-state DNA nanoactuator was constructed and then incorporated in a two-dimensional array of DNA nanostructures such that the dimensions of the array were switched between two values by the action of the DNA device (19). In the presence of one set strand, the nanoactuator forms a bulged three-arm branch junction in which the third arm is a 21-nucleotide stem-loop structure. The second set strand is complementary to the entire stem-loop sequence. Adding the first fuel strand removes the first set strand forming an intermediate structure that can then be opened with the second set strand to form a double helix 6.8 nm longer than the bulged three-arm junction. Adding the second fuel strand and first set strand fully reverses the transformation. Consequently operation of the nanoactuator causes an extension-contraction cycle of 6.8 nm (two full turns of the double helix) with a cycle time of about 26 s. The nanoactuators were incorporated into a two-dimensional array in which four-arm branches are fused into a rhombus-like motif that can be made to assemble into a periodic two-dimensional array. The nanoactuators formed two opposite edges of the rhombus, resulting in an array of cavities with dimensions of either 14 x 14 nm or 14 x 20 nm, depending on the operational state of the nanoactuators. “The nanoactuator device constructed here results in a linear translational motion on the lattice.”

## Controlled Movement Along a Lattice

Perhaps even more useful than a DNA lattice that can undergo controlled movement would be DNA devices that could ‘walk’ along a lattice in a precisely controlled fashion. Such devices were developed by four independent research groups (20, 21, 22, 23) and recently reviewed (24, 25).

The biped walking device developed by Sherman and Seeman (20) is powered by the energy released during hybridization of complementary sequences of single strand DNA to form double helical DNA. It is composed of a footpath constructed from a triple crossover molecule, and a biped that consists of two double helices linked by three short, flexible single strand sequences. Extending from one end of each of the two biped double helices is a short single strand ‘Foot’. Extending from one end of each of the three footpath double helices is a short single strand ‘Foothold’. A specific foot attaches to a specific foothold in the presence of the Set Strand that contains the complementary sequence of both foot and foothold. In addition to the complements of the foot and foothold, each set strand has an additional ‘toehold’ sequence by which it can be removed by hybridization with an ‘Unset’ or ‘Fuel’ Strand. One end of

each Unset strand is linked to biotin so that spent duplexes of Set and Unset Strand can be removed by STV-covered magnetized beads. If the two feet are designated 1 and 2, and the three footholds are designated A, B, and C, then the cycle begins in State 1A, 2B with Set Strand 1A binding Foot 1 to Foothold A and set strand 2B binding Foot 2 to Foothold B. Unset Strand 2B is added to release Foot 2 from Foothold 2B so that Foot 2 is connected to the footpath only through the flexible links to Foot 1 and Set Strand 1A (State 1A). Because the flexible linkers need to be able to extend to Foothold C they need to be able to extend 2 nm. Set Strand 2C is added to bind Foot 2 to Foothold C (State 1A, 2C). Unset Strand 1A releases Foot 1 from Foothold A (State 2C). Adding Set Strand 2B completes the step binding Foot 1 to Foothold B (State 1B, 2C). The total distance traveled is 2.0 nm—the width of one DNA double helix. In this process, the rear leg always follows, which has been called an inchworm-type gait. In principle, adding more Footholds would enable continued movement, although the device as initially demonstrated is only capable of one step forward or backward as directed by Set Strand addition and removal. The authors note that a circular footpath could generate rotary motion, and that a walker could be adapted to transport a cargo or thread a polymer to some destination.

The DNA walker of Shin and Pierce (21) extends the concept of the walker by demonstrating a processive—the activity continues through successive cycles without dissociation between the device and its substrate—bipedal walker that moves by advancing the trailing foot to the lead with each step. As with the above walker there are four basic components: a walker, a track, attachment (or set) strands, and detachment (or unset or fuel) strands. The walker consists of one 20-base pair helix extending into two 23-nucleotide single strand legs. The strands that compose the track form a double helix from which four 20-nucleotide single strand branches extend every 15 base pairs. Because the two legs are of opposite polarity (that is, one has a free 3’ end and the other a free 5’ end) neighboring branches are of opposite polarity. All branches are on the same side of the helix and 1.5 helical turns (about 5.0 nm) apart. Each attachment strand binds one walker leg to the track by forming an 18-base pair helix with the leg and a 17-base pair helix with the branch. Each attachment strand also has a 10-nucleotide overhang to allow it to be removed by the detachment strand that is its complete complement. Adding the first attachment strand binds the first leg to the first branch; adding the second attachment strand binds the second leg to the second branch. Adding the first detachment strand frees the first leg so that when the third attachment strand is added the first leg can bind to the third branch. And so forth, efficiently achieving unidirectional locomotion.

The device of Tian and Mao uses a similar concept to that of Shin and Pierce, but demonstrates unidirectional rotation (22). Two DNA nanocircles of 6.7 nm diameter form two molecular gears that continuously roll against each other.

Each gear is composed of a central circular DNA strand which is identical for both gears, and a set of three peripheral linear strands, which are unique for each gear. Part of each peripheral strand hybridizes to the central strand to form a circular double helix while the remainder extends from the circle to form one of the single strand gear teeth, so that each gear has three single strand teeth. Rotation is accomplished by successively connecting pairs of gears with linker (set) strands and disconnecting them with removal (unset) strands. Each of the three linker strands consists of a region complementary to one tooth of the first gear, a region complementary to one tooth of the second gear, and a region that remains unpaired so that it can pair with its corresponding removal strand. Adding linker strand 1 joins gears A and B by tooth 1 of each; adding linker strand 2 adds a second junction between A and B by tooth 2; adding removal strand 1 removes the link between the first pair of teeth, leaving the gears joined by the second pair of teeth; etc. “Through engineered DNA nanostructures, we could potentially organize many individual DNA motors to form complicated nanomachines.”

A third concept described by Yan, Turberfield, Reif, and co-workers resembles a bucket being passed along a bucket brigade (23). In this case, the walker—or bucket—is a 6-nucleotide DNA fragment passed along a track with three footholds (or anchorage sites: A, B, C). Unlike the first three walkers, the motion is not driven by the energy of DNA hybridization so there are no set and unset strands. Instead the roles of the set and unset strands are taken by three enzymes, a ligase and two restriction enzymes, each of which cuts DNA at a specific recognition sequence. Without substantial free energy differences among the states of the system, the device is actually an information ratchet, although energy from ATP hydrolysis is required for the ligase to work. The distinguishing feature of this concept is that motion is autonomous, that is, once the device and the three enzymes are mixed together, unidirectional motion proceeds without further manipulation. The track is a 99-base-pair DNA double helix to which three anchorage sites, each of which is a short DNA double helix, is linked by a 4-nucleotide single strand flexible hinge. The hinges allow sufficient movement so that the ends of neighboring anchorage sites can interact via thermal motion. The anchorage sites, each separated from its neighbor by 3 helix turns, initially each consist of a 13-base pair double helix plus a 3-nucleotide single strand extension at the 3' end, except that site A is initially a 16 base pair helix and a 3-nucleotide extension because it initially includes the walker. The walker is a 6-nucleotide fragment initially positioned on the end of site A. The walker consists of two separate 3-nucleotide domains: the base-paired 5'-terminal 3 bases of one strand of site A, and the single strand 3'-extension of the other strand. Consequently the walker is attached to the anchor site covalently. As thermal motion brings the ends of sites A and B into contact, the 3-nucleotide extensions of

each hybridize joining A and B. Ligation creates a site for a certain restriction enzyme PflM I to cut, chosen such that cleavage transfers the walker to site B and destroys the recognition site for PflM I. Once the walker is transferred to B, the new sticky end of B is complementary to the sticky end of C. The ligation of these ends produces a recognition site for a second enzyme, BstAP I. Cutting by the second enzyme transfers the walker to the C site and destroys the recognition site for BstAP I. The key feature of each restriction enzyme chosen for this device is that they both cut in a non-specific region between the two halves of their recognition site. Each ligation creates a new restriction site and each cut destroys the previous restriction site so that the walker can not move backwards. It can ‘idle’ between A and B and between B and C, but once it has been ligated to C it can never return to A. “By encoding information into the walker and the anchorages, it should be possible to develop the device into a powerful autonomous computing device (and hence an ‘intelligent’ robotics device)”

An interesting variation on the above walkers is a device that processively and autonomously moves along a DNA track, extracting chemical energy from its track as it moves, but destroying the track in the process (26). The walker is a DNzyme that cleaves RNA between an unpaired purine (A or G) ribonucleotide and a paired pyrimidine (C or U) ribonucleotide. It is comprised of a 15-deoxynucleotide catalytic domain flanked by two substrate recognition domains of 7 or more deoxynucleotides. The track is a DNA double helix with four single strand extensions—which provide the anchor sites for the walker—spaced 20 base pairs apart. Each single strand DNA extension from the track contains the two-part recognition site for the DNzyme that flanks a sequence of two ribonucleotides at which the DNzyme will cut. The anchorage sites are thus also substrate sites for the DNzyme and are chimeras consisting of two ribonucleotides and the remainder deoxynucleotides. Two T nucleotides at the base of each extension provide a flexible connection between the walker-binding site and the DNA double helix track. The two recognition sites are of unequal length—the one nearer the track is 15 nucleotides and the one on the opposite side of the cleavage site is 7 nucleotides. After the DNzyme binds to a site and cleaves its substrate, the short distal fragment dissociates but the DNzyme remains bound by the longer proximal substrate recognition site. The now unpaired short arm of the DNzyme searches for another substrate recognition sequence and thus pairs with the neighboring site because it presents a more stable intramolecular pairing. Branch migration then causes the DNzyme to move to that neighboring site, repeating the process of cleavage and movement. The DNzyme can move in either direction.

## Ribosome-Class Covalent Assembly

Given that DNA and devices made from DNA can be used to assemble lattices, tracks, and other supramolecular structures, and that some control of mechanical motion and position in such structures has been demonstrated, is it possible to mimic the action of the ribosome in executing covalent assembly according to programmed instructions? Liao and Seeman have provided a demonstration that a DNA nanomechanical device can program the synthesis of a linear polymer by aligning the positions of reactants (27). The device aligns a series of molecules in specific positions and then links them in a specified order. This demonstration is based upon a device Seeman and his collaborators previously described (see accompanying report “Nucleic acid engineering”) in which robust rotary motion is achieved by using a sequence of addition of set and unset (fuel) strands to interconvert two DNA crossover motifs termed PX and JX<sub>2</sub>. Two PX-JX<sub>2</sub> devices were incorporated in a linear array with five diamond-shaped motifs constructed from DNA double-crossover molecules. At the left of the first PX-JX<sub>2</sub> device is diamond I (above the axis formed by the PX-JX<sub>2</sub> devices); diamonds II and III are joined side-by-side via a PX linkage to form a double-diamond-shaped wing between the two PX-JX<sub>2</sub> devices (II above and III below); diamonds IV and V form a similar double-diamond-shaped wing to the right of the second PX-JX<sub>2</sub> device (IV above and V below). In this initial orientation, sticky end 1 is at the right of I; sticky ends 2 and 4 are at the left and right respectively of II and similarly 3 and 5 on the left and right of III; 6 is on the left of IV and 7 is on the left of V. The relative orientations of the sticky ends can, however, be changed by changing the state of the PX-JX<sub>2</sub> devices. For example, if both PX-JX<sub>2</sub> devices are in the PX state in the initial configuration, changing the state of the second device to the JX<sub>2</sub> state reverses the positions of diamonds IV and V so that 4 juxtaposes 7 instead of 6. The sticky ends are available to bind to sticky ends of double crossover molecules. Six different DX molecules each have a pair of sticky ends: 1-2, 1-3, 4-6, 5-6, 4-7, 5-7. Depending on how the PX-JX<sub>2</sub> devices are set, a different pair of DX molecules will be oriented to be joined. The actual joining occurs by subsequent enzymatic ligation. The state PX1-PX2 aligns DX molecules 1-2 and 4-6. The state PX1-JX<sub>2</sub>2 aligns 1-2 and 4-7. The state JX<sub>2</sub>1-PX2 aligns 1-3 and 5-7. The state JX<sub>2</sub>1-JX<sub>2</sub>2 aligns 1-3 and 4-6. Consequently the sequence of the product is determined by the program of set and unset strands used to determine the state of the device. (The product is actually one continuous strand from the joined DX molecules—the remainder of each DX is analogous to the adapter molecule tRNA in protein synthesis) The device thus translates a DNA signal into a DNA sequence determined by but unrelated to the sequence of the signal. The authors expect to be able to add chemically reactive groups to the DNA backbone so that this method could be adapted to construct novel polymers. They also suggest it

might be possible to mimic the translocation function of the ribosome in future adaptations of this system so that the size of the product would not necessarily be restricted to the size of the device.

Ding and Seeman have further demonstrated that a DNA nanomechanical device can be operated at a specific location within a crystalline two-dimensional lattice structure (28). They developed a cassette that contains a rotary device coupled to a component that allows it to be inserted into a specific site in an array and a component that enables the rotational state of the device to be determined by AFM. The nanomechanical device used is again the rotary PX-JX<sub>2</sub> device incorporated into the four-state polymer assembly device described in the preceding paragraph. The reporter component is a hairpin helix that protrudes from one side of the PX-JX<sub>2</sub> device. The PX-JX<sub>2</sub> device is joined to a third helix with sticky ends that enable insertion into an array. The array was formed from 8 unique triple crossover (TX) DNA tiles and also incorporates a marker tile that can also be imaged by AFM. The position of the reporter hairpin with respect to the marker tile reveals whether the cassette is in the PX or JX<sub>2</sub> position. AFM reveals that the cassette can be inserted into the array in either the PX or JX<sub>2</sub> position, and after treatment with the appropriate set strands the array of devices is converted to the opposite configuration. The AFM images were only good enough to determine the configuration of roughly half the inserted arrays, but of those that could be determined, almost 99 % were converted to the opposite configuration after treatment. As the authors point out, only one type of device was inserted into these arrays, but there is reason to believe that several devices could be arrayed and independently addressed, as two devices were independently addressed in the ribosome-mimic in the previous paragraph. The 8-tile TX array is technically difficult, but the scaffolded origami method (see accompanying report “Nucleic Acid Engineering”) is expected to facilitate demonstration of more complex arrays of devices, and other DNA nanostructures might enable other types of arrangements of devices.

## References

1. A DNA-based method for rationally assembling nanoparticles into macroscopic materials. Chad A. Mirkin, Robert L. Letsinger, Robert C. Mucic & James J. Storhoff. *Nature* **382**, 607-609 (1996) <http://dx.doi.org/10.1038/382607a0>
2. Organization of ‘nanocrystal molecules’ using DNA. A. Paul Alivisatos, Kai P. Johnsson, Xiaogang Peng, Troy E. Wilson, Colin J. Loweth, Marcel P. Bruchez Jr & Peter G. Schultz. *Nature* **382**, 609-611 (1996) <http://dx.doi.org/10.1038/382609a0>
3. Sequence-specific molecular lithography on single DNA Molecules. Kinneret Keren, Michael Krueger,



- Rachel Gilad, Gdalyahu Ben-Yoseph, Uri Sivan, Erez Braun. *Science* **297**, 72-75 (2002)  
<http://dx.doi.org/10.1126/science.1071247>
4. Design and self-assembly of two-dimensional DNA crystals. Erik Winfree, Furong Liu, Lisa A. Wenzler and Nadrian C. Seeman. *Nature* **394**, 539-544 (1998)  
<http://dx.doi.org/10.1038/28998>
  5. Construction, analysis, ligation, and self-assembly of DNA triple crossover complexes. Thomas H. LaBean, Hao Yan, Jens Kopatsch, Furong Liu, Erik Winfree, John H. Reif, and Nadrian C. Seeman. *Journal of the American Chemical Society* **122**, 1848-1860 (2000)  
<http://dx.doi.org/10.1021/ja993393e>
  6. Logical computation using algorithmic self-assembly of DNA triple-crossover molecules. Chengde Mao, Thomas H. LaBean, John H. Reif and Nadrian C. Seeman. *Nature* **407**, 493-496 (2000)  
<http://dx.doi.org/10.1038/35035038> Erratum: *Nature* **408**, 750 (2000)
  7. Algorithmic self-assembly of DNA Sierpinski triangles. Paul W. K. Rothmund, Nick Papadakis, Erik Winfree. *PLoS Biol* **2**(12): e424 (2004)  
<http://dx.doi.org/10.1371/journal.pbio.0020424>
  8. The emergence of complexity: Lessons from DNA. Mao C. (2004) *PLoS Biol* **2**(12): e431  
<http://dx.doi.org/10.1371/journal.pbio.0020431>
  9. Two computational primitives for algorithmic self-assembly: Copying and counting. Robert D. Barish, Paul W. K. Rothmund, and Erik Winfree. *Nano Letters* **5**, Vol. 5, 2586-2592 (2005)  
<http://dx.doi.org/10.1021/nl052038l>
  10. Six-helix bundles designed from DNA. Frederick Mathieu, Shiping Liao, Jens Kopatsch, Tong Wang, Chengde Mao, and Nadrian C. Seeman *Nano Letters* **5**, 661-665 (2005) <http://dx.doi.org/10.1021/nl050084f>
  11. Design of minimally strained nucleic acid nanotubes. William B. Sherman and Nadrian C. Seeman. *Biophysical Journal* **90**, 4546-4557 (2006)  
<http://dx.doi.org/10.1529/biophysj.105.080390>
  12. Six-helix and eight-helix DNA nanotubes assembled from half-tubes. Akinori Kuzuya, Risheng Wang, Ruojie Sha, and Nadrian C. Seeman. *Nano Letters* **7**, 1757-1763 (2007) <http://dx.doi.org/10.1021/nl070828k>
  13. DNA-templated self-assembly of protein arrays and highly conductive nanowires. Hao Yan, Sung Ha Park, Gleb Finkelstein, John H. Reif, Thomas H. LaBean. *Science* **301**, 1882-1884 (2003)  
<http://dx.doi.org/10.1126/science.1089389>
  14. Design and Characterization of Programmable DNA Nanotubes. Paul W. K. Rothmund, Axel Ekani-Nkodo, Nick Papadakis, Ashish Kumar, Deborah Kuchnir Fyngenson, and Erik Winfree. *Journal of the American Chemical Society* **126**, 16344-16352 (2004)  
<http://dx.doi.org/10.1021/ja044319l>
  15. Programmable DNA self-assemblies for nanoscale organization of ligands and proteins. Sung Ha Park, Peng Yin, Yan Liu, John H. Reif, Thomas H. LaBean, and Hao Yan. *Nano Letters* **5**, 729-733 (2005)  
<http://dx.doi.org/10.1021/nl050175c>
  16. Functional DNAzymes organized into two-dimensional arrays. Alejandra V. Garibotti, Scott M. Knudsen, Andrew D. Ellington, and Nadrian C. Seeman. *Nano Letters* **6**, 1505-1507 (2006)  
<http://dx.doi.org/10.1021/nl0609955>
  17. Sequence-encoded self-assembly of multiple-nanocomponent arrays by 2D DNA scaffolding. Yariv Y. Pinto, John D. Le, Nadrian C. Seeman, Karin Musier-Forsyth, T. Andrew Taton, and Richard A. Kiehl. *Nano Letters* **5**, 2399-2402 (2005)  
<http://dx.doi.org/10.1021/nl0515495>
  18. Two-dimensional nanoparticle arrays show the organizational power of robust DNA motifs. Jiwen Zheng, Pamela E. Constantinou, Christine Micheel, A. Paul Alivisatos, Richard A. Kiehl, and Nadrian C. Seeman. *Nano Letters* **6**, 1502-1504 (2006)  
<http://dx.doi.org/10.1021/nl060994c>
  19. A two-state DNA lattice switched by DNA nanoactuator. Liping Feng, Sung Ha Park, John H. Reif, and Hao Yan. *Angewandte Chemie International Edition* **42**, 4342-4346 (2003).
  20. A precisely controlled DNA biped walking device. William B. Sherman and Nadrian C. Seeman. *Nano Letters* **4**, 1203-1207 (2004)  
<http://dx.doi.org/10.1021/nl049527q>
  21. Synthetic DNA walker for molecular transport. Jong-Shik Shin and Niles A. Pierce. *Journal of the American Chemical Society* **126**, 10834-10835 (2004)  
<http://dx.doi.org/10.1021/ja047543j>
  22. Molecular gears: a pair of DNA circles continuously rolls against each other. Ye Tian and Chengde Mao. *Journal of the American Chemical Society* **126**, 11410-11411 <http://dx.doi.org/10.1021/ja046507h>
  23. A unidirectional DNA walker that moves autonomously along a track. Peng Yin, Hao Yan, Xiaoju G. Daniell, Andrew J. Turberfield, and John H. Reif. *Angewandte Chemie International Edition* **43**, 4906-4911 (2004)  
<http://dx.doi.org/10.1002/anie.200460522>
  24. Molecular motors: synthetic DNA-based walkers inspired by kinesin. T. Ross Kelly. *Angewandte Chemie International Edition* **44**, 4124-4127 (2005)  
<http://dx.doi.org/10.1002/anie.200500568>



25. Synthetic molecular motors and mechanical machines. Euan R. Kay, David A. Leigh, Francesco Zerbetto. *Angewandte Chemie International Edition* **46**, 72-191 (2006) <http://dx.doi.org/10.1002/anie.200504313>
26. A DNAzyme that walks processively and autonomously along a one-dimensional track. Ye Tian, Yu He, Yi Chen, Peng Yin, Chengde Mao. *Angewandte Chemie International Edition* **44**, 4355-4358 (2005) <http://dx.doi.org/10.1002/anie.200500703>
27. Translation of DNA signals into polymer assembly instructions. Shiping Liao and Nadrian C. Seeman. *Science* **306**, 2072-2074 (2004) <http://dx.doi.org/10.1126/science.1104299>
28. Operation of a DNA robot arm inserted into a 2D DNA crystalline substrate. Baoquan Ding and Nadrian C. Seeman. *Science* **314**, 1583-1585 (2006) <http://dx.doi.org/10.1126/science.1131372>



## Self-Assembly

### Introduction

Self-assembly is the spontaneous aggregation of molecules (or particles) to form ordered, organized arrays. This aggregation can be driven by a number of different attractive forces, such as van der Waals attractive forces, Coulombic attraction, dipole-dipole interactions, hydrogen bonding, acid-base interactions, etc. Self-assembly can be used to create sheets, ribbons, helices and complex three-dimensional architectures, based on the nature and orientation of these intermolecular forces.

### Self-Assembled Monolayer Arrays

When these forces combine to create a single layer of molecules on a surface or interface, the product formed is called a self-assembled monolayer (or SAM). SAM formation also typically involves some sort of favorable interaction between the molecule's head group and the surface (e.g., the gold surface and a thiol). The stability of the monolayer is often dictated by the strength of this interaction – weakly held molecules produce monolayers that are easily disrupted, strongly held molecules produce monolayers that are more robust. The kinds of applications that a monolayer can be applied towards are dictated by the stability of that monolayer under those particular conditions. For example, one of the most widely studied types of self-assembled monolayers is the organothiol on gold. These monolayers are very easy to make and a wide variety of these monolayers have been made and characterized. They have been widely used in a variety of sensing devices such as chemically modified electrodes, SAW devices, and QCMs. However, the thiolate head group is subject to oxidation and these monolayers are thermally labile above about 70°C, making these materials unsuitable for sensing applications that might encounter these conditions (e.g., exhaust gas monitoring).

Another class of molecules that have been widely used to form self-assembled monolayers is the organosilanes. In this case, they must first be hydrolyzed to form the hydroxysilane intermediate, which is the key component that undergoes the self-assembly process. In this case, the attractive interaction between the head group and the surface is a hydrogen bond between the hydroxysilane and the oxide surface. As the hydroxysilanes aggregate, making a macromolecular aggregate, the hydroxysilanes slowly start to undergo condensation chemistry, both among themselves and with the oxide surface, ultimately resulting in a covalently anchored, and crosslinked monolayer system.

### Templates

Self-assembly is not only useful in the synthesis of organized macromolecular arrays, but also in the formation of templates to make complex three-dimensional architectures. Self-assembly forces are also responsible for the formation of micelles and vesicles when surfactant molecules are dissolved in water. Micelles and vesicles can be used as templates in the synthesis of nanostructured materials (e.g., ceramic oxides, phosphates, etc.). For example, when certain types of micelles are exposed to silicate sol-gel reaction conditions, it is possible to wrap the ceramic phase around the micelle structure and make a highly porous silicate product. The pore structure of these materials is directly related to the original micelle diameter, and since these dimensions are between those commonly encountered for zeolites (15Å or less) and macroporous materials (300Å or more), these materials are commonly referred to as “mesoporous” materials.

The silicate coated micelle can also participate in a self-assembly process. As these macromolecular assemblies precipitate out of solution, they commonly form an ordered, organized array. Depending on reaction conditions, it is possible to make hexagonal, cubic, lamellar, or bicontinuous phase products. Thus, the first generation of self-assembly is the orderly aggregation of the surfactant molecules to form the micelle, and the second generation of self-assembly is the aggregation of the silicate coated micelle to form the mesostructured greenbody. The surfactants are generally removed via calcination, which simultaneously serves to rigidify the ceramic backbone, exposing the latent pore structure.

This provides a very high surface area support for catalyst, sorbent and sensing/detection applications. Because these pores are generally larger than simple organosilanes, it is possible to functionalize these internal pore surfaces using a third generation of self-assembly by installing a self-assembled monolayer on this mesoporous framework. If these organosilanes are terminated with chemically specific binding sites, it is possible to create an ordered hierarchical array of binding sites that have high chemical affinity for a wide variety of target species. For example, if we line the pores with alkylthiols, we create a nanoporous sorbent that has exceptionally high affinity for “soft” heavy metals like Hg, Cd, Ag and Pb. Heavy metal sorption kinetics are quite fast (often complete in a few minutes) and selectivity in the presence of common ions (like Na, Ca, Fe, etc.) is excellent. These self-assembled monolayers on mesoporous supports (SAMMS™) are thus arrived at via three successive generations of self-assembly (surfactants to micelles, sol-gel micelles to mesostructured

greenbody, and functionalization via self-assembled monolayers), and have been tailored for effective separations of a wide variety of environmentally problematic species (e.g., heavy metals, radionuclides, oxometallate anions, cesium, iodine, etc.).

### **Intellectual Property**

The patents covering the SAMMS™ technology have been licensed by Steward Environmental Solutions (SES) for fluid treatment in most fields while additional licenses are pending in other areas. SES is currently producing thiol-SAMMS™ for the removal of Hg from industrial process streams (e.g., coal, petroleum, chlor-alkali, mining, etc.). Other environmental remediation targets are being pursued with thiol-SAMMS™ as well as other versions of SAMMS™.

### **Points of Contact**

Glen Fryxell (glen.fryxell@pnl.gov) (technical questions)

Richard Skaggs (Richard.skaggs@pnl.gov) (business opportunities and demonstrations)

Bob Jones (rjones@stewardsolutions.com) (SAMMS™ availability and pricing)

## Protein Bioengineering Overview

The fact that proteins have a precise arrangement of atoms due to their well-defined secondary and tertiary structure makes them well-suited for atomically precise manufacturing. Proteins are also inherently highly functional due to the wide range of peptide residue side chains. This combination of structural and side chain variability is responsible for the wide range of functions that proteins carry out in living organisms ranging from catalytic enzymes to molecular motors to structural components of cells and tissue. Hence, proteins are natural candidates as both building blocks and active working components of productive nanosystems. To date, proteins have been widely utilized in nanoscience. They have been employed to guide nanoparticle growth and organization, and as working

components in nanoscale sensors in which proteins actively mediate properties of quantum dots or other nanoparticles in response to external stimuli. While nature has furnished us with a vast assortment of proteins, all of these proteins were selected for the ultimate goal of organism survival, and not for our purposes of nanofabrication. However, new advances in biotechnology offer exciting prospects for tailor-made proteins with applications in nanoscience. By harnessing biological processes we can find viable approaches to utilizing nature's toolbox in our construction of nanoscale devices and machinery. From this perspective an important goal of biotechnology is to develop protein engineering methods to create new proteins or modifications of existing proteins for integration into hybrid nanodevices.

## Engineering New Proteins for Nano Manufacturing

### Combinatorial Approaches

Biological, combinatorial libraries are based on the manipulation of an organism's DNA sequence (e.g. virus, bacteria, or yeast) to produce random peptides on the exterior of the organism. With the invention of polymerase chain reaction (PCR), this process can be automated to create libraries containing up to a billion different peptide sequences for simultaneous exposure to the inorganic material.<sup>4-11</sup> Through repeated exposure of the biologically based library to the inorganic material of interest, such as quantum dots, magnetic materials, or other nanoscaled materials, peptide sequences with the highest affinities towards the material are selected as described in Figure 1. Some sequences selected in this manner have been shown to preferentially bind to the material from which they were selected over other chemically and structurally similar materials, while other sequences may bind to a range of materials.<sup>5,8</sup>

Applications for selectively binding peptides include:

- Virus-based templates for controlling the manufacture and placement of nanomaterials<sup>12-14</sup>
- Control of crystal formation and composition<sup>6,10,15-21</sup>
- Peptide-based control over the 3-D assembly of nanoparticles<sup>16,22,23</sup>
- Formation of hybrid organic-inorganic materials.<sup>24</sup>

Challenges:

- Mechanism of peptide-surface interactions are often poorly understood and therefore difficult to control.
- Large variability in sequences isolated by various researchers using these techniques.

- Nanoscale patterning of peptides prior to nanoparticle introduction important for bottom-up assembly (may be made possible through dip-pen nanolithography).

Opportunities:

- Multifunctional peptides can be created for three-dimensional assembly of nanoscaled materials.<sup>15</sup>
- Biomimetic self-assembly approaches to APM may lead to improvements in a range of applications, including those related to energy such as the creation of flexible Li-ion batteries for energy storage.<sup>13</sup>

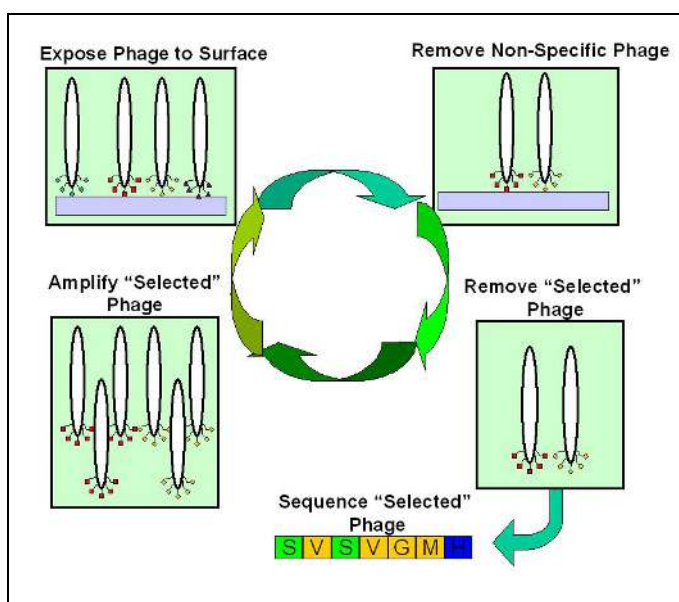

**Figure 1. Combinatorial selection of peptides for nanoscale fabrication using a phage display library.**



- Future biomedical applications of peptide-synthesized nanoscale materials, including the delivery of therapeutics to cells<sup>25</sup>

### *Design of Self Assembling Proteins for Nanoscale Assembly*

As researchers strive to develop new protein sequences for nanomanufacturing by employing methods such as combinatorial selection, others are working with modified versions of existing proteins, protein fragments and *de novo* designed sequences. An attractive property of many proteins is their ability to aggregate or self-assemble into precise structures. Forming structures that are organized on atomic and molecular length scales is precisely the definition of nanomanufacturing. Actin filaments and viral surface proteins are two examples in which proteins self-organize into structural components. Viral coat proteins have been used to form well-defined, nanometer scale rods and doughnuts.<sup>26</sup> In turn, genetic engineering of the viral proteins enables the precise placement of nanoparticles along the self assembled structures.<sup>27</sup> In using virus proteins, researchers have exploited existing proteins. To move beyond the proteins provided by nature, *de novo* design will be an important path to attaining proteins specifically engineered for nanofabrication.<sup>28-30</sup> Self assembly of nanoparticles using designed peptides has been demonstrated and it was shown that assembly can be triggered by taking advantage of folding transitions induced by pH<sup>31</sup> or by other external triggers such as light.<sup>23</sup> Precise placement and spacing of nanometer scale objects using proteins has been achieved by using a coiled-coil motif to link gold nanoparticles and carbon nanotubes.<sup>32</sup>

### *Computer Aided de novo Design of Proteins*

As our understanding of the interactions between organic and inorganic materials increases, we are faced with the opportunity to take well-understood systems and improve upon them using computational techniques. Computer aided *de novo* design is such an opportunity. The process of *de novo* design starts with a general structural description and then designs a sequence that will fold to produce that result. Researchers using this technique have managed to improve upon natural protein-protein interactions, including creating new DNA-binding proteins.<sup>33,34</sup> The software program ROSETTA, originally developed by the Baker lab at the University of Washington, focuses on the prediction and design of protein structures, protein folding mechanisms, and protein-protein interactions. This activity has also sparked collaboration among six leading universities to

create the Rosetta Commons (<http://www.rosettacommons.org/>) to advance the field of high resolution protein prediction and design. Rosetta Commons is working to make this software broadly available to the scientific community.

Such “*de novo* design” techniques have been applied to the design of proteins for the improvement of biosensors. Hellinga and coworkers of Duke University Medical Center have used members of an *E. coli* periplasmic binding protein superfamily to design new soluble receptors that can be incorporated into biosensors for trinitrotoluene (TNT) and glucose.<sup>35</sup> The ability to engineer proteins that bind in a specific way to other molecules, build larger structures of protein, and binding biological and non-biological functional molecules, can be harnessed to create “modular molecular composite nanosystems,” another major topic in the Roadmap.

### *Fusion and Pro Tags*

Common fusion tags like glutathione S-transferase are used to produce and purify fusion proteins. These tools combined with structure-based design have been used to link zinc finger peptides and produce artificial poly-finger proteins with high affinity and specificity for DNA.<sup>36</sup> These artificial proteins are promising constructs for assembling DNA and protein components of “modular molecular composite nanosystems”. Automated online methods for rapidly scanning DNA sequences for target binding sites can be found at:

<http://www.scripps.edu/mb/barbas/zfdesign/zfdesignhome.php>

In addition to facilitating protein purification, affinity tags can be used for accurate placement of proteins on or within nanoassemblies. This is critical for reproducible incorporation of proteins into productive nanosystems. Affinity tags such as histidine sequences (his tag), fusing domains, and pro-tags (protein-based tags requiring activation) are important tools in guiding self-assembly of proteins and nanostructures. Mattoussi and coworkers have used an engineered fusion protein that electrostatically binds to the oppositely charged surface of a quantum dot.<sup>37</sup> A linking strategy based on pentahistidine sequences have been used to precisely position lectins on the surface of quantum dots. Changes in the protein structure induced by analyte binding affects the quantum dot emission thus creating a reagentless small molecule sensor.<sup>38</sup> This approach has successfully been employed to detect water soluble molecules in solution down to the single particle level.<sup>39</sup> Fusion tags are thus robust and reliable methods for immobilizing proteins at nanoparticle interfaces.

A new and promising approach similar to fusion tags but with the added advantages of providing triggered formation of covalent linkages is that of pro tags. Lewandowski and coworkers have used a penta-tyrosine fusion tag for the tyrosinase-catalyzed conjugation of green fluorescent protein (GFP) to the water soluble polysaccharide chitosan.<sup>40</sup> In this approach tyrosinase activates the tyrosine residues forming orthoquinones which undergo reaction with amine groups. This unique example of protein engineering combined with enzymatic assembly provides greater flexibility than conventional affinity labels. Since this method requires activation and forms an essentially irreversible bond, it can be used as one step in a multi-step fabrication sequence. This has been demonstrated by electrodeposition of chitosan modified with pro-tag bound GFP on to patterned electrodes with good spatial resolution in an impressive example of biofabrication on multiple length scales.<sup>41</sup>

## References

- (1) Mann, S. *J. Mater. Chem.* **1995**, *5*, 935.
- (2) Belcher, A. M.; Wu, X. H.; Christensen, R. J.; Hansma, P. K.; Stucky, G. D.; Morse, D. E. *Nature* **1996**, *381*, 56.
- (3) Zaremba, C. M.; Belcher, A. M.; Fritz, M.; Li, Y. L.; Mann, S.; Hansma, P. K.; Morse, D. E.; Speck, J. S.; Stucky, G. D. *Chemistry of Materials* **1996**, *8*, 679.
- (4) Brown, S. *PNAS* **1992**, *89*, 8651.
- (5) Whaley, S. R.; English, D. S.; Hu, E. L.; Barbara, P. F.; Belcher, A. M. *Nature* **2000**, *405*, 665.
- (6) Naik, R. R.; Brott, L. L.; Clarson, S. J.; Stone, M. O. *Journal of Nanoscience and Nanotechnology* **2002**, *2*, 95.
- (7) Peelle, B. R.; Krauland, E. M.; Wittrup, K. D.; Belcher, A. M. *Langmuir* **2005**, *21*, 6929.
- (8) Brown, S. *Nature Biotechnol* **1997**, *15*, 269.
- (9) Tamerler, C.; Kacar, T.; Sahin, D.; Fong, H.; Sarikaya, M. *Materials Science & Engineering C-Biomimetic and Supramolecular Systems* **2007**, *27*, 558.
- (10) Dickerson, M. B.; Naik, R. R.; Stone, M. O.; Cai, Y.; Sandhage, K. H. *Chem Comm* **2004**, 1776.
- (11) Naik, R. R.; Jones, S. E.; Murray, C. J.; McAuliffe, J. C.; Vaia, R. A.; Stone, M. O. *Advanced Functional Materials* **2004**, *14*, 25.
- (12) Lee, S.-W.; Mao, C.; Flynn, C. E.; Belcher, A. M. *Science* **2002**, *296*, 892.
- (13) Nam, K. T.; Kim, D.-W.; Yoo, P. J.; Chiang, C.-Y.; Meethong, N.; Hammond, P. T.; Chiang, Y.-M.; Belcher, A. M. *Science* **2006**, *312*, 885.
- (14) Slocik, J. M.; Naik, R. R.; Stone, M. O.; Wright, D. W. *Journal of Materials Chemistry* **2005**, *15*, 749.
- (15) Slocik, J. M.; Stone, M. O.; Naik, R. R. *Small* **2005**, *1*, 1048.
- (16) Pender, M. J.; Sowards, L. A.; Hartgerink, J. D.; Stone, M. O.; Naik, R. R. *Nano Lett* **2006**, *6*, 40.
- (17) Tomczak, M. M.; Glawe, D. D.; Drummy, L. F.; Lawrence, C. G.; Stone, M. O.; Perry, C. C.; Pochan, D. J.; Deming, T. J.; Naik, R. R. *J Am Chem Soc* **2005**, *127*, 12577.
- (18) Dickerson, M. B.; Naik, R. R.; Sarosi, P. M.; Agarwal, G.; Stone, M. O.; Sandhage, K. H. *Journal of Nanoscience and Nanotechnology* **2005**, *5*, 63.
- (19) Kramer, R. M.; Li, C.; Carter, D. C.; Stone, M. O.; Naik, R. R. *J Am Chem Soc* **2004**, *126*, 13282.
- (20) Naik, R. R.; Stringer, S. J.; Agarwal, G.; Jones, S. E.; Stone, M. O. *Nature Materials* **2002**, *1*, 169.
- (21) Naik, R. R.; Whitlock, P. W.; Rodriguez, F.; Brott, L. L.; Glawe, D. D.; Clarson, S. J.; Stone, M. O. *Chem Comm* **2003**, 238.
- (22) Tullman, J.; Finney, W. F.; Lin, Y.-J.; Bishnoi, S. W. *Plasmonics* **2007**.
- (23) Slocik, J. M.; Tam, F.; Halas, N. J.; Naik, R. R. *Nano Lett.* **2007**, *7*, 1054.
- (24) Lee, S. W.; Mao, C. B.; Flynn, C. E.; Belcher, A. M. *Science* **2002**, *296*, 892.
- (25) Rozenzhak, S. M.; Kadakia, M. P.; Caserta, T. M.; Westbrook, T. R.; Stone, M. O.; Naik, R. R. *Chem Comm* **2005**, 2217.
- (26) Daube, S. S.; Arad, T.; Bar-Ziv, R. *Nano Lett.* **2007**, *7*, 638.
- (27) Yi, H.; Nisar, S.; Lee, S. Y.; Powers, M. A.; Bentley, W. E.; Payne, G. F.; Ghodssi, R.; Rubloff, G. W.; Harris, M. T.; Culver, J. N. *Nano Lett.* **2005**, *5*, 1931.
- (28) Beniash, E.; Hartgerink, J. D.; Storrie, H.; Stendahl, J. C.; Stupp, S. I. *Acta Biomater* **2005**, *1*, 387.
- (29) Jurgen M. Smeenk, M. B. J. O. J. T. D. A. T. H. G. S. J. C. M. v. H. *Angewandte Chemie International Edition* **2005**, *44*, 1968.
- (30) Schneider, J. P.; Pochan, D. J.; Ozbas, B.; Rajagopal, K.; Pakstis, L.; Kretsinger, J. *J. Am. Chem. Soc.* **2002**, *124*, 15030.
- (31) Guo, Y.; Ma, Y.; Xu, L.; Li, J.; Yang, W. *J. Phys. Chem. C* **2007**, *111*, 9172.

- 
- (32) Contarino, M. R.; Sergi, M.; Harrington, A. E.; Lazareck, A.; Xu, J.; Chaiken, I. *Journal of Molecular Recognition* **2006**, *19*, 363.
- (33) Baker, D. *The Scientist* **2006**, 26.
- (34) Kortemme, T.; Baker, D. *Curr. Opin. Chem. Biol.* **2004**, *8*, 91.
- (35) Looger, L. L.; Dwyer, M. A.; Smith, J. J.; Hellinga, H. W. *Nature* **2003**, *423*, 185.
- (36) Kim, J.-S.; Pabo, C. O. *Proceedings of the National Academy of Science U. S. A.* **1998**, *95*, 2812.
- (37) Mattoussi, H.; Mauro, J. M.; Goldman, E. R.; Anderson, G. P.; Sundar, V. C.; Mikulec, F. V.; Bawendi, M. G. *J Am Chem Soc* **2000**, *122*, 12142.
- (38) Medintz, I. L.; Clapp, A. R.; Melinger, J. S.; Deschamps, J. R.; Mattoussi, H. *Adv Mater* **2005**, *17*, 2450.
- (39) Pons, T.; Medintz, I. L.; Wang, X.; English, D. S.; Mattoussi, H. *J Am Chem Soc* **2006**, *128*, 15324.
- (40) Lewandowski, A. T.; Small, D. A.; Chen, T. H.; Payne, G. F.; Bentley, W. E. *Biotechnol Bioeng* **2006**, *93*, 1207.
- (41) Yi, H. M.; Wu, L. Q.; Bentley, W. E.; Ghodssi, R.; Rubloff, G. W.; Culver, J. N.; Payne, G. F. *Biomacromolecules* **2005**, *6*, 2881.

# Synthetic Chemistry

## Introduction

Synthetic chemistry is the system of techniques, methodologies, mechanisms, and tools by which the macroscale, laboratory manipulation of atoms and molecules is possible for the generation of new chemical products. Synthetic chemistry, or chemical synthesis, encompasses a very broad range of research areas that all effort the increasing control over the generation of new matter by way of the manipulation of simpler starting materials. Synthetic chemistry represents the most highly developed form of atomic manipulation available to researchers for the generation of new materials, while providing many of the fundamental building blocks employed by other fields for the generation of larger, more complex nanostructures. The general description of synthetic chemistry provided here is limited in scope to broad topics and not specific chemical reactions, focusing on synthetic issues relevant to the change of covalent bonds for the formation of new molecules from starting materials.

## Organic Synthesis and Natural Products Chemistry

The most highly developed and, through its continued development, the most versatile form of chemical manipulation for molecules and macromolecules is organic synthesis. The structural complexity that comes from organic synthesis arises from the stable chemical bonds that form between carbon atoms and the elements most important to, among others, biological processes (hydrogen, oxygen, nitrogen). The chemical bonds formed from these atoms are not only highly stable, but highly localized to nearest-neighbor atoms, making it readily feasible to generate molecules that exist as discrete entities in solid, liquid, and gas phases. While many inorganic systems (organometallic coordination complexes, metal clusters) are known that exist as individual molecules, the field of inorganic chemistry is dominated by efforts to synthesize solid-state materials, where delocalized bonding, higher coordination numbers, and electron-deficient atoms lead to the formation of extended systems with more delocalized electronic manifolds. Organic synthesis is the foundation upon which virtually all major areas of synthetic chemistry are based, including polymer chemistry, natural products synthesis, molecular building block chemistry for the self-assembly of macromolecules in supramolecular chemistry, and molecular electronics. Among these areas, the field of natural products chemistry is particularly significant as a field of synthetic investigation, where efforts are made using the knowledge of synthetic chemistry to generate the highly complex molecules produced by the chemical machinery of living organisms. The distinction between natural products

chemistry and biochemistry is pronounced, as the two methods employ very different routes (in biochemistry, the machinery and raw materials of the chemically rich and highly active cell; in natural products chemistry, the highly controlled and unidirectional chemical environments of macroscale reaction vessels) to the formation of the same molecules.

## Synthetic Chemistry and Biochemistry

Synthetic chemistry and biochemistry differ at many levels, the most fundamental being the range of systems capable of performing synthetic operations. Synthetic chemistry is performed by optimization of the entire chemical environment, with the goal being the unidirectional synthesis of any type of molecule. With the focus on the final product of a chemical reaction, the environment is optimized for specific reactions, removing the statistical complexity of side reactions and otherwise unknown chemistry in the interest of optimizing chemical yield. In biology, by stark contrast, many of the same basic chemical motifs occur that are used in numerous types of chemical reactions and, importantly, the raw materials used to fabricate the molecular machinery of life share structural commonalities that the same fabrication machinery can use to make functional, highly complex molecules. The vast flexibility of chemical reactivity and functionality that exists in living organisms belies the very small set of molecular building blocks that are combined to achieve this great flexibility. With the molecular machinery available from the synthesis of simple building blocks into structurally complex enzymes, the broader palette of biochemical synthesis becomes available to generate far more complicated molecules, such as the bio-active chemicals that become the focus of natural products synthesis for new pharmaceuticals. Synthetic chemistry extends the range of natural molecular assembly far beyond what the environments and chemical conditions of living organisms would otherwise allow, either through the use of otherwise inaccessible chemical environments or the production of non-biological raw materials for assembly.

## The Synthetic Reaction Cycle And Overall Process

All progress in synthetic chemistry is driven by the development of new chemical reactions. Discovering and detailing the results of new phenomena and reaction pathways as part of synthetic chemical studies extends the range of chemical manipulation available to all researchers and all disciplines reliant on the generation of new molecules. The general procedures for developing new



products and reaction pathways are described briefly below to introduce the stages at which specific future developments in synthetic chemistry can be expected to take place (see below).

### *Reaction Pathway*

As part of basic research, the route to new products or the development of new reaction schemes begins with the identification of novel chemical reactions or processes. As there exists great difficulty in monitoring chemical processes to discover new reaction pathways or product formation, the identification of new pathways begins with the identification of new products from chemical reactions.

### *Separation/Purification*

Chemical product isolation from reaction mixtures is necessary for many forms of chemical analysis and for multi-step chemical reactions that employ different reaction conditions with each new intermediate. The reduction in laboratory effort required for isolating intermediates or products is the driving force behind reaction optimization, an area of considerable research interest as part of industrial efforts for large-scale, highly complex chemical syntheses and environmentally-conscious, "Green Chemistry" efforts.

### *Optimization*

The optimization of a reaction pathway or chemical process can come in many forms once the reaction in question has been identified and the product has been characterized. When the family of reactants and product belongs to a known class of chemical reactions, the extensive library of chemical precedent can be used to both categorize the nature of the chemical reaction and, where such studied within the family exist, optimize the reaction pathway by modification of reaction conditions (solvent, temperature, time, etc.). The discovery of a new reaction pathway can be understood, then optimized, based on numerous approaches, including combinatorial (Edisonian) studies on slightly altered reactants, straightforward changes to the environmental conditions (including altering solvent choice within a similar range of properties, changing the temperature of the system) and computational studies to identify plausible transition state structures against which to test new types of chemical reactants.

### *Reaction Mechanism*

The ultimate goal of a fundamental synthetic chemistry experiment is the identification of a reaction mechanism, a description of a reaction process that combines the knowledge of the reactants, the structure of the final product, and an understanding of the possible changes to the reactants due to environmental conditions, the presence of catalyst,

etc., that serves as a guide to developing and optimizing other, similar types of chemical reactions, by which the library of known synthetic chemistry is rationally extended.

## **Chemical Reactions And External Control**

Synthetic chemistry is a highly developed set of tools and methodologies for performing atomic and molecular manipulation on quantities of reactants using macroscale techniques. There are many reasons for this, including the relative research ease of performing larger-scale chemical reactions and handling the products for either use of purification, the usual need for specific quantities of product and not just individual quantities for nanoscale-specific application, and the greater control over environmental conditions for chemical reactions that come from larger scales. This macroscale control of chemical phenomena extends far beyond simply defining a chemical environment (the flasks, solvents, and temperature). The preparation of reactants, the modification of reactants to direct specific reactions otherwise disfavored due to the different reactivity of the constituent atoms, the selection of catalysts to promote specific reactions, the separation of products for subsequent reactions, and numerous other aspects of a chemical synthesis are defined by the researcher at a scale orders of magnitude larger than the individual reactions. This near-absolute control over all aspects of a chemical reaction involving atomic phenomena is the true power of synthetic chemistry. To that end, synthetic chemistry is, above all else, a library of methods and mechanisms that enable the manipulation of atoms and molecules to create new products.

The standard methods by which a chemical reaction or series of reactions can be controlled under standard environmental conditions to generate a specific product are considered below.

### *Choice of Reactants*

As a knowledge base, the methodologies and techniques of chemical synthesis enable the generation of a product from a wide variety of different starting materials. While only a single reaction scheme for the total synthesis of a molecule may exist in the literature, the actual number of possible paths from raw materials to finished product is considerable given the broad understanding of reaction mechanisms and pathways to modify intermediate structures. The pathway from reactants to products must consider all aspects of a synthesis, including the yields at individual steps, the stability of intermediates to environmental conditions or even other intermediates, and the ease of separation of intermediates during a total synthesis. Ultimately, the covalent framework of each reactant defines the range of possible synthetic procedures. With the goal of



any synthesis being a specific product, the success and efficiency of all chemical syntheses comes from first from the selection of reactants and ideal intermediates.

### *Protecting Groups*

While sequences of chemical reactions may exist that straightforwardly step from reactant to intermediate to product, the restrictions in reaction pathway design that can come from the environmental limitations of specific chemical reactions themselves occasionally require modifying the covalent framework of a molecule to make potentially reactive areas inaccessible to reaction conditions and newly introduced reactants. As part of the synthetic design process, specific steps can be introduced that perform site-specific chemical modifications to chemical intermediates in order to limit or remove entirely their potential reactivity. The most common, and least invasive change to the covalent framework of a molecule is the addition of protecting groups, molecular fragments that bind to and can be removed from specific regions of an intermediate using mild reaction conditions.

### *Solvent*

The medium within which reactants are dissolved and allowed to interact is the most influential macroscale variable of any chemical reaction. The choice of solvent globally determines the degree of solubility of the reactants and, by that, the rate at which reactants combine to form products in a chemical reaction. The solvent can also have a profound impact in the reaction pathway itself by stabilizing intermediates or, in demonstrated examples, influencing the mechanism of a reaction, providing another macroscale control over the reaction process. In reaction design, the properties of the solvents (polarity, reactivity, solubility of reactants, protic vs. aprotic) are all important factors to consider, with most every chemical reaction requiring the identification of the solvent or solvent class as part of its incorporation into the vernacular of chemical synthesis.

### *Temperature*

The adjustment of the thermal conditions of a chemical environment is an important macroscale tool for controlling the rates of reactions. Within the range of temperatures at which reactants are stable, solvents remain liquid, and a specific chemical reaction is provided the thermal energy to occur, temperature affects the rate of reactions by both increasing the energies associated with the collisions of chemical reactants and the number of collisions to happen per unit time. Thermal control is specifically important for chemical reactions that involve high-energy transition state barriers between reactants and products.

### *Photochemistry*

Photochemistry provides a level of control over a chemical reaction otherwise unavailable by all other methods by making accessible physical states of reactants that can undergo chemical reactions. This level of control comes not from the stochastic environment of the reaction mixture, but the electronic structure of the reactants themselves. Optical excitation by narrow wavelengths can be used to overcome activation energies of specific chemical reactions that would only be fractionally overcome in thermal baths. Further, optical excitation in the ultraviolet and visible regions (those that directly affect the covalent bonds within molecules, the focus of chemical manipulation in this section) leads to changes in the symmetry of the electronic configuration of the reactants, making accessible reaction pathways otherwise forbidden by selection rules.

### *Catalysis*

Catalysts are molecules that accelerate the rates of chemical reactions without themselves being destroyed as part of the chemical reaction. Catalysts work by reducing the activation barrier of chemical reactions by stabilizing intermediates prior to chemical bond formation, reducing the energy of transition states between reactants, and/or positioning reactants in close proximity to increase the reaction rate by decreasing the separation. Catalysts are divided into homogeneous and heterogeneous catalysts. Homogeneous catalysts are those dissolved in the reaction medium, including organometallic complexes (species whose catalytic activity is founded in the ability of transition metals to coordinate multiple ligands, introducing both positional control over reactants and providing an orbital manifold within which bond breaking and structural arrangements can occur to direct new covalent bond formation) and, most recently, organocatalysts. Heterogeneous catalysts are those external to the reaction medium, including catalytic surfaces onto which components in a reaction medium can bind and undergo chemical transformations. Biocatalysts, or enzymes, act catalytically in the metabolic pathways of living organisms. They share similarities and differences to both pure homogeneous and heterogeneous catalysts as molecules that are dissolved in the cellular medium but catalyze reactions at the surface of the enzyme.

### **Molecular Changes In A Chemical Reaction**

The purpose of a chemical reaction is to either generate a new molecule from two or more starting materials or somehow modify an existing covalent framework at a specific location. Despite the complexities of organic synthesis and the large variety of approaches available to perform chemical modifications, the classification of these

possible modifications to the covalent framework of single molecules can be divided into just five types.

### *Addition*

The combination of multiple molecules to form a single product. This typically is limited to two reactants in a single chemical reaction that may progress sequentially in a synthesis.

### *Elimination*

The removal of atoms or molecular fragments from a single molecule without subsequent addition. In order to complete the valences of the affected atoms, either multiple-bond formation (between two adjacent atoms) or ring formation (two atoms separated by valence-filled molecular fragments) occurs. When the elimination occurs on the same atom, a highly reactive species is formed (such as a carbene).

### *Rearrangement*

A molecule is converted to a structural isomer (same number of atoms, different covalent arrangement) by way of changes to the covalent framework. These types of chemical changes can also be referred to as unimolecular or intramolecular reactions.

### *Substitution*

The replacement or displacement of an atom or molecular fragment by another atom or fragment.

### *Oxidation-Reduction*

Electron transfer reactions, or changes in oxidation number, which can promote the other changes to molecules outlined above.

## **Types of Chemical Reactions**

These classifications are used to describe how chemical reactions are performed and how they progress. While reaction conditions may be ascribed to them, these reaction types are meant only to describe the general processes by which reactants become products.

### *Single-Step and Combination Reactions*

These reactions are the most commonly employed in chemical synthesis, where two or more reactants are combined to form a product in a single step. Such reactions are important both for simple preparations of materials and for the modification of certain molecules used as reactants in subsequent chemical reactions.

### *Concerted Reactions*

In a concerted reaction, all of the changes to the covalent framework of a molecule occur in a single step that involves a transition structure between reactant and product but no isolatable chemical intermediate.

### *Cascade (Tandem) Reactions*

Cascade reactions occur as a sequence of intramolecular reactions with the product of each individual reaction existing as a high-energy reactant for the next reaction. These reactions differ from polymerization chemistry by their intramolecular origin, but share the common progression of reactivity until no chemical intermediate to a subsequent reaction is available.

### *Multi-Component Reactions*

This is a general category for describing chemical reactions where three or more reactants form a single product. This category includes cases where three components combine at once to form a product or, as is more common in the stochastic environment of a reaction vessel, where three or more reactants combine via numerous bimolecular reactions.

### *One-Pot Synthesis*

A synthesis where all reactants are placed into a single chemical environment and the formation of a product occurs with no other external influences. Such syntheses are of high methodological regard in the synthetic chemistry community, as issues of purification, high-energy intermediate trapping, intermediate and potentially low-yield steps, and waste generation are obviated.

### *Telescopic Synthesis*

A special class of one-pot synthesis where reactants are added step-wise to the reaction mixture but still without isolation of intermediates, providing a level of sequential control to the modification of single molecules or the growth of incrementally larger ones.

### *Semisynthesis*

A semisynthesis is one that utilizes the covalent framework of a natural product (a molecule obtained from a living organism) as the foundation for subsequent chemical modification, either to alter the natural product (such as a functionalization of a bio-active molecule) or to use the natural product as a component for a larger chemical structure. Semisynthetic methods are widely used in the pharmaceutical industry as a means to removing the considerable chemical difficulty of synthesizing the highly

complex molecules that biological systems generate as part of life processes.

### *Solid-Phase Synthesis*

While often considered as a separate class of chemical reaction to conventional synthetic chemistry, solid-phase chemistry shares many similarities. A solid-phase synthesis is one in which a molecule is built from an initial fragment mounted into a solid surface, often a functionalized bead of macroscale size. Such approaches are ideal for the synthesis of long-chain molecules, such as peptides, specialized organic polymers, and DNA strands, as each step in the reaction can be highly controlled. The molecular fragments or reactants on the beads, isolated in a reaction vessel or within a column, can have different chemical environments and reactants continuously added to or washed by them. Such approaches also allow for performing unique chemical modifications to the synthesized molecules by way of the addition of protecting groups to otherwise reactive molecular fragments.

### *Asymmetric (Chiral, Stereoselective) Synthesis*

Asymmetric synthesis is a special classification of chemical reactions that yield chiral products, molecules with non-superimposable mirror images (molecules with “handedness”). The importance of single enantiomers (one chiral form of a molecule. In “handedness” terminology, isolating the left handed products instead of right or vice versa) and their generation in a chemical synthesis has its greatest significance in natural products chemistry and biochemistry. The building blocks of all molecular machinery in biology (amino acids) are inherently chiral (L-form), as are the sugars used by living organisms (D-form). The activity of most every pharmaceutical is highly dependent on the chirality of the molecule, as are molecules (ligands) involved in protein binding.

### *Total Synthesis*

The total synthesis of a molecule is the complete, step-by-step procedure by which a single product is formed from reactants, often starting from very simple chemical reactants and proceeding sequentially by way of varied chemical manipulations. A total synthesis will occur by way of the implementation of known reaction pathways in the conversion from reactants to products. The progress towards developing a total synthesis of a molecule may include the identification and optimization of new chemistry.

### *Future Directions*

Synthetic chemistry is the dominant science of atomic manipulation, but is still largely controlled at the

macroscale, the scale at which researchers can easily generate chemical environments and manipulate reaction conditions. As relevant to the aims of productive nanosystems, it is obvious that the understanding of chemical reactions and predictability of mechanisms for developing successful chemical syntheses is vital. As systems designed to produce new materials and devices within several orders of magnitude of the atomic building blocks themselves, the reduction of the chemical environment to the nanoscale for application by productive nanosystems is the key point of inquiry that separates productive nanosystems, systems that may be able to control the chemical environment or, perhaps, generate the appropriate chemical environment as part of a larger process, from the continued macroscale effort to perform chemical synthesis at any scale. Future directions in chemical synthesis relevant to the aims and scope of productive nanosystems are considered below.

### *Catalysis*

Catalysts are capable of making inaccessible reactions possible at the scale of the reactants themselves, an important design consideration in the development of nanoscale systems for performing synthetic operations on molecules. The field of catalysis development is driven at all levels of chemical synthesis, from fundamental mechanistic studies to large-scale industrial production. New catalyst development is being performed both by experimental and computational efforts. The class of catalysts known as organocatalysts has received new attention in the development of synthetic chemistry. These organic catalysts are species that do not employ transition metals but instead rely on the staple atoms of organic synthesis (C, N, O, H, S), making them both significant contributions to “Green Chemistry” development and the development of novel chiral catalysts for asymmetric synthesis. The development of new catalysts not only encompasses those that increase reaction rates for known reactions, but also those with improved longevity over the course of many chemical operations. [Ref. 1]

### *Nanoscale Chemistry*

At the forefront of chemical synthesis of significant interest to nanoscale applications and productive nanosystems is the use of encapsulating molecules for the isolation of individual reactants to form single products within molecular containers whose properties can be altered by chemical modification. The formation of nano-environments for use as containers for performing chemical operations have been demonstrated in dendrimer, coordination complexes, and molecular capsules, or cavitands. The possibilities for absolute control over the direction of a chemical reaction and the formation of specific, highly localized products have only begun to be

explored, but are key contributions to the general understanding of mechanisms by which productive nanosystems may enable the mass production of atomically-precise, highly controllable materials for a multitude of applications. [Ref. 2, 3]

### *Methodology*

As a tool for the synthesis of any possible molecule, macromolecule, or nanostructure, an important goal of synthetic chemistry is the cataloguing of all possible reactions and mechanisms from which any synthetic operation becomes possible. The goal of a complete synthetic knowledge base is not only to provide routes to the synthesis of available molecules and common chemical motifs but to provide insights into new classes of chemical reactions as new molecular motifs are envisioned whose syntheses do not appear to conform to known reaction pathways in part or, less likely, as a whole.

### *Efficiency and Economy of Synthesis*

The optimization of any synthetic pathway to a final product includes reducing the number of reaction steps, the minimization/removal of side products, the maximization of used reactants, the minimization of reaction times, and the minimization of energy used in the reaction process, all aspects as important to chemical laboratories as they are to environmentalists. The complete optimization of synthetic processes for the production of materials used in bulk or at the nanoscale is dependent on the elucidation of all aspects of the synthetic process, one that combines efforts by mechanistic chemistry, computational chemistry, chemical engineering, and fundamental synthetic research. [Ref. 4]

### *Theoretical Insights for Next Generation Synthesis*

The understanding of reaction pathways, transition state structures, relative stabilities of components and intermediates, solvent influences on reaction intermediates, and the role of catalysts in accelerating chemical reactions are all aspects of synthetic chemistry that can be explored using computational quantum chemical methods. The use of theoretical studies for considering the mechanisms of chemical synthesis is highly interdisciplinary in nature, as theoretical models must be tested against experimental studies to determine the influence of reactants and reaction conditions and, most importantly, experimental chemists must make aware those chemical reactions important to new directions in chemical synthesis that require explanation beyond the combinatorial efforts of experimental mechanistic chemists.

## *Synthetic Chemistry And The Biomimetic Productive Nanosystem*

The living cell in biology is a highly complex system of raw materials, machinery, and finished products that exists in unison. In the absence of any biological description of the processes that occur, a cell is a chemical factory that employs very limited sets of fundamental building blocks and a remarkably small set of types of chemical reactions to produce the vast majority of the molecular machinery and cellular systems therein. The key to the success of the cell as a productive system is the conglomeration of machinery, raw materials, and chemical reactions that coexist seamlessly to perpetuate the system as a whole. The narrow range of significant chemical reactions, and the considerable cellular control over their occurrence by way of site-specific chemical reactions within the enzymatic molecular machinery, provides a model that a sufficiently well-developed synthetic knowledge base would enable the design and optimization of from specific classes of simple chemical reactants (raw materials), molecular catalysts (molecular machinery), and narrowly defined chemical reactions possible among the chemical functionalities of those simple reactants. Such an exquisitely designed system represents, as a long-term possibility in the development of productive nanosystems, an example of the most highly complex result of synthetic chemistry and most complete demonstration of our understanding of the properties and behavior of atoms and molecules.

#### References:

- [1] Gladysz. Pure Appl. Chem. 73 (2001) 1319.
- [2] Iwasawa, Hooley, Rebek. Science 317 (2007) 493.
- [3] Tomalia, Henderson, Diallo. Dendrimers – an Enabling Synthetic Science to Controlled Organic Nanostructures. Handbook of Nanoscience, Engineering, and Technology, 2<sup>nd</sup> Ed. (CRC Press) 2007.
- [4] Trost. Angew. Chem. Int. Ed. Engl. 34 (1995) 259.



## A Path to a Second Generation Nanotechnology

This document describes a pathway from where we are now to *productive nanosystems* that could create almost anything. This proposal depends on the development of *designed catalysts* that function the way that biological enzymes do but rather than being evolved by nature are rationally designed. This proposal does not propose to create or depend on the development of the general-purpose molecular manipulators or complex molecular computers that others have described as parts of advanced nanotechnology, although if we could achieve the aims of this proposal then we could use what we have learned to create designed catalysts that would build all of those things. The final aim of this proposal is a *machine solution*, a concentrated liquid solution containing a collection of a few hundred or thousand *designed catalysts* that resembles the crowded cytoplasm of a cell. The *machine solution* will not contain anything like DNA, rather all control and feedback will be provided by a desktop computer through an interface that uses electrical impulses and redox chemistry to activate the *designed catalysts* floating in the *machine solution*. An advanced version of the *machine solution* would be able to create copies of every *designed catalyst* within itself from raw materials that are simply poured into it and then operated on by a computer program running in a desktop computer and controlled through an electrode grid placed within the *machine solution*. A human operator could then design new *designed catalysts*, write software to instruct the *machine solution* to assemble them and then these new *designed catalysts* would synthesize the compounds or products that the human operation designed them to synthesize. With the proper programming the machine solution could synthesize desired products from small molecules that act as feed stocks to complex covalent structures that are hundreds of nanometers to thousands of nanometers across. Large, complex structures would be assembled from smaller structures with specific *designed catalysts* that recognize the connection points between the smaller structures and catalyze the linkage between them.

This roadmap requires that we develop the ability to rationally design catalysts and molecular recognition to achieve this second generation nanotechnology. Biology uses catalysis and molecular recognition as the most fundamental tool in assembling everything in Nature; everything from the smallest virus to the largest blue whale. If we can master catalysis and molecular recognition then we could build anything we desire.

In this proposal I have made extensive use of cartoons and figures to illustrate concepts. Every part in every figure has a real molecular analogue, although the precise details of the building block structures and oligomer sequences and structures remain to be developed along the road map.

### Specific Aims

- (1) We will develop a molecular building block technology that is easier to design with than natural amino-acid/protein technology and that contains more diverse chemical functionality. This new molecular building block technology will be based on cyclic monomers that are coupled through pairs of bonds to create well-defined three-dimensional shapes and rely much less on a complex folding process.
- (2) We will use this new molecular building block to develop *designed catalysts*.
- (3) We will create a collection of *designed catalysts* that together will form a *machine solution*.

### Where We Are Now: Bis-peptides

My laboratory has developed a systematic approach to shape-programmable molecules that we call bis-peptides. Our approach involves the chemical synthesis of unnatural cyclic amino acids that we attach to each other through pairs of bonds to create rigid ladder molecules with designed shapes. We are developing building blocks that carry an additional functional group like natural amino acids do. Our goal is to develop large molecules that are as complex and capable as biological proteins. In particular, our goal is to use them to develop a systematic approach to the rational design of catalysts and complex molecular recognition.

### Published Monomers

Monomers are synthesized in a fully protected form and the protective groups are removed during oligomer assembly.

Figure 1 shows a two-dimensional cartoon of a monomer below alongside the chemical structure. The rigid core of the monomer is represented by the filled triangle. The two protected alpha-amino acids are represented by the two pairs of red and blue sticks that protrude from the filled triangle. The blue sticks represent the two amines and the two red sticks represent the carboxylic acid and ester groups of a building block. The black shapes attached to the red and blue sticks represent protective groups.

The monomers that we have developed syntheses for and have published are in Figure 2.



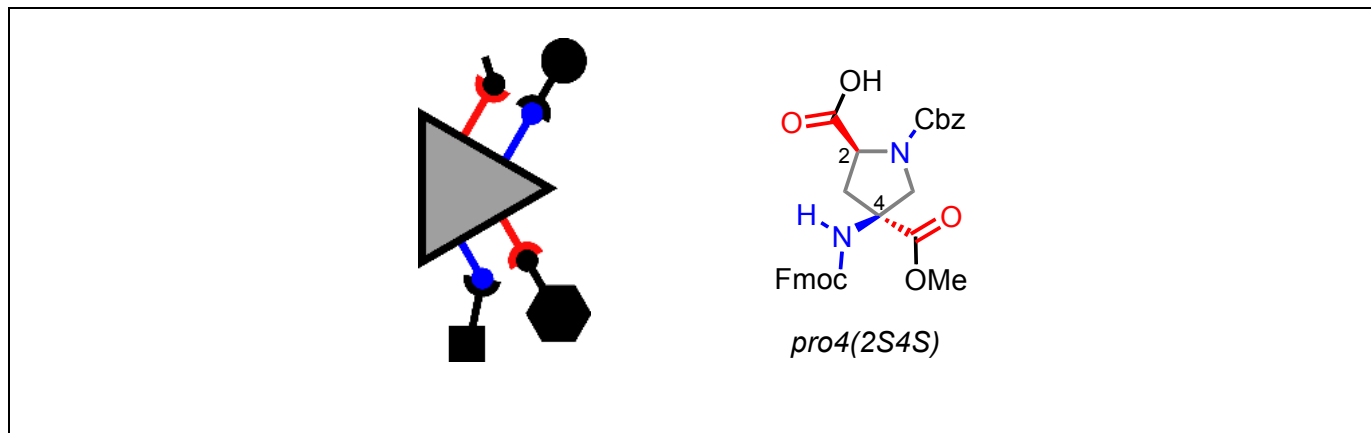

**Figure 1. Monomer synthesis using protective groups that are removed during oligomer assembly.**

**Left: A cartoon representation of a molecular building block. Right: The chemical structure of the first molecular building block “*pro4(2S4S)*”.**

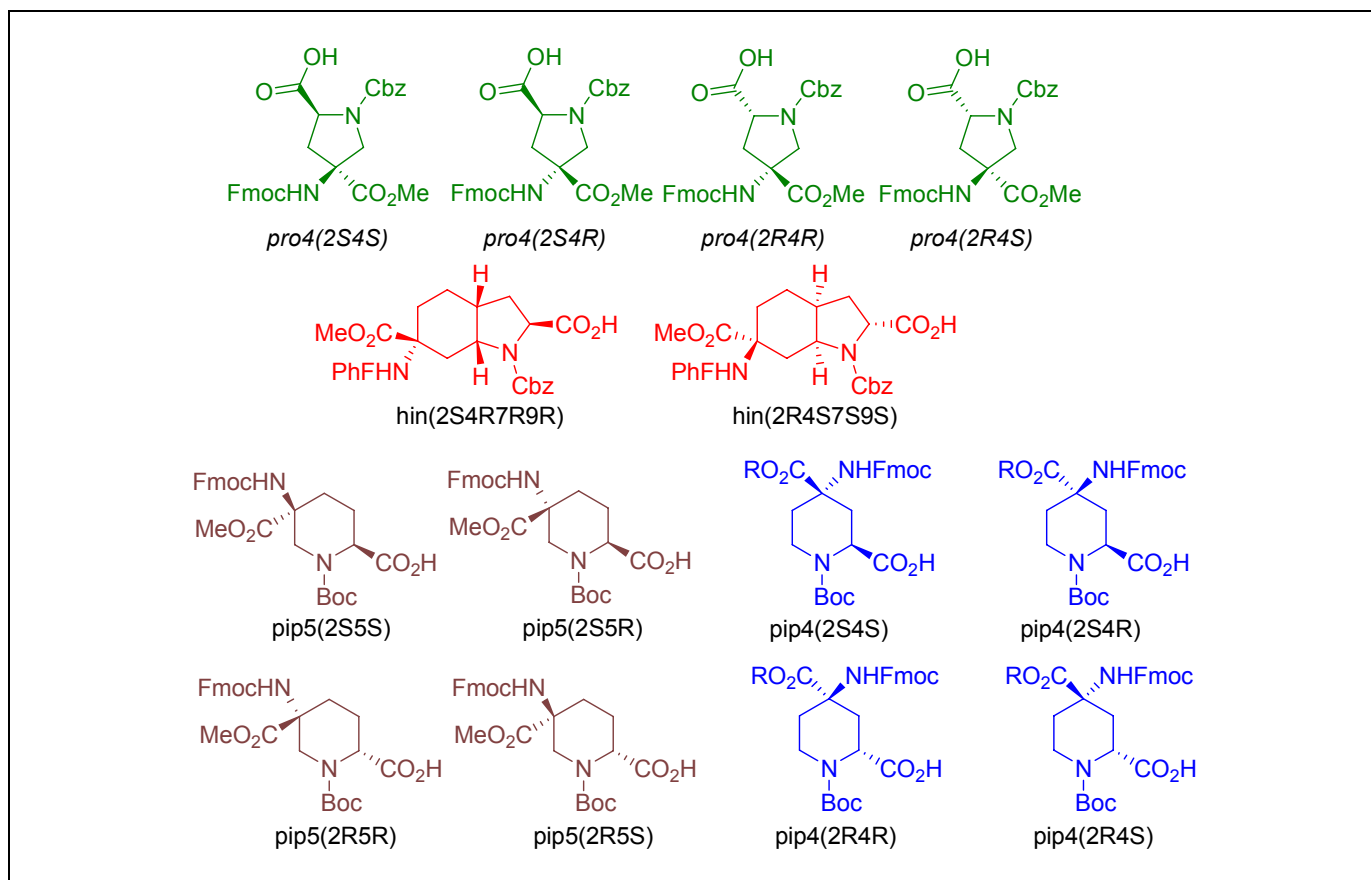

**Figure 2. Structures of published and unpublished bis-amino acid building blocks.**

## Oligomer Assembly

Oligomer assembly is carried out in two stages; an assembly stage and a rigidification stage (Figure 3, Figure 4).

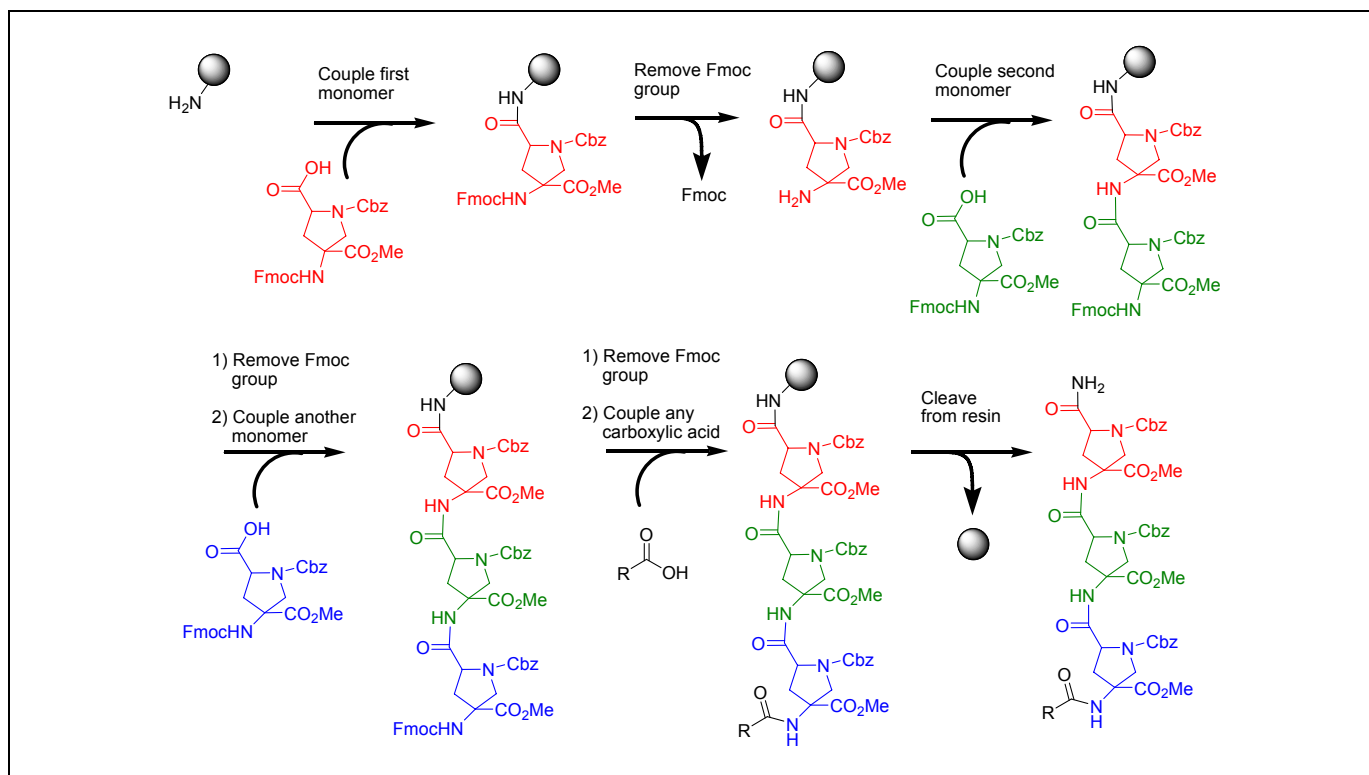

**Figure 3.** Bis peptide assembly uses standard solid phase peptide synthesis methodology.

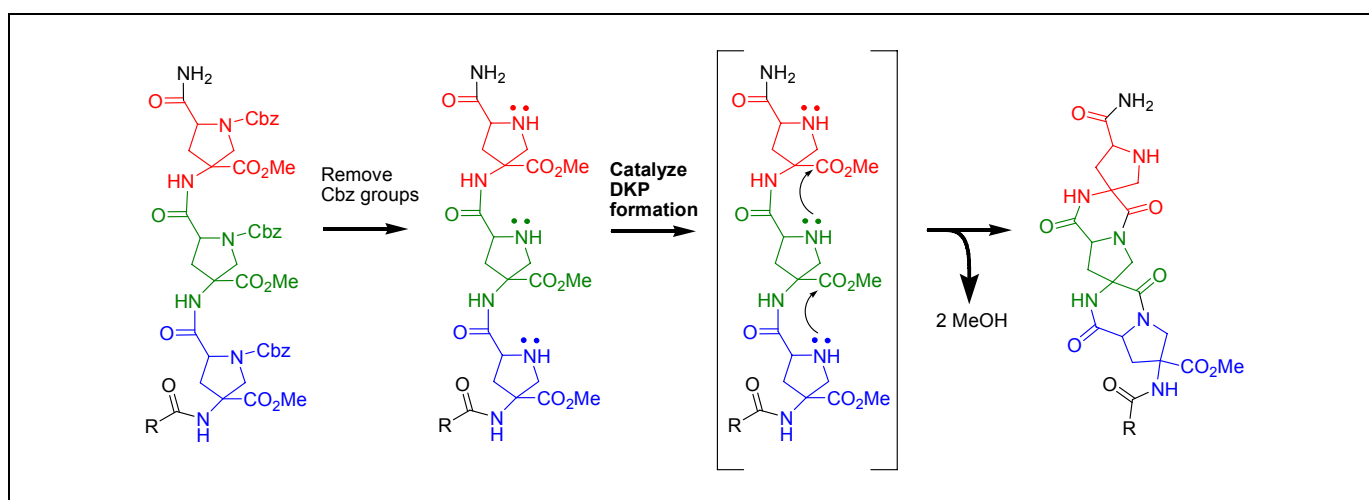
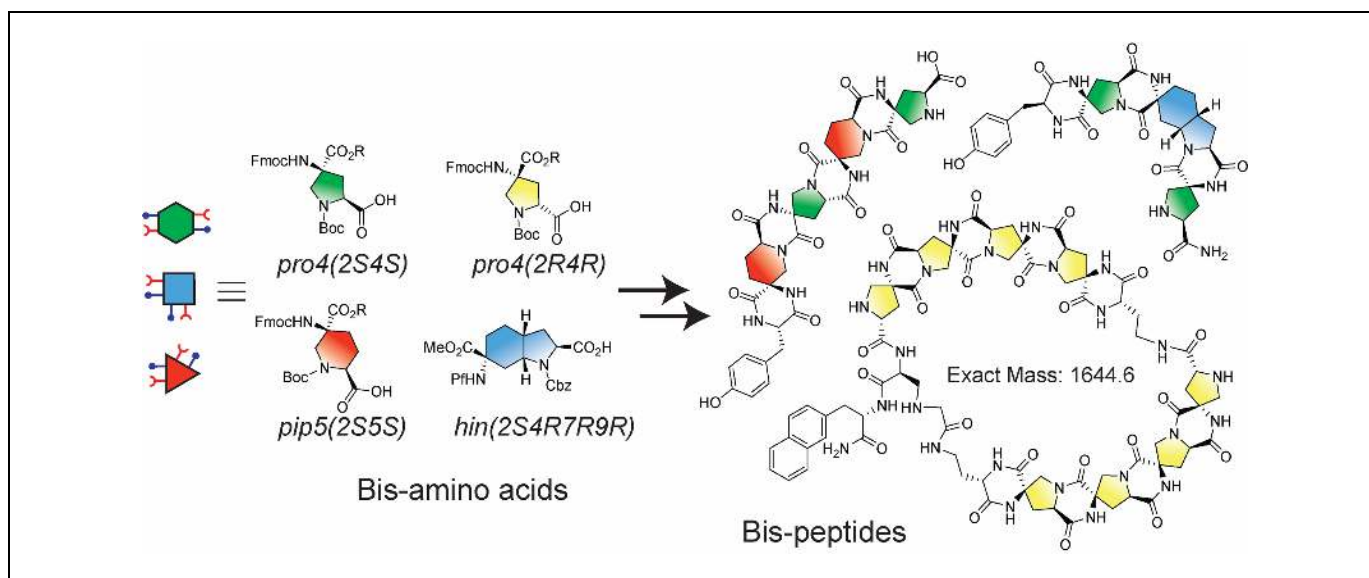

**Figure 4.** Bis peptides are rigidified by a catalyzed intramolecular diketopiperazine formation reaction.

The reaction closes a second amide bond between each bis-amino acid monomer. The result is an oligomer that has no rotatable bonds within its core structure and its shape is determined by the structure, sequence and stereochemistry of its building blocks.

## Example Oligomers

Some short oligomers that we have synthesized are shown below (Figure 5).



**Figure 5. Bis-amino acids are coupled through pairs of bonds to create bis-peptides.**

**We have synthesized several dozen small bis-peptides. The three example bis-peptides on the right have all been synthesized.**

## Structural Characterization

Bis-peptides can be characterized using the same experimental techniques that have been developed for small molecules and proteins. Bis-peptide structures can be determined using nuclear magnetic resonance techniques and X-ray crystallography.

## A First Generation Nanotechnology Based on Bis-peptides

### Functionalized Building Blocks

We are currently developing the first synthesis of functionalized molecular building block that carries a functional group like the side chain of an amino acid. We are developing a general synthesis that could be used to create a large variety of functionalized building blocks with more diverse chemical functionality than found in proteins.

### Anchoring Building Blocks

Anchoring building blocks are pairs of building blocks that will carry complementary function groups that when held together in the proper orientation will undergo a chemical reaction and irreversibly lock the building blocks together. One building block is functionalized with one of the groups and another building block is functionalized with the other.

Groups must be chosen that are relatively stable groups independently and when they are brought in close proximity they will react at a reasonable rate. One possible pair of anchoring groups consists of an alkyne and an azide which undergo a Huisgens 2+3 cycloaddition when brought together. Another possible pair consists of a diene and a dienophile which will undergo a Diels-Alder reaction when brought together (Figure 6).

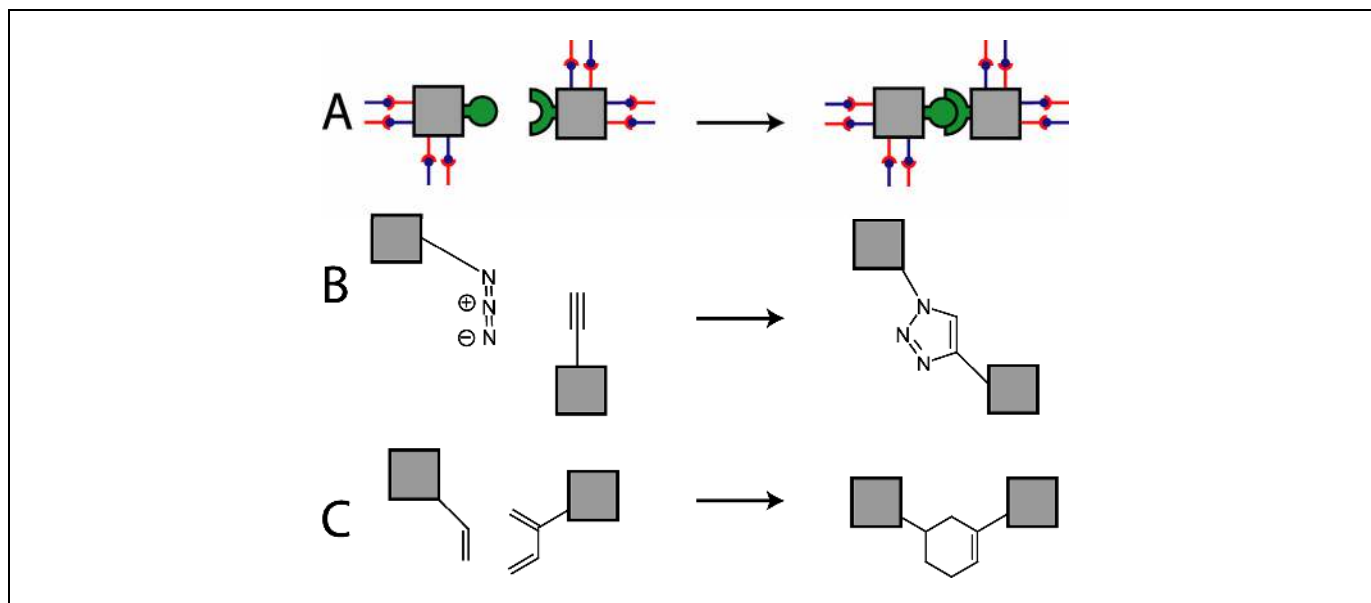

**Figure 6.** A cartoon representation of a possible building block pair undergoing a Diels-Alder reaction.

(A) Two building blocks (left), each functionalized with a group that reacts with the other, form a covalent linkage (right). When the building blocks are held together in the proper orientation they will react and form the covalent linkage. (B) One implementation would use an azide and an alkyne as the reactive pair. When they are held together in an appropriate way they form a triazole. (C) Another implementation would be to use a diene and a dienophile. When held together in an appropriate way, they will undergo a Diels-Alder reaction. The reactivity of the diene and dienophile can be tuned to enhance the reaction rate.

### *Tethering Building Blocks*

Tethering building blocks would be functionalized building blocks that can undergo reversible covalent attachment. An example would be a building block that contains a thiol group; two of these could form a disulphide bond. Another example would be a building block that carries a hydrazine and another that carries a ketone or aldehyde; together these could form hydrazones. These groups would be useful to reversibly lock two oligomers together so that they could further react through anchoring groups.

### **Developing Designed Catalysts and Molecular Recognition**

A catalyst is a molecule that accelerates a specific chemical reaction without being consumed or changed by the reaction. Many chemical reactions are so slow at room temperature that they essentially do not take place.

Biological catalysts (enzymes) can accelerate reactions by many orders of magnitude over the background reaction. All molecules that are made in nature are made by catalysts.

Molecular recognition is the ability of one molecule to select and bind another molecule through non-covalent interactions. This is the most difficult problem to solve. Nature is replete with examples of molecular recognition and catalysis; human attempts at designing artificial biomimetic catalysts and molecular recognition are at a very primitive stage when compared to nature. Designing molecular recognition and catalysts will require sophisticated computer-aided design and macromolecule synthesis capabilities. Based on recent demonstrations of designed protein-based catalysts and protein binders by Homme Hellinga's group at Duke University, David Baker's group at the University of Washington, and others, I am convinced that computers and modeling have advanced to the stage where we can rationally design molecular recognition and catalysts. Bis-peptides may offer a faster route to synthesizing macromolecules in which we can control where almost every atom goes in three-dimensional space.

The development of designed catalysts will require the synthesis of specific macromolecules that are between 5,000 and 100,000 Daltons in size. Designed catalysts will need to be large enough to wrap around the small molecules or sites that they will operate on. Designed catalysts need to be large enough to position several chemically reactive functional groups in three-dimensional space in order to catalyze a chemical reaction. Solid phase synthesis can access the low end of this range (5,000 to 10,000 Daltons) and other methods will need to be developed in order to couple oligomers together to create larger macromolecules. While we could use chemical ligation to couple oligomers together it would be valuable to be able to create multiple bonds between oligomers to create rigid, covalent networks because they will be easier to design with. Two plausible but untested ideas are presented below: “chemo-assembly” and “positional-assembly.”

### **Chemo-Assembly of Larger Structures**

“Chemo-assembly” describes a way to assemble larger structures made up of two to thirty bis-peptide modules that have been carefully designed with complementary tethering groups and anchoring groups displayed on their surfaces (Figure 7, Figure 8). Chemo-assembly mimics the solid phase synthesis of bis-peptide oligomers with bis-peptide modules acting as the building blocks. The modules that are connected to the solid support are called the “workpiece” and each module that is added is the “part”. As each part is added to the resin bound workpiece, it forms reversible bonds (see Tethering Building Blocks) with every tethering group on the workpiece. This requires an excess part to be added in order to drive the reactions to completion. The part that is correctly bound brings two complementary anchoring groups together which react and anchor the part to the workpiece. Then reducing agent is added to the resin and all parts that are not anchored are displaced. This may break the tether to the correctly attached part but it should be resistant to the reducing agent because now the anchor holds the tethering groups together. In any event, the tether will form once the reducing agent is removed. These steps are repeated for each part that needs to be added (Figure 8).



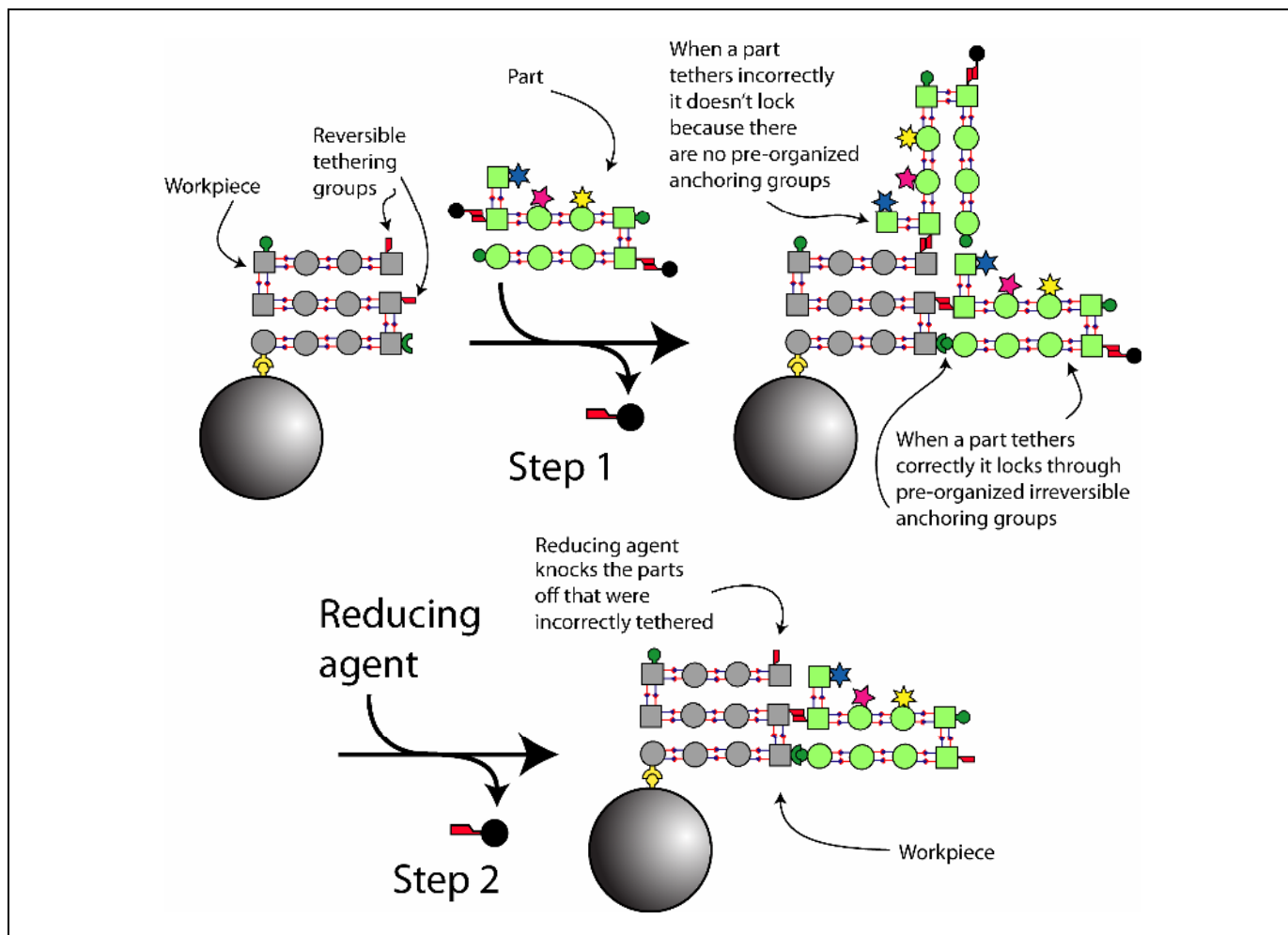

**Figure 7.** The first two steps of the “chemoassembly” of a large structure constructed from oligomeric parts.

(Stage 1) A part attached to a solid support presents two reversible thiol tethering groups. (Step 1) The second module is introduced with its thiols protected as disulphides. A problem that needs to be dealt with is that the module can connect to the correct thiol but through the wrong thiol on the incoming module; a solution may be to activate the thiol on the incoming module that we want to attach through is an S-sulfonate and the ones that we don't would be protected as a disulphides, the thiol/S-sulfonate should tether preferentially. The goal is to get the free module to tether through the correct thiol to the module on solid support. We want to avoid the competing reaction of disulphide bonding of the modules with themselves. The green modules that are properly tethered will react through pre-organized anchoring groups to anchor the modules together. (Step 2) Reducing agent is added and it knocks off any modules that are tethered but not anchored. Steps 1 and 2 can be repeated several times to drive the reaction to completion.

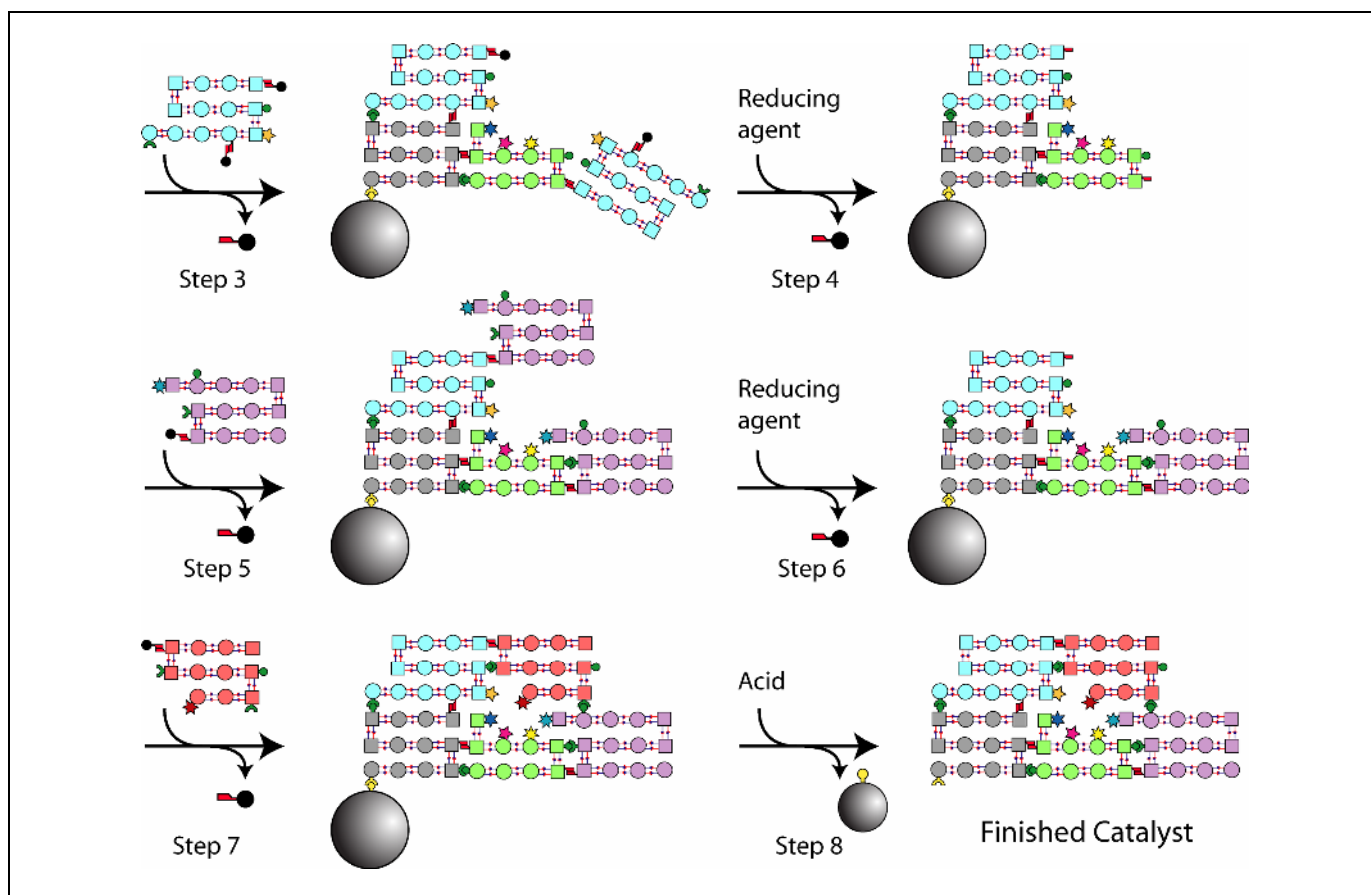

**Figure 8.** The rest of the steps for synthesizing a large structure from modules.

The result is a macromolecule constructed from several modules. Each module can contribute a few functional groups (starred groups).

## Positional Assembly of Nanostructures

Positional-assembly of covalent nanostructures constructed from bis-peptide oligomers is similar in spirit to the idea of “mechano-synthesis” proposed by Drexler and Merkle. It differs in that rather than building up structures an atom or small cluster of atoms at a time using highly reactive intermediates under ultra-high vacuum and low temperature, I propose to assemble 5,000 to 10,000 Dalton bis-peptide oligomers that have been designed to covalently attach to each other through anchoring groups.

“Positional-assembly” would be carried out at ambient temperature under aqueous conditions (Figure 9, Figure 10, Figure 11). Positional-assembly can only create one structure at a time for each probe tip. This would be useful for creating prototypes of designed catalysts that could be assembled in quantity using “chemo-assembly”. A few dozen copies of a designed catalyst prototype could be assembled on a surface and a very fine tube could be brought down on the prototypes and the solvent space above the catalysts sampled and analyzed using ultra-sensitive mass-spectrometry for traces of the desired catalytic products.

## Probe and Grippers

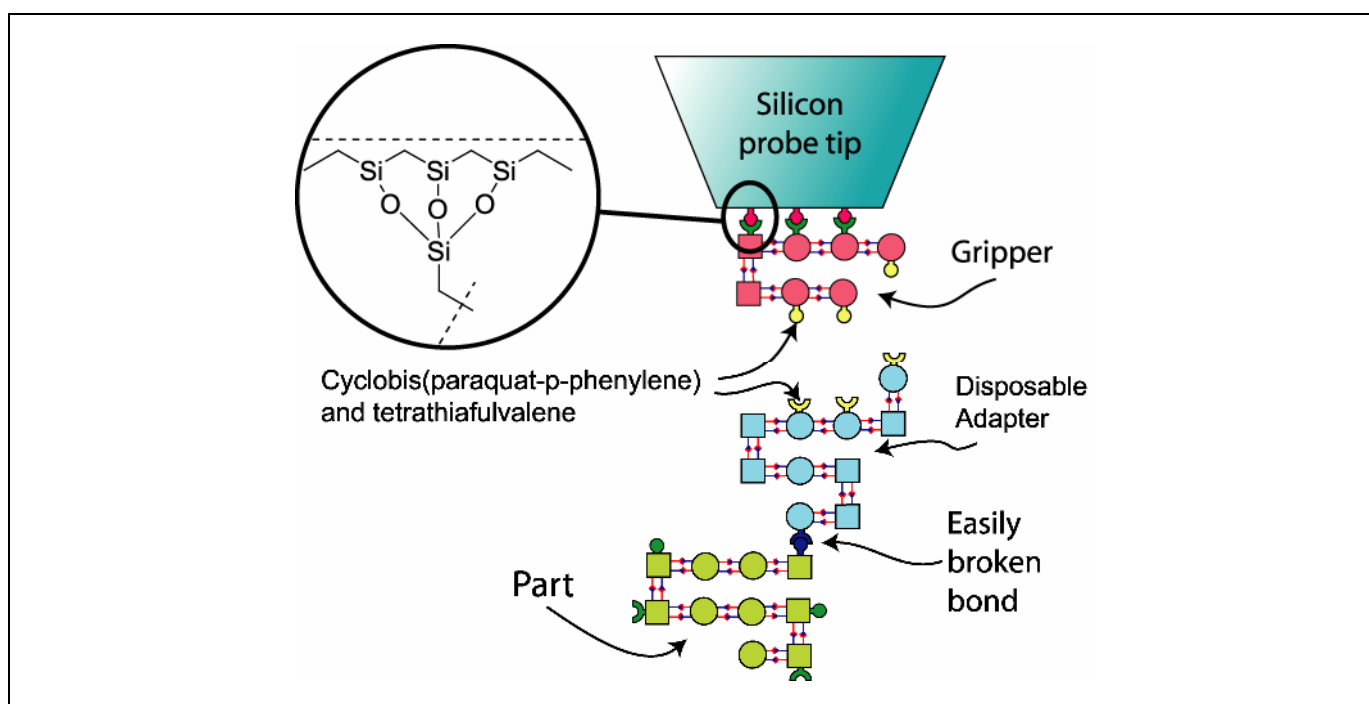

**Figure 9.** Illustration of the probe and gripper technique for positional assembly of nanostructures.

The tip of a probe tip is functionalized with a gripper tool that displays several groups (cyclobis(paraquat-p-phenylene)). The tip of the probe could be prepared using silicon depassivation and then covalent attachment through organosilane building blocks (inset circle). Each tip consists of a disposable adapter functionalized with several tetrathiafulvalene groups arranged to be complementary to the cyclobis(paraquat-p-phenylene) groups on the gripper. A part is attached to the disposable adapter through an “easily broken bond” such as an ester linkage.

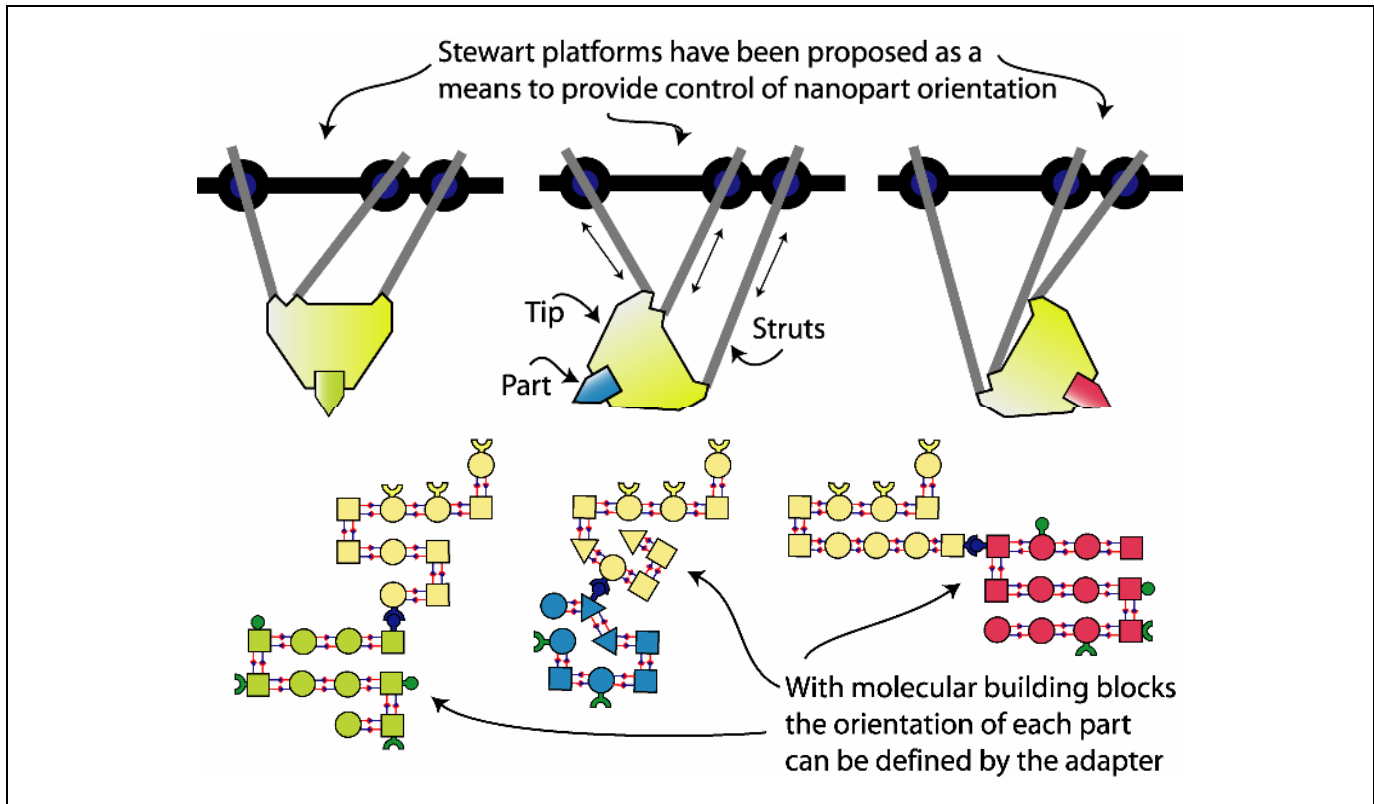
*Adapter/Tips*

**Figure 10. Illustration of the adapter/tip technique for positional assembly of nanostructures.**

In order to control the orientation of each new part, each adapter will be synthesized to hold its part in a designed orientation with control of all three orientation degrees of freedom, pitch, yaw and roll (illustrated on bottom). This avoids the need for a complex tool like a Stewart platform (illustrated on top) that controls the orientation of a tip by sliding struts in and out of a support structure. This simplifies the requirements of the probe tip and positioning hardware; only three positional degrees of freedom of the tip are required, two within the horizontal plane and one perpendicular to it.

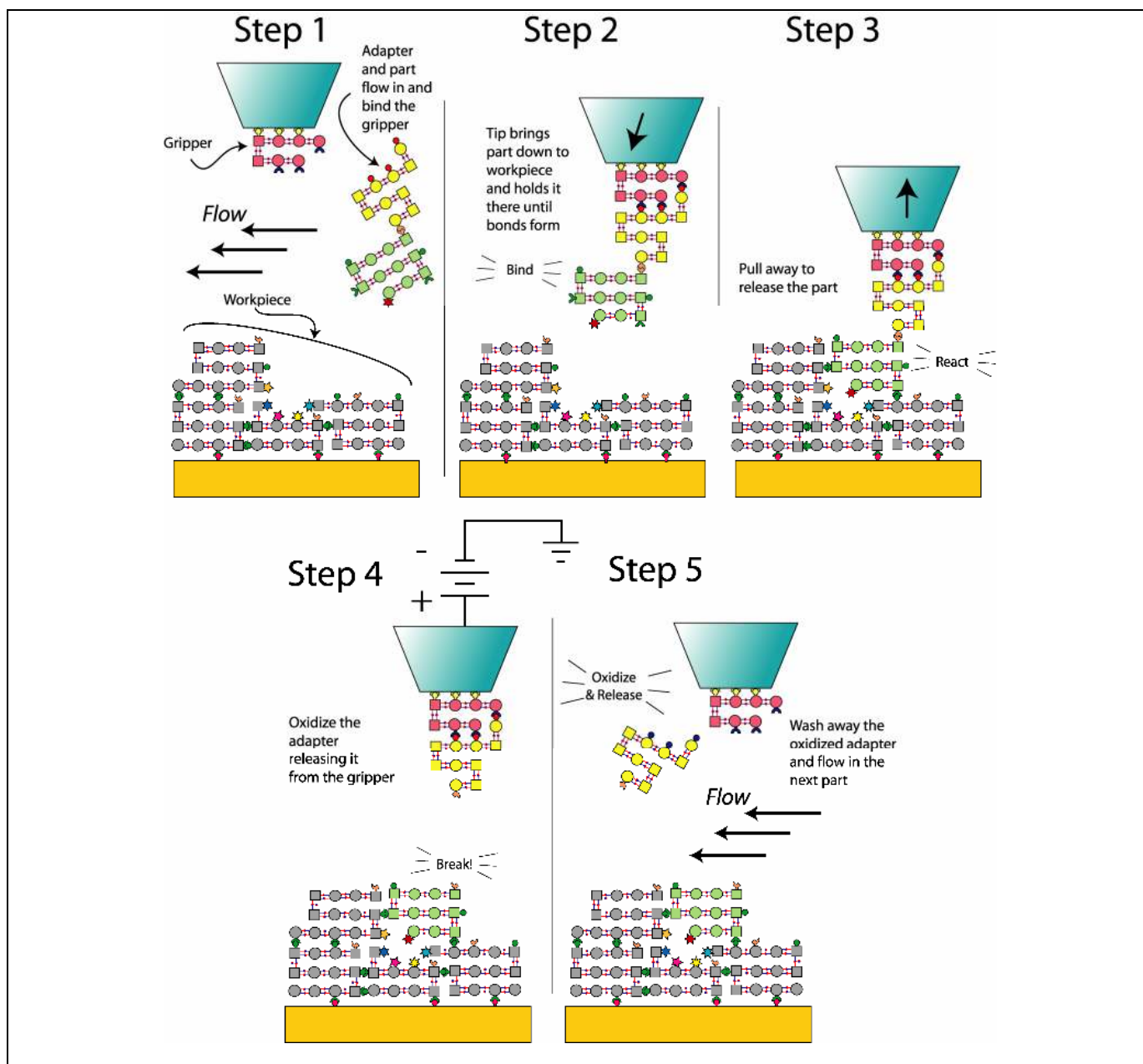
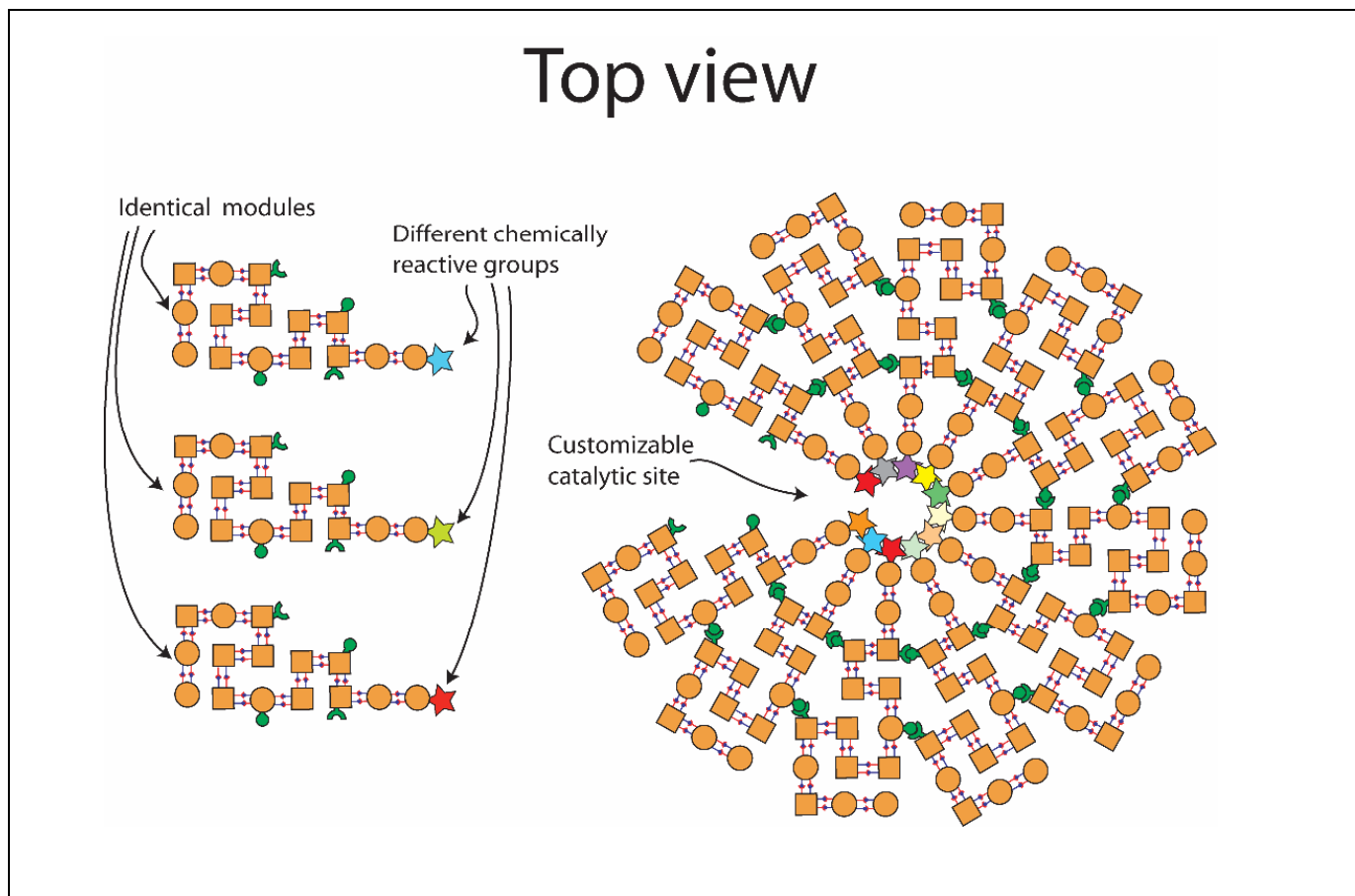

Figure 11. The steps involved in one cycle of positional synthesis of a nanoscale workpiece (grey).

(Step 1) A probe tip (yellow) with an attached gripper displaying a number of bluebox groups is functionalized with an adapter-part that flows in within a microfluidics channel. (Step 2) The probe tip with the attached part (green) is brought down to the work piece and held in place long enough for covalent bonds to form between the anchoring groups. (Step 3) The probe tip is pulled away and the weak bond (details aren't worked out here) between the adaptor (yellow) and the part (green) is broken with the help of the applied force. (Step 4) The probe tip is put under a positive potential, oxidizing the TTF groups on the adapter, releasing the adapter from gripper. (Step 5) The used adapter is washed away and another adapter/part flows in, go to step 1 and repeat.





**Figure 12.** This is an idea for creating configurable catalytic sites.

The figure shows three modules that are synthesized separately each carrying a different chemically reactive group on the tip. On the right is a ring of these modules with one module missing. By assembling the modules in different configurations, very different chemical environments could be created at the site in the center. These would be prototypes that would be assembled on a solid surface using positional assembly or they could be assembled using chemo-assembly. This idea was adapted from a suggestion by Eric Drexler.

## A Second Generation Nanotechnology Based on Shape Programmable Oligomers

This section describes an advanced nanotechnology that could create almost anything. It does not look like the robots, pumps, or rod-logic computers that others have described as advanced nanotechnology, although I think it could build all of those things. It bears a very close resemblance to the cytoplasm of a cell with no DNA and all control and feedback is provided by a desktop computer through an interface that converts electrical signals into activated catalysts. It describes a solution of nanomachines that given a drop of that solution, a vat of chemicals, a modern desktop computer, the interface electrode grid that is controlled by the computer and placed in contact with the solution, and a special computer program, will be able to

convert the vat of chemicals into a vat of this special solution. With the proper programming that vat of nanomachine solution could then build almost anything imaginable.

The goal here is to create an "artificial biology", an artificial analogue of an in vitro protein translation system made up of a bare-bones collection of nanomachines that can create copies of every nanomachine within it. The system consists of a stirred chamber filled with a solution of chemicals with an immersed control electrode containing many individually addressable electrodes carrying catalysts that can be switched on and off by changing the potential of

individual electrodes. All of the control and logic is on the outside, provided by a standard computer that drives every step of assembly through the electrode-mounted catalysts. Switching the electrode-mounted catalysts on causes them to switch specific header groups on, targeting the headers to specific nanomachines in the solution. The solution acts like a state machine, where the state is described by which headers are switched to specific states at any time. The state machine will be set into one state by external computer activation of a combination of electrodes on the chip that activate a set of headers in the solution. Those headers will then go to their targets where they will carry out their synthesis function, be deactivated and the system will then return to a resting state. The number of a particular header that is activated at any time is flexible and determined by how much current is supplied to the electrode and the diffusion rate of the headers to the electrode. The delay

between each activation will be determined by how long it takes for the solution to return to the resting state. This will determine how fast the system can be run, or how many synthetic operations can be performed per unit time. The solution will act like a data-flow programming language

### *Monomer Carriers*

Monomer carriers have triangular shapes, as shown in Figure 13; their bottoms are recognized by the stations of an assembler and their ends have reversible coupling groups that are used to assemble them into trains. Their tops have a unique recognition site and a position that can be charged with a specific building block by a carrier charger. Monomer carriers are analogues of transfer-RNAs; the difference is that carriers can be coupled together to make syntains.

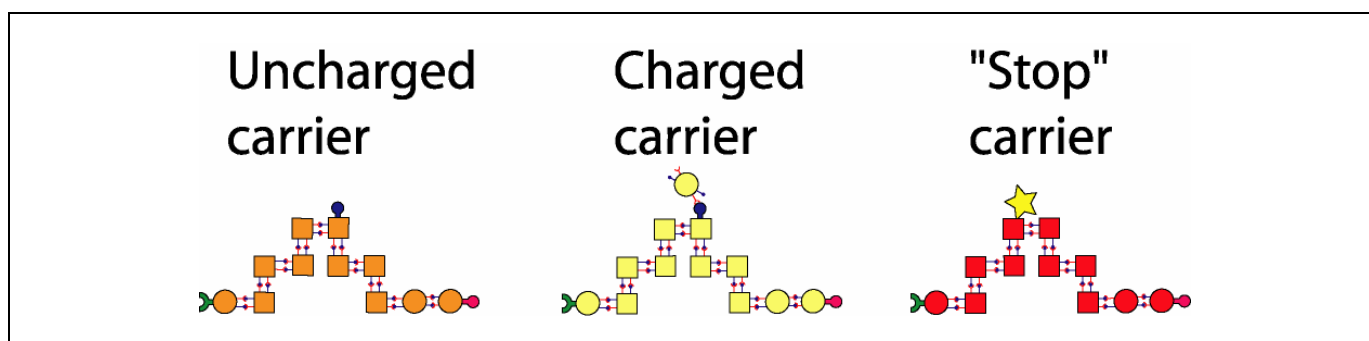

**Figure 13. Illustration of the different types of monomer carriers.**

**Carriers have a triangular shape and reversible coupling groups on their ends (hydroxyls and carboxylic acids or amines and carboxylic acids) that allows them to be assembled into trains like box-cars. They also have a special structure on their top surfaces that allows them to be specifically charged with a building block through an ester linkage. There is a special "Stop" carrier that doesn't carry a building block but will catalyze the cleavage of a new oligomer from the last syntain carrier.**

### *Carrier Chargers*

Carrier chargers are catalysts that activate and attach a building block to its specific carrier with high fidelity (Figure 14). They are responsible for the fidelity of oligomer synthesis. Error correction can be enhanced by creating catalysts that remove improperly attached building blocks to

the wrong carriers. There needs to be one of these for every building block/carrier combination. Carrier chargers are always on; as long as they have a supply of uncharged carriers, building blocks and activator, they will load building blocks onto carriers. They will load building blocks onto free carriers and onto carriers in syntains. Carrier chargers are analogues of aminoacyl-tRNA synthetases.

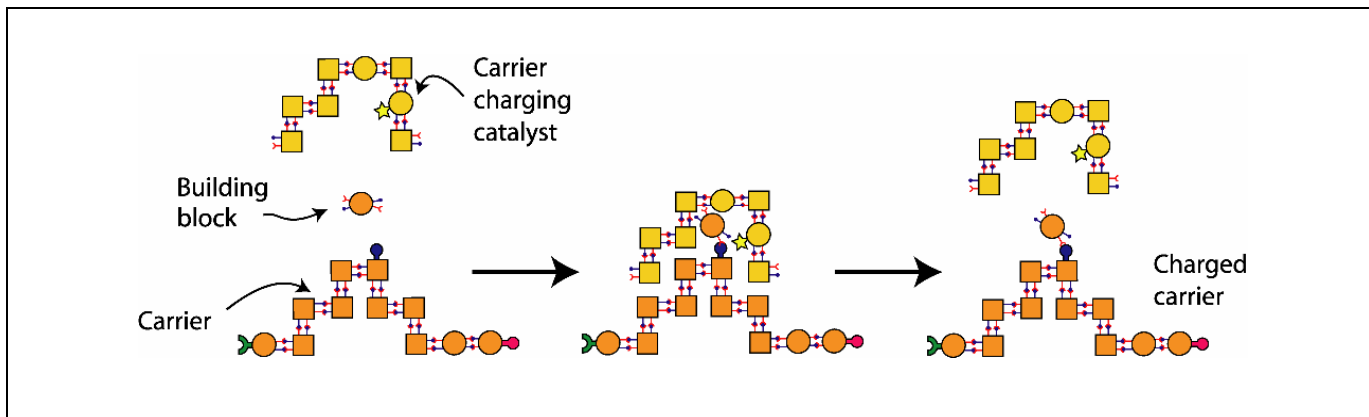
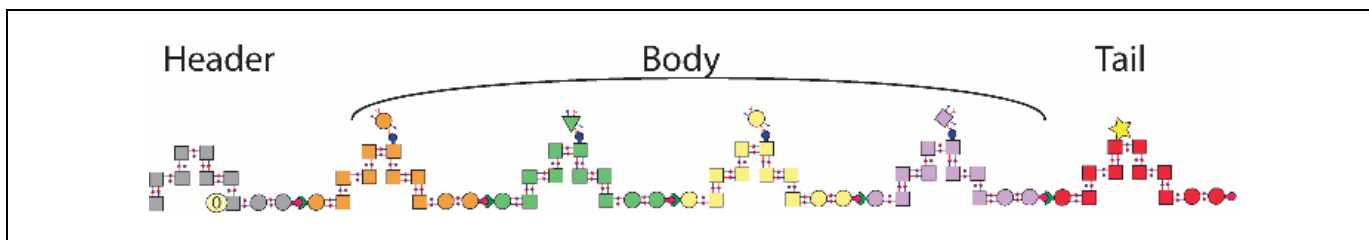

**Figure 14. Carrier chargers activate building blocks and couple them to carriers.**

**Carrier chargers are responsible for the fidelity of oligomer synthesis. They are analogues of aminoacyl-tRNA synthetases.**

### Syntrains

Syntrains are linear trains of carriers with a header and a tail (Figure 15). The header can be activated to bind an assembler and start the synthesis of a new oligomer. Syntrains combine the roles of messenger RNA and transfer-RNA into one object.



**Figure 15. A synthesis train or syntrain is a chain of carriers, like a train of boxcars that consists of a header, a body made up of a series of carriers and a tail carrier.**

**The carriers of the body are loaded with their specific building blocks by carrier chargers. The tail doesn't have a building block but instead has a catalyst that will allow a water molecule to release a newly synthesized oligomer from the last carrier of the body.**

### Assembler and the Synthesis of a New Oligomer

The assembler is a large structure on which activated syntrains assemble a new oligomer (Figure 16, Figure 17). The assembler is a simplified analogue of the biological ribosome. It has three stations syntrains move across in sequence, one carrier at a time. As the syntrain moves through the assembler, carriers are folded up against each other so that the building block of the trailing carrier attack the building block of the preceding carrier and transfer it to

the trailing building block. This causes the new oligomer to grow by one building block for each step the syntrain makes across the assembler. It's important that the syntrain doesn't advance until the oligomer extension has taken place. How exactly this is done isn't clear right now but natural ribosomes do this. The assembler will also deactivate the header of the syntrain so that it doesn't start feeding into a second assembler as it comes off the first assembler. Its carriers need to be recharged and its header needs to be reactivated first.

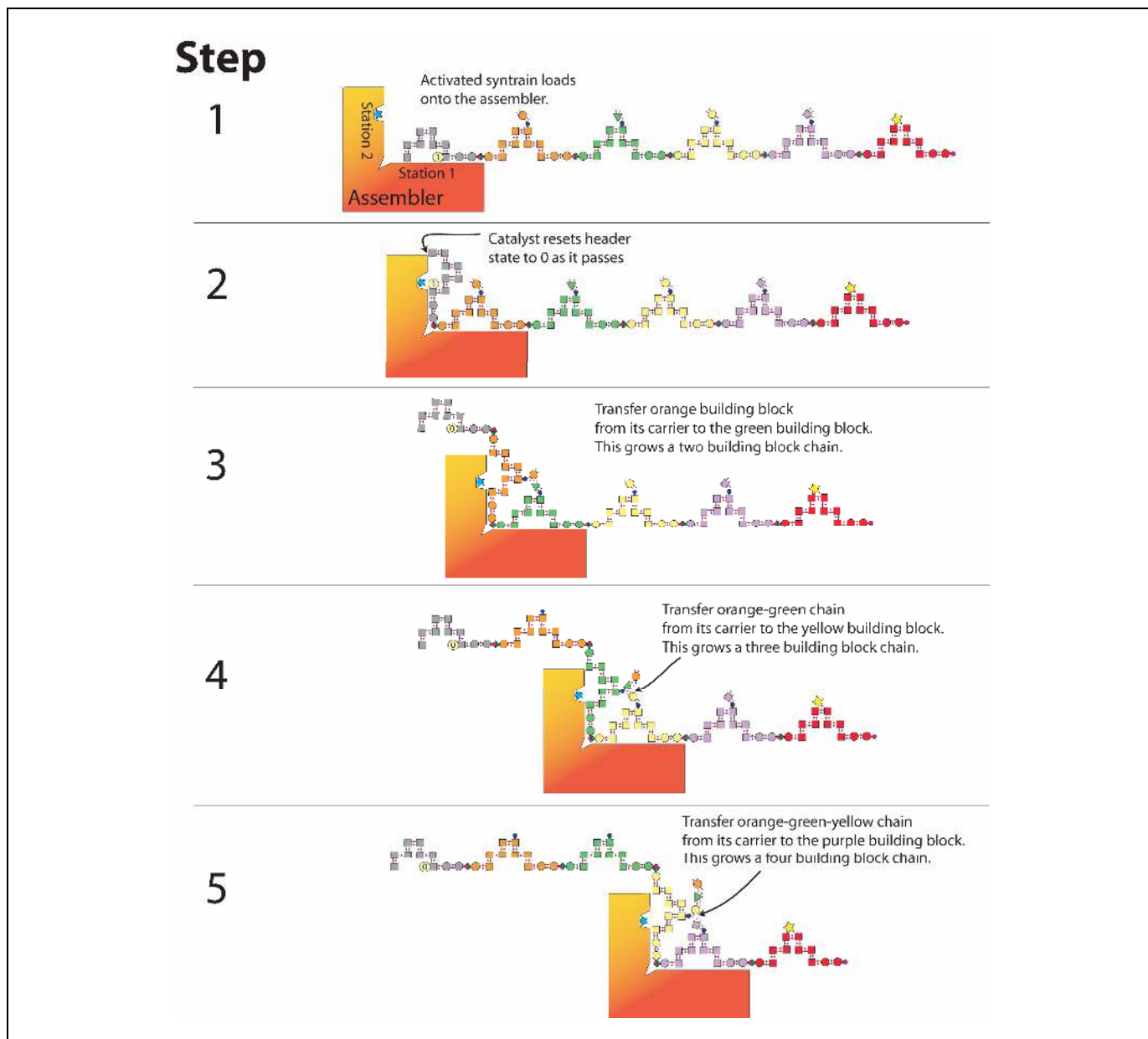

**Figure 16. The first steps of oligomers synthesis.**

(Step 1) A syntrain with an activated header has bound to station 1 of the assembler and it advances to station 2. (Step 2) The header encounters a catalyst that deactivates it so that it won't be recognized by another assembler until it is reactivated; the syntrain then advances one step. (Step 3) The first carrier is folded up against the second carrier, causing the orange building block on the first carrier to be transferred to the free amine on the second (green) building block; coupling the first two monomers of the oligomers. The syntrain then advances. (Step 4) The chain of two monomers is transferred to the third monomer (yellow) and the syntrain advances. (Step 5) The syntrain advances and the oligomers chain is extended until the last monomer is attached. This process will continue until the entire oligomers is assembled (Figure 17). The syntrain cannot advance until the oligomer has been extended (look to real ribosomes to see how this could be controlled).

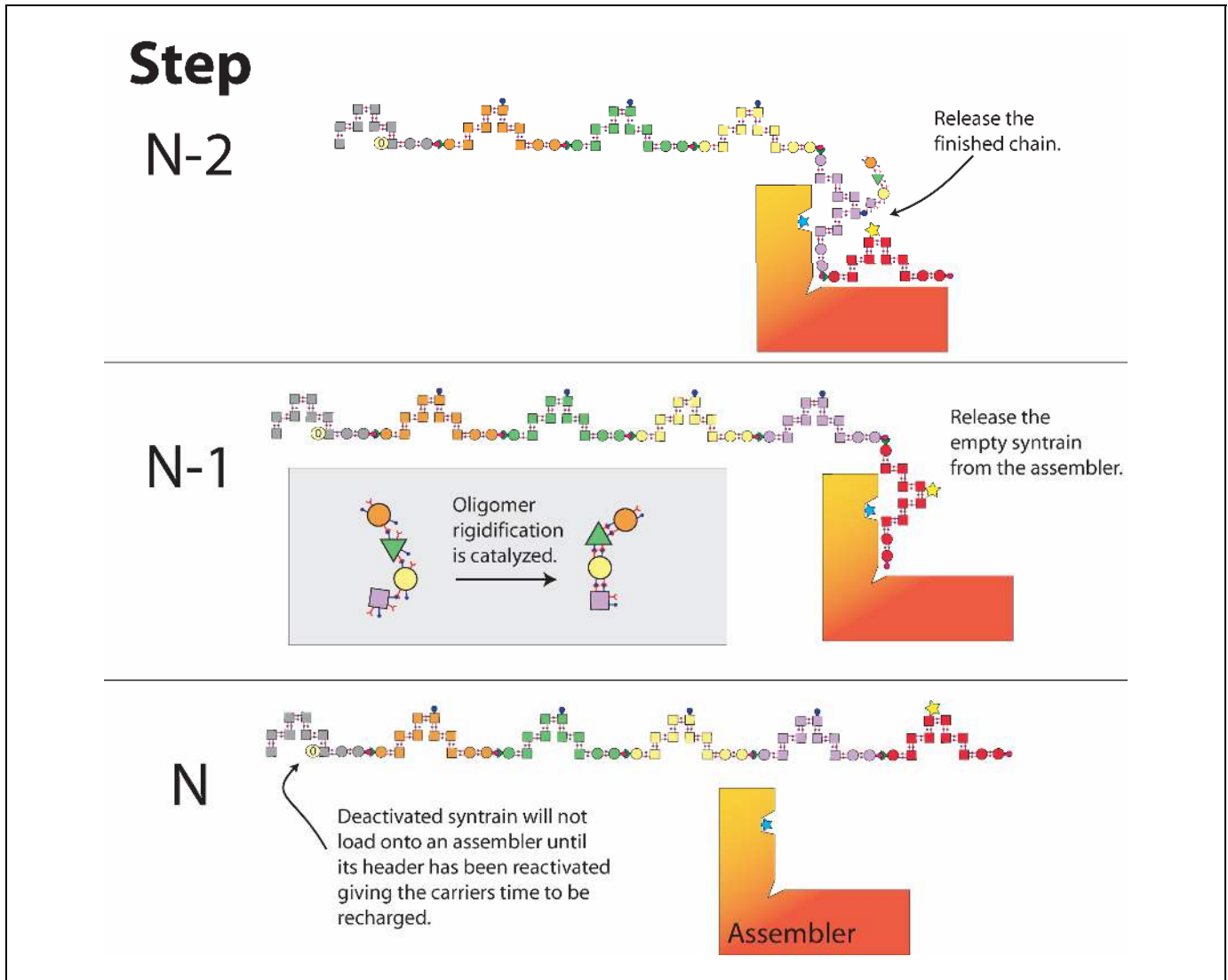
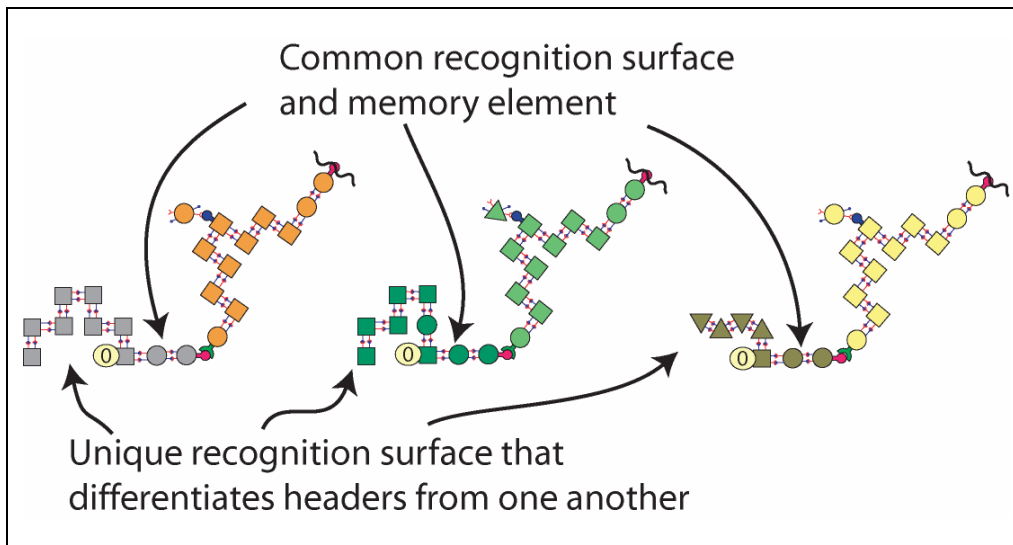

**Figure 17. The final steps of oligomers synthesis are shown.**

(Step N-2) The last carrier is a "stop" carrier that releases (hydrolyzes) the oligomer from the second to last carrier. (Step N-1) The syntrain advances and falls off the end of the assembler (step N-1). The newly assembled oligomers then goes on to rigidify and carry out its function in the culture.



*Headers and Controllers*



**Figure 18. Illustration of the function of recognition surfaces and memory elements.**

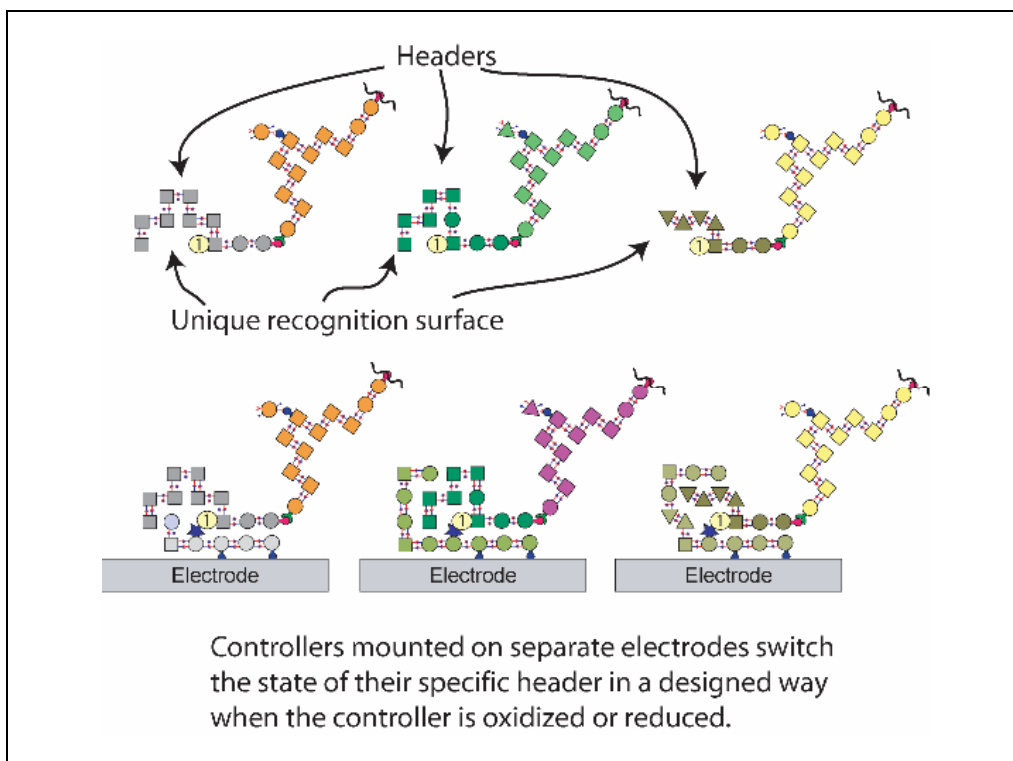

**Figure 19. Illustration of the function of headers and controllers.**

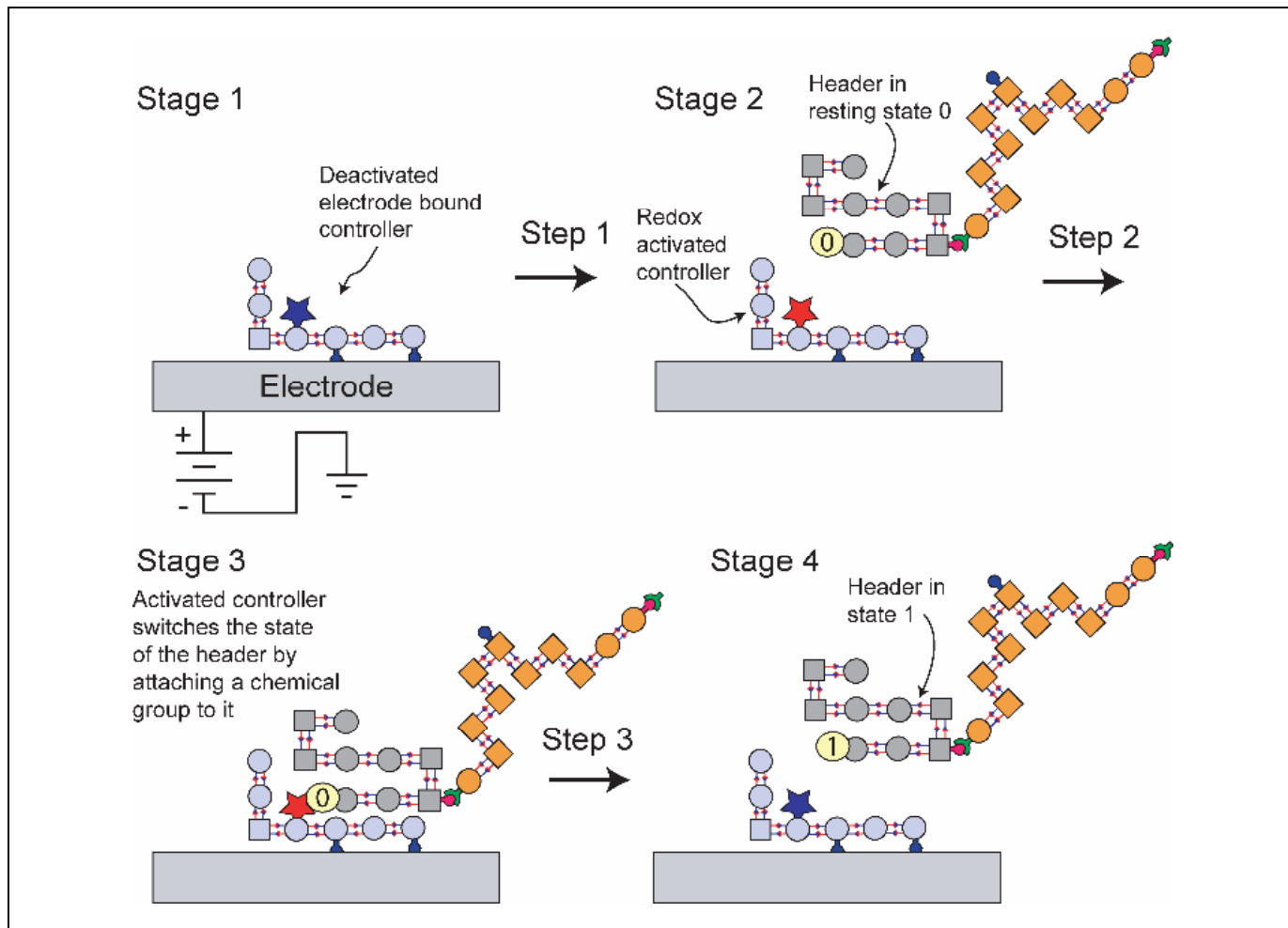

**Figure 20. The state of a header would be switched by oxidizing a controller that was attached to an individually addressable electrode.**

*Assembling Syntrains with Designed Sequences by External Control*

This is the idea that makes the machine solution *programmable* and with the proper software, would allow one to build almost anything. The idea is to activate controllers in an appropriate sequence to insert carriers into a growing syntrain. An analogy would be if we could connect a cell to a computer interface and assemble messenger RNA on the fly. This would allow the assembly of syntrains that would build new assemblers, new carriers, headers,

controllers, and catalysts to synthesize every building block in the solution. This would allow the reproduction and amplification of every component in the solution. It would also allow the construction of syntrains that build new oligomers that function as self-assembling motors and structural elements to create more complex and capable nanostructures. Figures 21, 22, and 23 illustrate the concept.

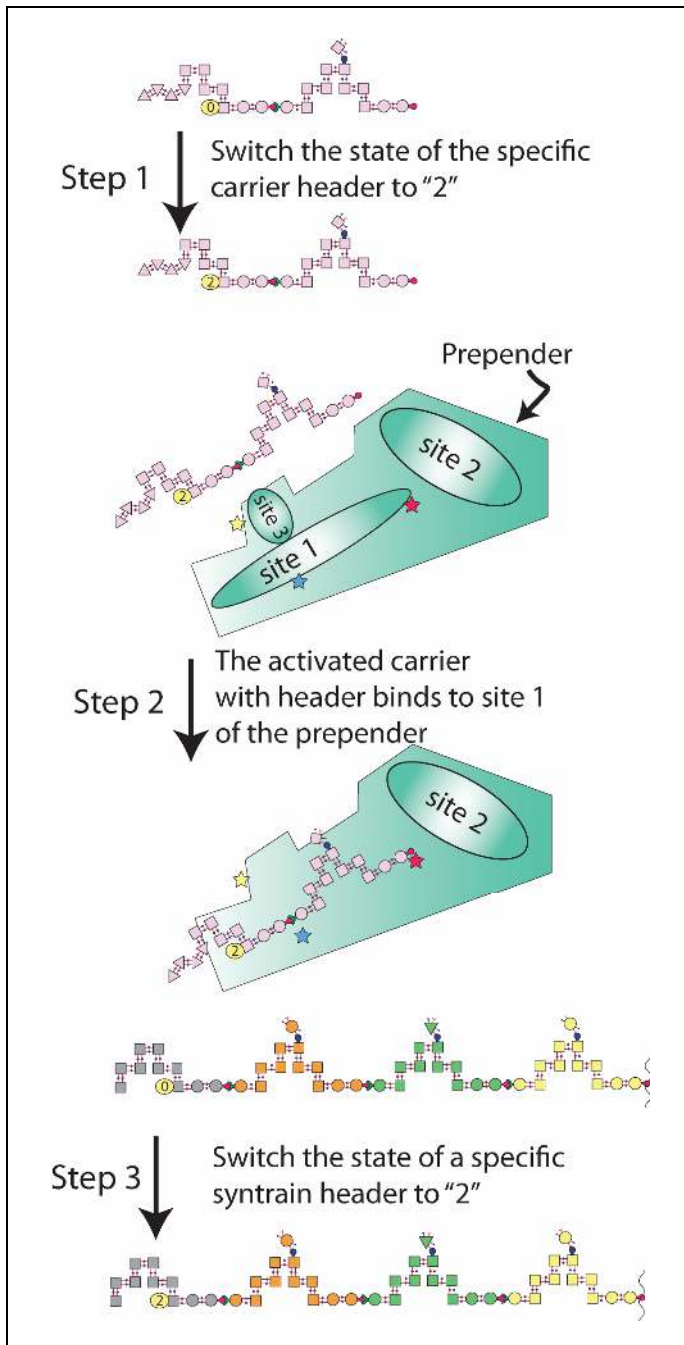

Figure 21. Initial steps for syntrain assembly.

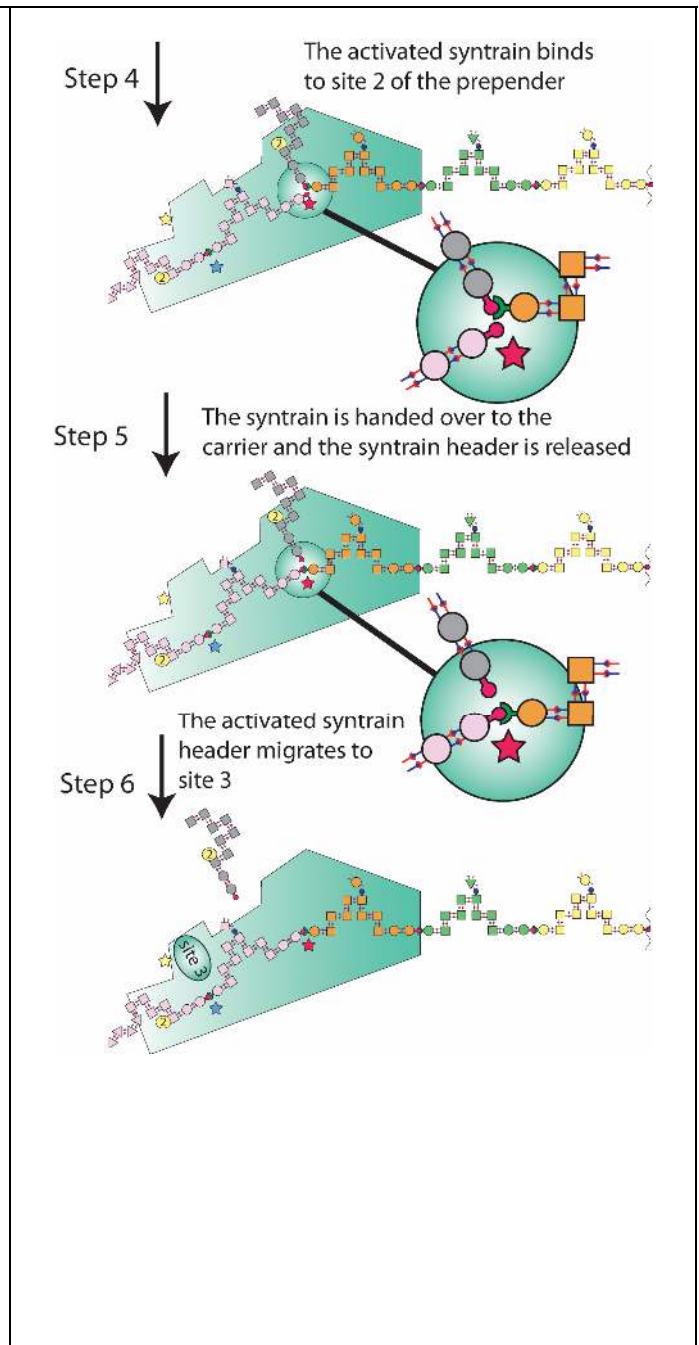
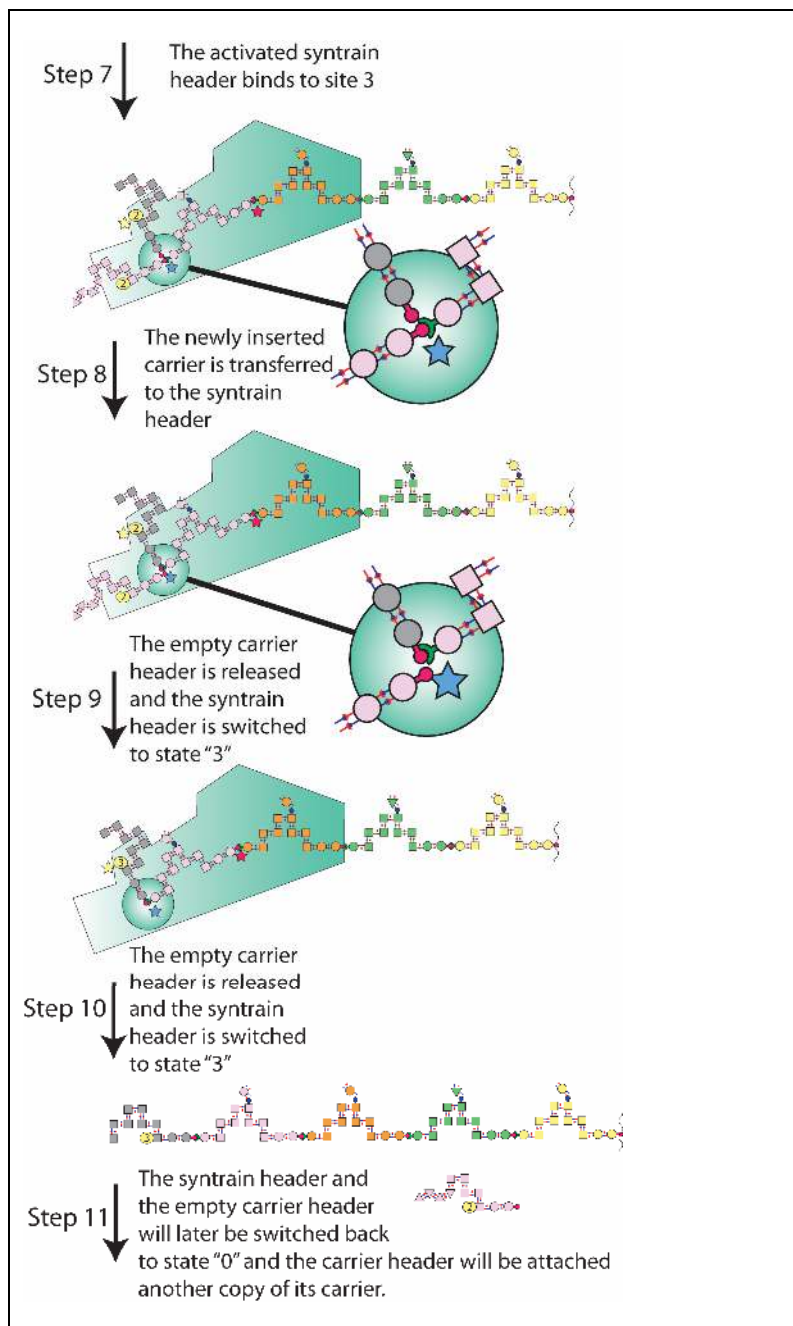
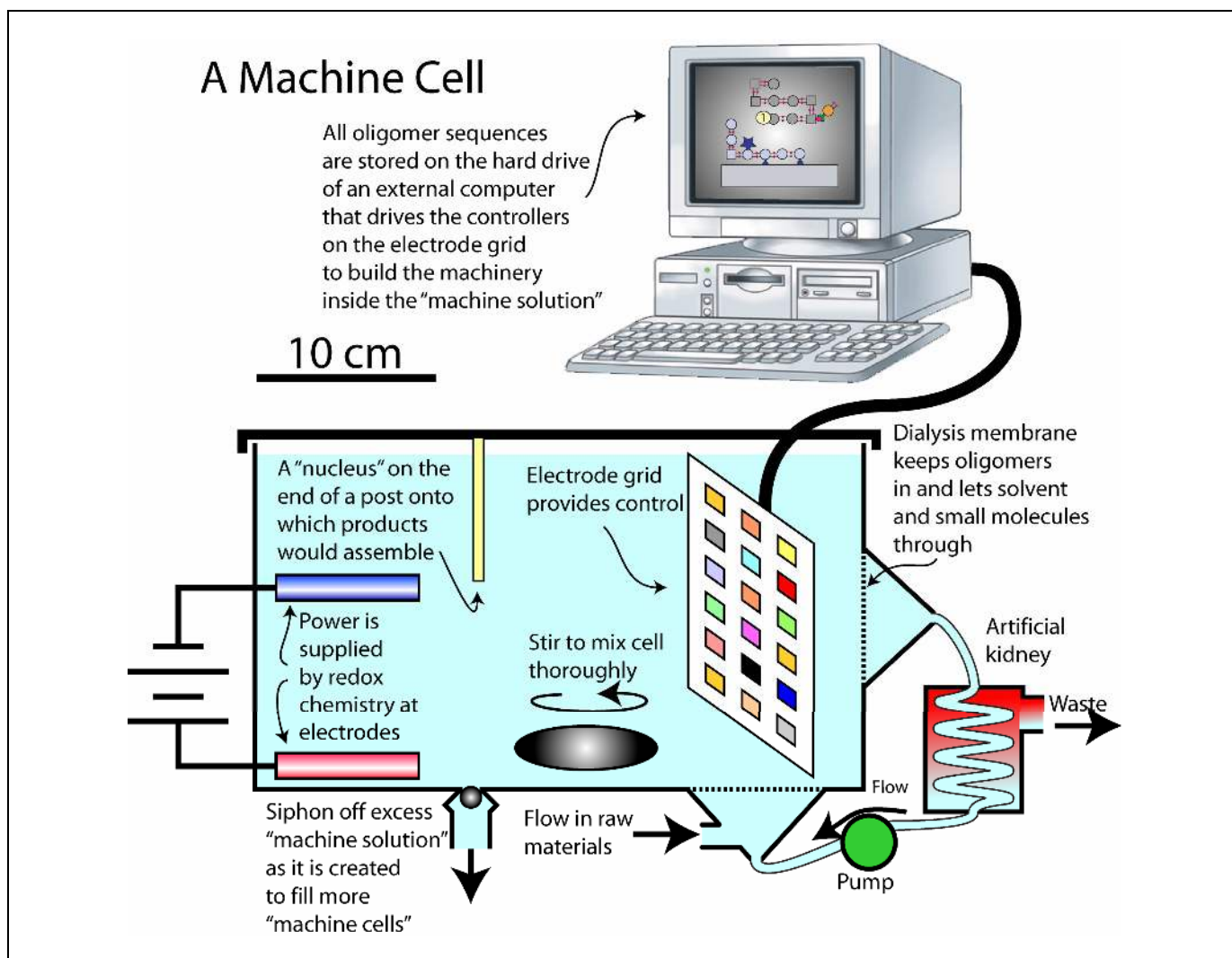

Figure 22. Intermediate steps for syntrain assembly.



**Figure 23. Final steps for syntrain assembly.**

## The Programmable Machine Culture



**Figure 24. Illustration of PC-driven nanostructure fabrication.**





## Atomically Precise Ceramic Structures

### Criteria

Normal ceramics become brittle when fired. But with ceramics made from particles spanning mere atoms in diameter, the final bulk material exhibits dramatically improved ductility after consolidations. This unusual combination of strength and suppleness derives from the material's two-phase nature. In atomically precise nanocrystalline materials, highly ordered, crystalline grains are surrounded by a more disordered, or amorphous, matrix of grain boundaries — much like tiny stones cemented by a semi-fluid mortar. And the volume of grain boundaries exceeds that in other nanostructured materials such as metals. In nanocrystalline ceramic structures because the grain boundaries are flowing, the material is more ductile than normal ceramic.

To understand, at the atomic scale, how nanocrystalline silicon carbide deforms under force, a team led by Szlufarska<sup>1</sup> performed a simulation in which they pressed a tiny virtual probe (an indenter) into the material's surface and watched how the atoms moved in response. Initially, the grains deformed and then sprang back as a unit, an illustration of the material's hardness. At this point, the grains all moved together because the grain boundaries held them together like glue. The grain boundaries initially take part in the deformation so in essence they protect the grains from breaking. But as the probe pressed deeper and exerted greater pressure, the researchers witnessed a surprising shift in the material's response. At a greater indentation depth, the grain boundaries began to yield, allowing individual grains to rotate and glide independently under the probe's force. In contrast, nanostructured metals go through no such phase; instead their grains take the brunt of the force, immediately developing defects like tiny cracks when the material begins to yield. Once defects occur in the system, the system is just weaker and it's going to break. This crossover in response from cooperative grain movement and hardness to individual movement and ductility is unique to nanostructured ceramics.

It is important to learn how to control the crossover point so as to engineer greater hardness into nanocrystalline ceramics without compromising pliability. For example, vary the volume of grain boundaries or the size of the grains. Impurities, or dopants, might also be added to the grain boundaries to make the material stronger. This is a unique time when the leading edge of materials design is exactly at the same length scale where fully atomic simulations could be possible.

<sup>1</sup> “Study May Expand Applied Benefits Of Super-hard Ceramics,” *Science Daily*, August 9, 2005

### Matrices

Ceramic materials have excellent high-temperature strength, chemical durability, and wear resistance. They are widely utilized in structural applications. In the field of functional ceramics, more prominent materials are strongly demanded from industries with the trend for higher efficiency, lighter weight and higher integration. The characteristics of ceramics are controlled not only by their bulk properties but also by the properties at their grain boundaries or interfaces. To engineer these properties, researchers should pay attention to the grain boundaries and interfaces of ceramics and should promote researches on:

- Analysis and evaluation technologies for atomically precise nanostructures and compositions
- Analysis and evaluation technologies for material interfaces
- Simulation and design technologies of interfaces
- 3-D microstructure characterizations and modeling
- Creation and manufacturing technologies for ceramic and ceramic composite materials with high performance and low cost

### Technology Enablers

- Simulation of nanoparticle and grain boundary deformation phenomena
- Simulation of ceramic/ceramic or metal/ceramic interfacial structures on first principle
- High resolution transmission electron microscopy observation and analysis of various interfaces
- Surface analysis of nanostructures with atomic form microscopes
- Development of technologies for large-scale production of atomically precise nanomaterials
- Development of nanofiber reinforced nanocomposite materials
- Development of consolidation technologies for nanomaterials to completely dense bulk materials to retain the precise nanostructures
- Development methods and techniques to evaluate precise nanostructured ceramics

## What the Technology Enables

The properties of ceramic materials, like all materials, are dictated by the types of atoms present, the types of bonding between the atoms, and the way the atoms are packed together. This is known as the atomic scale precise structures. The atoms in ceramic materials are held together by a chemical bond. The two most common chemical bonds for ceramic materials are covalent and ionic. For metals, the chemical bond is the metallic bond. The bonding of atoms together is much stronger in covalent and ionic bonding than in metallic. That is why, generally speaking, metals are ductile and ceramics are brittle.

Another structure that plays an important factor in the final property of a material is the microstructure. The microstructure of a material is the structure that can be seen using a microscope, but seldom with the naked eye. For ceramics, the microstructure can be entirely glassy (glasses only); entirely crystalline; or a combination of crystalline and glassy. In the last case, the glassy phase usually surrounds the nanocrystals, bonding them together like “glue”. Varying the volume of grain boundaries, reduce the size of the grains, adding impurities or dopants to the grain boundaries may change the bulk mechanical properties of the nanostructured materials significantly and make the material stronger. Adding impurities and dopants to the compositionally precise nanoparticles could produce materials with unusual chemical, mechanical, and physical properties.

## Applications

The atomic structure primarily affects the chemical, physical, thermal, electrical, magnetic, and optical properties. The microstructure also can affect these properties but has its major effect on mechanical properties and on the rate of chemical reaction. Due to ceramic

materials wide range of properties, they are used for a multitude of applications. In general, most ceramics are:

- hard
- wear-resistant
- brittle
- refractory
- thermal insulators
- electrical insulators
- nonmagnetic
- oxidation resistant
- prone to thermal shock
- chemically stable

Of course there are many exceptions to these generalizations. For example, borosilicate glasses (glasses that contain silica and boron as major ingredients) and certain glass ceramics (glasses that contain a crystalline phase) are very resistant to thermal shock and are used in applications such as ovenware, stove tops and kiln furniture respectively. Also, some ceramics are excellent electrical conductors and an entire commercial market is based on the fact that certain ceramics (ferrites) are magnetic. Unlike other exceptionally hard materials, these advanced nanostructured ceramics tend to bend rather than break, meaning they could be shaped into extremely long-lasting yet lightweight parts for everything from automobile engines, high-speed machining tools, armor parts, to medical implants in the body.

## Enabling Nanoscience for Atomically-Precise Manufacturing of Functional Nanomaterials

The unique functionalities exhibited by materials of nanoscale dimension result from both their size and their precise atomic structure. Effects of spatial confinement, high fractions of surface atoms, and the atomic structure at interfaces determine in large part the extraordinary electronic energy levels, chemical reactivity, and physical properties of nanomaterials which are crucial to the development of new functional materials.

Atomically-precise manufacturing (APM) is an ultimate challenge of materials science requiring control over both the size, shape, and atomic structure of nanomaterials during synthesis. This challenge can be considered because the number of atoms in such finite-sized structures limits their permutations and because the driving forces for self-assembly of nanostructures can be modeled. With such control, a nanomaterial's functionality can be predicted and controlled.

APM of nanostructures requires fundamental knowledge of their growth mechanisms. However remarkably, many extremely fundamental questions regarding both high- and low-temperature growth processes of nanomaterials are unknown, and await investigation by *in situ* diagnostic measurements during carefully-controlled synthesis and processing experiments.

### Challenges to Control Synthesis for APM: Single-Wall Carbon Nanotubes

No nanomaterial has been more widely studied or holds more promise for nanotechnology than single-wall carbon nanotubes (SWNTs). Individual carbon nanotubes exhibit phenomenal electrical, thermal, and mechanical properties (including ballistic conductance, thermal conductivity exceeding diamond, and Young's modulus >1 TPa) which place them at the forefront of nanoscience research for energy needs.<sup>1</sup> Because of their extraordinary properties and enormous potential for practical applications, controlling the synthesis of carbon nanotubes (CNTs) with specific properties defined by their lengths, diameters, and chiralities requires understanding of their growth mechanisms. In 1995, Smalley's group at Rice University discovered that exclusively single-wall carbon nanotubes (SWNTs) grow by laser vaporization (LV) of composite metal/carbon targets at high temperatures.<sup>2</sup> Large-scale arc synthesis followed in 1997.<sup>3</sup> These two methods represent **high-temperature** approaches involving vaporized carbon and typically produce almost exclusively SWNTs within a very narrow range of diameters (e.g. 1.2–1.4 nm) despite a wide variety of catalyst nanoparticle sizes (2–20 nm) which are initially molten. Under certain conditions, laser and arc synthesis methods can form single-wall carbon nanohorns or multiwall

nanotubes without metal catalysts.<sup>4,5</sup> By contrast, CVD of SWNTs proceeds at **low temperatures** (as low as 325°)<sup>6,7</sup> and utilizes the catalyst nanoparticles' interaction with hydrocarbons and their fragments. The catalyst nanoparticle diameter largely determines that of the nanotube in CVD, and multiwall nanotubes are preferred, resulting in a wide distribution of nanotube diameters and wall number under most conditions, and nanotubes are not formed without the metal catalysts.

Despite the intense interest in carbon nanotubes and their potential significance to the worldwide economy,<sup>8–13</sup> the detailed mechanisms of their growth and methods to control their synthesis remain some of the most important and fundamental questions in nanoscale science. These fundamental scientific questions hold great significance as the properties of **macroscopic nanotube assemblies** have been envisioned to approach that of individual nanotubes, promising materials with stunning thermal, electrical, and mechanical properties for energy-related applications.

However, in order for these applications to become reality, two central challenges of nanoscale synthesis must be understood: First, since the electronic properties of nanotubes depend so sensitively on their atomic structure, an atomic scale understanding of how **nucleation** determines atomic structure must be gained. Second, for economic production of nanotubes in long lengths and quantities sufficient for applications, their **growth** kinetics must be understood and controlled.

Remarkably, despite 10 years of research on their macroscale synthesis by both high- and low-temperature methods, several fundamental questions of SWNT nucleation and growth remain hotly debated, including specifically<sup>14</sup>:

1. The timeframes and energetics for nucleation.
2. The feedstocks for growth in both high- and low-temperature nanotube synthesis.
3. The state of the metal nanoparticle during growth in both high and low-temperature synthesis methods.
4. Whether carbon dissolves and diffuses through the metal catalyst nanoparticle to grow a nanotube, or whether nanotubes grow from complex surface chemistry on a metal nanoparticle (see Figure 1).
5. The factors which determine the diameter, chirality, and numbers of walls of a nanotube.
6. The roles of hydrogen and intermediate gas phase reactions in sustaining growth.
7. The mechanisms for growth termination.

8. Whether growth can be stopped and restarted after catalyst poisoning.
9. The roles of the catalyst support on the chirality of the resulting nanotube.

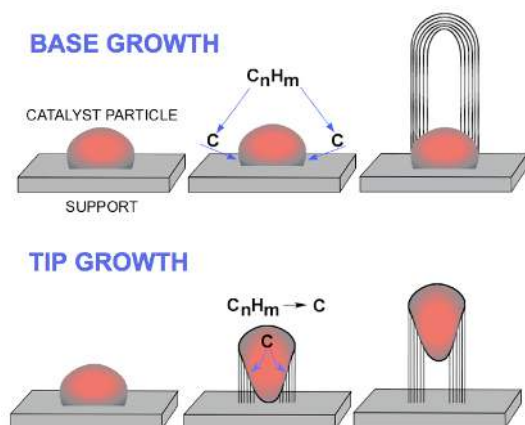

**Figure 1. Illustrations of base and tip growth modes of carbon nanotubes by chemical vapor deposition, for which many fundamental questions remain unanswered..**

## Development of *in situ* Diagnostics, Modeling, and Characterization

To answer these questions and address APM of SWNTs, *time-dependent, in-situ characterization* of both the nanostructure evolution and the growth environment must be simultaneously measured. Nanostructure evolution must be characterized across multiple length scales, from individual atoms to structures of finite size and shape. Similarly, the growth environment must be characterized and controlled through the development of highly versatile and controllable growth methods in conjunction with the development and application of novel *time-resolved, in-situ diagnostics*. These measurements provide the critical link to modeling nanomaterial synthesis, for the rapid exploration of new functional nanomaterials. SWNTs are ideal subjects for studies of nanostructure growth because their diameter and exact structure (chirality) can be unambiguously assigned through optical spectroscopic techniques (both *in situ* and *ex situ*).

The dimensions, purity and level of defects of nanomaterials depend sensitively upon their synthesis conditions. Thus, for example, single-wall carbon nanotubes grown by high- and low-temperature processes have differences. SWNTs grown by high-temperature techniques typically have smaller numbers of defects and narrower diameter distributions compared to those grown using low temperature methods. These differences appear to result from top-down vs. bottom-up nucleation and growth mechanisms.

**High-temperature synthesis methods**, in general, employ arcs or plasmas with temperatures initially in excess of 10,000K or more to completely vaporize a solid, liquid, or gaseous feedstock to its atomic and molecular constituents, after which the materials condense and interact to form new nanostructures. Methods include laser vaporization, electric arc, and plasma spray techniques in their various permutations. In general, the plumes of vaporized material are confined in time and space by a background gas. This trapped plasma can be envisioned as a microreactor where loose nanomaterials grow without substrates. Computer simulations of processes occurring within such environments seek to determine the stable thermodynamic nanostructures favored by minimization of total energy. For catalyst-assisted nanomaterials synthesis processes (such as for C SWNTs), it is generally assumed that a metal nanoparticle is first required before nucleation and growth. *In situ* diagnostics for this environment (see Fig. 2) are typically those employed for plasma spectroscopy or combustion research, involving gated imaging, pyrometry, and spectroscopy (absorption, fluorescence, laser-induced fluorescence, incandescence, and scattering) which provide snapshots of temperatures (electron, ion, rovibrational molecular, etc.), number densities, particle sizes, and complex dynamics involving hydrodynamic mixing and thermalization of gases. Such measurements reveal, for example, that metals condense to form nanoparticles ~ 1 ms after the laser vaporization event when the plume temperatures have cooled to ~ 1750°C.<sup>15,16</sup> However, within this high-temperature environment, materials can self-assemble into remarkable structures without catalysts (e.g. C into fullerenes or single-walled carbon nanohorns<sup>17</sup>, or BN into boron nitride nanotubes), thereby competing with the catalyst-assisted processes. Due to the relatively long times (microseconds to milliseconds) required for plume thermalization and condensation, atomistic methods for computer simulation are currently inadequate for atomically precise simulation of the nucleation and growth processes. New paradigms for multiscale modeling are required to bridge the timescales from picoseconds to milliseconds to understand and model atomically precise manufacturing of nanomaterials by high-temperature synthesis methods.



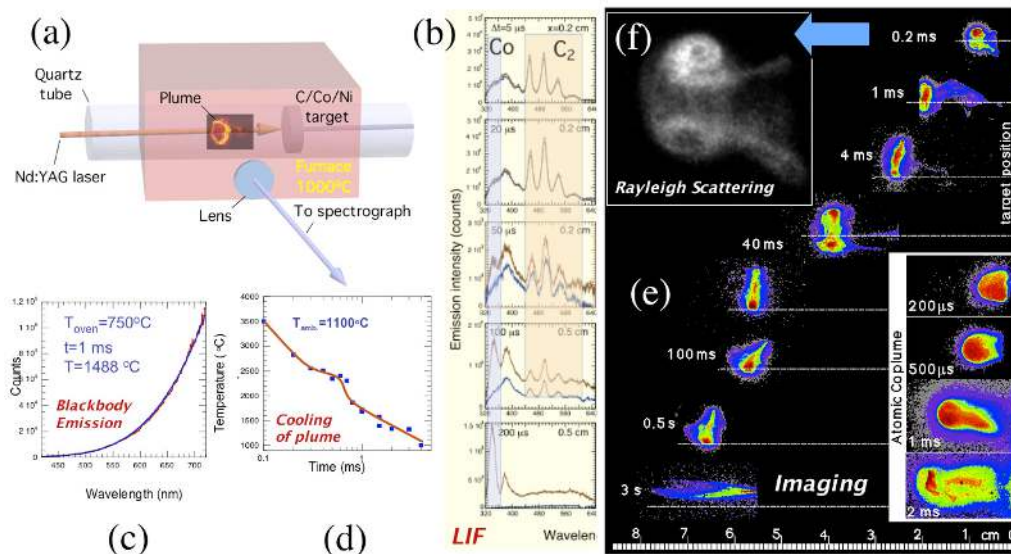

**Figure 2.** Time-resolved, *in situ* diagnostics of nanomaterials synthesis at high temperatures, applied to a 98% C target with 1% each Co and Ni ablated by an Nd:YAG laser. (a) A windowed tube furnace permits imaging and spectroscopy of the laser vaporized atoms, molecules, and clusters. (b) Emission spectra from excited atoms and molecules in the plume are collected both without excitation (lower traces) and with (upper traces) time-delayed excitation using a second laser to excite ground state neutrals in the plume. Here,  $C_2$  is observed to disappear within 0.5 ms after laser ablation, and neutral Co atoms are observed to increase in population as the hot laser plasma recombines during the same period. (c) As clusters and nanoparticles form, blackbody radiation is observed, which can be used to estimate the temperature of the ejecta. (d) These temperature measurements are used to observe that the hot clusters cool to the 1000°C oven temperature within 4 ms after laser ablation. (e) Imaging of the plume at long times is accomplished using gated, intensified CCD-array imaging of the laser-excited clusters to reveal the plume dynamics. The inset shows a color-filtered image to observe laser-excited Co atoms, which confirm that they condense into clusters during 1 ms  $< t < 2$  ms times, after the C in the plume has already converted to clusters. (f) Rayleigh scattering imaging of the plume records scattered light from clusters and nanoparticles induced by the second, time-delayed laser pulse, here revealing that the ejecta are trapped within vortices caused by the plume expansion.

**Low-temperature synthesis processes** such as chemical vapor deposition (CVD) rely upon catalysts to overcome energy barriers to nanomaterial synthesis. Catalyst nanoparticles are deposited upon substrates to (in general) to simultaneously (i) chemically decompose feedstock gases to produce a viable intermediate species, and (ii) assist in the incorporation of this intermediate species (either by dissolution or surface reaction) into the nucleated nanomaterial structure. *In situ* diagnostics for these processes are, in principle, much simpler. However, remarkably few *in situ* diagnostic measurements of CVD growth of nanotubes had been performed until the past few years. Several *in situ* environmental HRTEM studies of nanotube growth have been performed during the past few years which have provided invaluable glimpses into the processes involved in CVD.<sup>18,19</sup> In addition, optical techniques have been developed to measure and monitor growth kinetics under actual conditions as nanotubes grow to lengths as long as several millimeters in order to

understand reasons for growth termination, whether growth can be stopped and restarted, and effects of feedstock flow rate, composition, and chemistry on nucleation and growth kinetics (see Figure 3).<sup>20</sup> These measurements permit the development of growth models which should be invaluable to nanomanufacturing.<sup>21,22</sup> For a given choice of metal catalyst composition and feedstock gas mixture, a few measurements of growth kinetics and terminal length of nanotubes at different temperatures can be used to predict the optimal temperature and flow for maximum growth rate and terminal length. However, for APM of SWNTs the nucleation event must again be understood. Although perhaps conceptually simpler (because a preformed metal catalyst particle may be employed), the timescales for nucleation appear to be longer and more complicated chemistry must be modeled (involving both decomposition of the feedstock gas, subsequent chemical reactions to form intermediates, and dissolution/diffusion/reaction of these intermediates on the catalyst nanoparticle). Again, current

atomistic computer modeling tools to simulate these dynamics are inadequate. However, recent experimental advances with well-controlled catalyst nanoparticles supported on well-characterized catalyst supports have shown that limited sets of SWNT chiralities result. These

experiments indicate that through careful control of metal catalyst nanoparticle synthesis and processing, thermodynamic variations can be minimized to nucleate a particular range of atomically-precise nanostructures.

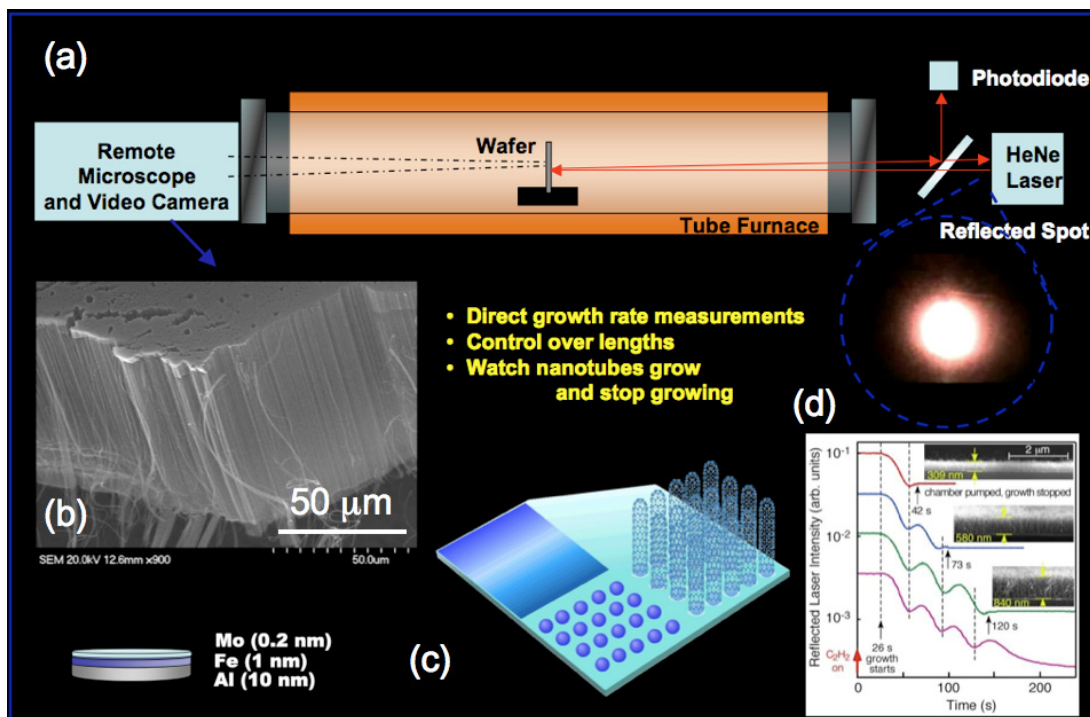

**Figure 3. (a) Optical imaging and time-resolved reflectivity (TRR) can be simultaneously applied to monitor and control (b) vertically-aligned nanotube arrays (VANTAs) during growth. (c) Catalyst films roughen into nanoparticles, which grow aligned arrays of nanotubes during CVD. (d) TRR fringes occur due to Fabry-Perot interference between reflections from the top and bottom surfaces of the array, providing indicators of height which permit *in situ* kinetics information to be obtained continually throughout a growth run, and permit mechanisms to control the length of nanotubes.**

## Summary – Basic Science Required for Atomically Precise Manufacturing

In summary, basic science must continue to address both nucleation and growth processes of nanomaterials through well-characterized, controlled synthesis experiments in order to enable atomically-precise manufacturing of nanostructures. During the past few years, *in situ* characterization methods have begun to be developed to understand both the growth environment and the evolution of nanostructures in real time. High-resolution environmental electron microscopy has revealed valuable information regarding growth mechanisms through videography of nanotubes growing by CVD, yet the resolution is still insufficient to resolve atomic structural correlations between nanoparticle and resulting nanotube. However, optical spectroscopy is capable of individually and remotely identifying the atomic structure of a nanostructure

during synthesis. Combinations of techniques such as these will be required to provide the real-time diagnostic information on single nanostructures necessary to understand nucleation and growth for APM.

Large-scale synthesis (i.e. nanomanufacturing) of nanostructures with APM presents special challenges and *in situ* diagnostics. Can the special thermodynamic and chemical conditions required for APM of a single nanostructure (e.g. on a TEM grid, or under a microscope) be reproduced in economical, scale-up reactors? *In situ* diagnostic techniques developed in the laboratory for gram-quantity production must be translated to scaled reactors. For high-temperature growth approaches, the natural selectivity of narrow SWNT diameter distributions (despite the seemingly chaotic synthesis process) implies that further

understanding of the nucleation event and understanding of nucleation energetics may further enhance selectivity toward APM. For low-temperature approaches, where the correlation between the catalyst nanoparticle size, shape, composition, and orientation and the crystal structure of the corresponding SWNT are just now being understood, there are real hopes that basic science can be translated into large-scale APM. Chemical engineering approaches (e.g. fluidized bed technology) capable of ton-quantity production levels are poised to translate advances for loose nanomaterial production from basic science to manufacturing. Basic research, through the application of *in situ* diagnostics, growth modeling, and understanding of chemical reactions, has been able to rapidly produce self-aligned arrays of nanotubes in macroscopic quantities with desirable properties.<sup>23-25</sup> Economic and large scale nanomanufacturing of atomically-precise SWNTs and other nanostructures will require further understanding of the basic science of nucleation and growth, and the evolution of defects during extended time periods, in order to initiate desired nanostructures, maintain quality and properties throughout growth, and avoid the production of chemical byproducts which incur expensive and environmentally prohibitive purification treatments.

## Acknowledgments

Research sponsored by the Division of Materials Sciences and Engineering, Office of Basic Energy Sciences, U.S. Department of Energy, under contract DE-AC05-00OR22725 with Oak Ridge National Laboratory, managed and operated by UT-Battelle, LLC.

## References

1. *Nanoscale Science, Engineering and Technology Research Directions*, report prepared for the Basic Energy Sciences Program, U. S. Department of Energy, Oak Ridge National Laboratory, 1999.
2. T. Guo, P. Nikolaev, A. Thess, D. T. Colbert, and R. E. Smalley, "Catalytic Growth of Single-Walled Nanotubes by Laser Vaporization," *Chem. Phys. Lett.* **243**, 419 (1995).
3. C. Journet, W. K. Maser, P. Bernier, A. Loiseau, M. L. delaChapelle, S. Lefrant, P. Deniard, R. Lee, and J. E. Fischer, "Large-Scale Production of Single-Walled Carbon Nanotubes by the Electric-Arc Technique," *Nature* **388**, 756 (1997).
4. S. Iijima, M. Yudasaka, R. Yamada, S. Bandow, K. Suenaga, F. Kokai, and K. Takahashi, "Nano-Aggregates of Single-Walled Graphitic Carbon Nano-Horns," *Chem. Phys. Lett.* **309**, 165 (1999).
5. S. P. Doherty and R. P. H. Chang, "Synthesis of Multiwalled Carbon Nanotubes from Carbon Black," *Appl. Phys. Lett.* **81**, 2466 (2002).
6. S. Hofmann, B. Kleinsorge, C. Ducati, and J. Robertson, "Controlled Low-Temperature Growth of Carbon Nanofibres by Plasma Deposition," *New J. Phys.* **5**, 153 (2003).
7. D. Kondo, S. Sato, and Y. Awano, "Low-Temperature Synthesis of Single-Walled Carbon Nanotubes with a Narrow Diameter Distribution using Size-Classified Catalyst Nanoparticles," *Chem. Phys. Lett.* **422**, 481 (2006).
8. M. S. Dresselhaus, G. Dresselhaus, J. C. Charlier, and E. Hernandez, "Electronic, Thermal and Mechanical Properties of Carbon Nanotubes," *Proc. R. Soc. London, Ser. A* **362**, 2065 (2004).
9. M. Endo, T. Hayashi, Y. A. Kim, M. Terrones, and M. S. Dresselhaus, "Applications of Carbon Nanotubes in the Twenty-First Century" *Proc. R. Soc. London, Ser. A* **362**, 2223 (2004).
10. J. Chen, V. Perebeinos, M. Freitag, J. Tsang, Q. Fu, J. Liu, and P. Avouris, "Bright Infrared Emission from Electrically Induced Excitons in Carbon Nanotubes," *Science* **310**, 1171 (2005).
11. M. Meyyappan, L. Delzeit, A. Cassell, and D. Hash, "Carbon Nanotube Growth by PECVD: A Review," *Plasma Sources Sci. Technol.* **12**, 205 (2003).
12. P. M. Ajayan, J. C. Charlier, and A. G. Rinzler, "Carbon Nanotubes: From Macromolecules to Nanotechnology," *Proc. National Acad. Sci.* **96**, 14199 (1999).
13. R. H. Baughman, C. X. Cu, A. A. Zakhidov, Z. Iqbal, J. N. Barisci, G. M. Spinks, G. G. Wallace, A. Mazzoldi, D. De Rossi, A. G. Rinzler, O. Jaschinski, S. Roth, and M. Kertesz, "Carbon Nanotube Actuators," *Science* **284**, 1340 (1999).
14. Joint Rapporteur report of the NASA/Rice SWNT Growth Mechanisms Workshop, C. Scott and S. Arepalli organizers, Burnet, Texas (2007).
15. A. A. Puzetzy, D. B. Geohegan, X. Fan, and S. J. Pennycook, *Appl. Phys. Lett.* **76**, 182, (2000).
16. A.A. Puzetzy, D.B. Geohegan, X. Fan, S.J. Pennycook *Appl. Phys. A* **70**, 153, (2000).
17. S. Iijima, M. Yudasaka, R. Yamada, S. Bandow, K. Suenaga, F. Kokai, K. Takahashi, *Chem. Phys. Lett.* **309**, 165, (1999).
18. S. Helveg, C. Lopez-Cartes, J. Sehested, P. L. Hansen, B. S. Clausen, J. R. Rostrup-Nielsen, F. Abild-Petersen, J. K. Nørskov, *Nature* **427**, 426 (2004).
19. S. Hofmann, R. Sharma, C. Ducati, G. Du, C. Mattevi, C. Cepek, M. Cantoro, S. Pisana, A. Parvez, F. Cervantes-Sodi, A. C. Ferrari, R. Dunin-Borkowski, S. Lizzit, L. Petaccia, A. Goldoni, J. Robertson, *NanoLetters* **7**, 602 (2007).
20. D. B. Geohegan, A.A. Puzetzy, I.N. Ivanov, S. Jesse, G. Eres, J.Y. Howe, *Appl. Phys. Lett.* **83**, 1851 (2003).
21. A.A. Puzetzy, D.B. Geohegan, S. Jesse, I.N. Ivanov, G. Eres, *Appl. Phys. A* **81**, 223 (2005).
22. R. F. Wood, S. Pannala, J. C. Wells, A. A. Puzetzy and D. B. Geohegan, *Phys. Rev. B*, **75** 235446 (2007).
23. K. Hata, D.N. Futaba, K. Mizuno, T. Namai, M. Yumura, S. Iijima, *Science* **306**, 1362 (2004).
24. G. Eres, A. A. Kinkhabwala, H. Cui, D. B. Geohegan, A. A. Puzetzy, and D. H. Lowndes *J. Phys. Chem. B* **109**, 16684-16694 (2005).
25. I.N. Ivanov, A.A. Puzetzy, G. Eres, H. Wang, Z.W. Pan, H.T. Cui, R.Y. Jin, J. Howe, D.B. Geohegan, *Appl. Phys. Lett.* **89**, 223110 (2006).





## Lithography and Applications of New Nanotechnology

### Lithography and this Roadmap

Sometime before the year 2000 critical dimensions (CDs) of state-of-the-art silicon integrated circuit products crossed below 100 nm and, in doing so, entered the size realm usually associated with nanotechnology. This industry is currently at the 45 nm technology node and is encountering significant technology and cost-of-ownership (COO) hurdles as it works towards future technology nodes at 32 nm, 22 nm, and below. The International Technology Roadmap for Semiconductors (ITRS) organization maintains and continuously updates a comprehensive roadmap for lithography for the silicon integrated circuit manufacturing community, and as a result no such roadmap will be repeated here. A summary of next-generation lithography (NGL) technologies that are addressed in that roadmap is:

- Immersion – optical lithography performed in a fluid medium that serves to reduce the effective wavelength by a factor of  $1/n$ , where  $n$  is the refractive index of the fluid;
- EUV – extreme ultraviolet lithography using 13.5 nm radiation, usually in conjunction with reflective optics;
- Imprint – nanoimprint lithography, in which a patterned hard mold is mechanically stamped into a resist using pressure, temperature and illumination;
- ML2 – Next-generation maskless lithography, a category that includes a number of maskless technologies such as electron beam direct patterning as well as maskless optical lithography.

### Alternative Lithography Technologies for Nanotechnology

However, while the ITRS roadmap addresses the needs of the large silicon manufacturing industry, it may be possible that other lithography technologies may find applications in atomically precise manufacturing due to completely different COO models. For one, unlike silicon technology, a possible APM application might require the fabrication of highly reusable nanostructured templates or devices with vanishingly small die sizes, which in either case could permit a high-resolution lithography technology to succeed in specific applications where it could not succeed in silicon due to COO issues.

Some lithographic technologies of note that are not specifically in the ITRS roadmaps, but that might be important to future APM technologies, are described in the following.

### *Dip-Pen Nanolithography (DPN)*

DPN is a technology based on the dispense of liquid material into specialized atomic force microscope (AFM) cantilever/tip assemblies and the deposition of that material at a tip/substrate interface. The combination of the material volume dispensed, the dwell time of the tip at a location, and interactions of humidity and the material/substrate interface can result in the writing of fine lines. While the technique is quite slow and limited to specific chemistries, recent demonstration of limited parallel tip writing and plans for future large parallel tools might make this technology attractive for APM.

### *Extremely High Resolution Electron Beam Lithography*

The availability of new aberration-corrected electron optical columns for transmission electron microscopes (TEM) and scanning electron microscopes (SEM), plus the development of sample stages based on technologies developed for AFM applications, have refreshed the possibility of extremely high resolution electron beam lithography in the sub-5 nm regime. However, the lack of resist development in this area, and especially the importance of resist proximity effects in the ultimate resolution of electron beam lithography, have limited the discussion of this technology in APM. Recent activity in the local e-beam deposition of metals using carboxyl-based chemistries, and the possible hybridization of e-beam with atomic layer deposition (ALD) technologies, may make this an interesting area of research and development for APM as well as semiconductor applications.

### **Extremely High resolution focused He beam lithography**

– A stable gaseous field He ion source has recently become available has been commercialized by ALIS Corp. which was acquired by Zeiss. The import of the He beam tool is a significantly smaller spot size  $\sim 0.25$  nm for the He beam vs 1-1.5 nm for electron beams. The more efficient and spatially confined manner in which light ions deposit their energy is also a significant advantage. Although, no serious attempts have yet been made to produce a lithography tool with a focused He beam from this new type of source, this will surely happen and will almost surely achieve high resolutions than possible with e-beams.

### **Scanning Tunneling Microscope (STM) lithography** –

Any APM technology that uses patterning will need atomic precision and none of the technologies previously mentioned have demonstrated that capability. Only STM enabled removal of H atoms or small molecules from semiconductor surfaces has demonstrated  $\sim 1$  nm resolution and has the potential for atomic precision.





## Scaling Up to Large Production of Nanostructured Materials

For many of the large-scale applications of atomically precise manufacturing to be successful, we must first be successful with scaling up existing nanoparticles and nanostructured materials using improvements and breakthroughs in conventional synthesis and manufacturing technologies. This supplemental report addresses the challenges and opportunities of scaling up nanostructured materials into large volume production. The information was primarily obtained from the U.S. Department of Energy Industrial Technologies Program's Nanomanufacturing for Energy Efficiency Workshop held in June 2007 (<http://www.eenm.govtools.us/>) as documented in the *Nanomanufacturing Roadmap for Energy Efficiency* (DOE Industrial Technologies Program, draft report, July 2007).

### Barriers for Nanomanufacturing

Commercial success of nanotechnologies will require high-volume production capabilities. The realization of these production capabilities will require new production methods, precision quality control, and analytical characterization techniques to analyze material consistency.

A major barrier to the commercialization of nanotechnology is the current **inability to produce large volumes of uniform nanomaterials** with the properties needed for incorporation into nano-enhanced products. The inability to produce uniform, high-quality nanomaterials results from lack of understanding of how synthesis impacts final products, inadequate production processes, and inadequate characterization equipment to monitor parameters that impact quality.

There is also a **lack of scalable unit operations for incorporation of nanomaterials into products**. Nanomaterials and products containing nanomaterials (e.g., nanotubes, inorganic powders, organic films, and coatings) are manufactured today with traditional manufacturing techniques and unit operations. These nanomaterials are prohibitively expensive for many applications due to high capital costs and low production volumes. Furthermore, byproducts, wastes, and impurities hinder commercial applications. Unique scale-up problems are associated with nanotechnology that traditional process engineering can't address. Robust and reliable production methods—consistently and correctly controlled at the atomic scale—are needed to significantly expand the commercial use of nanomaterials. In addition, production must be accomplished in a safe, environmentally friendly manner. There is also currently an **inability to retain nanoparticle functionality** as the materials are incorporated into products.

There is a need to develop deployable **process-monitoring tools** that can be used to ensure nanomaterials and nanoproduct consistency on a manufacturing scale. Such

instruments would include real time, on-line characterization tools and rapid quality control (QC) tests for samples. Real-time, in-line measurement techniques are needed to provide reproducible control of properties such as particle size and distribution. Improved analytical tools and process control will go a long way to achieving zero defects in final materials, reducing waste, and turning nanomaterials manufacturing into a commodity. Inadequate monitor and control of the manufacturing process results in manufacturing that cannot be reproduced. Extra processing steps must be performed because today's techniques cannot produce purified target materials the first time. Standardized measurement techniques do not exist.

**Predictive models** of nanomaterials behavior is also needed to cost-effectively implement nanotechnology. There is a need for correlations between nanomaterials properties and end-use performance to help design nanomanufacturing processes. There is also a lack of data and algorithms for use in these models. There is a disconnect between molecular dynamics modeling on the nanoscale and the material properties on the component scale modeling that is necessary to validate performance for designers. In the near term, industry needs nanostructure properties that they can feed into existing programs and generate standardized results that they can use to generate part and material specifications.

### Research and Development Needs for Nanomanufacturing

The recent evolution of computational, synthesis, and characterization tools that can now be applied at the atomic scale has resulted in significant academic research that is leading to discoveries of new nanomaterials. Robust and reliable production methods—consistently and correctly controlled at the atomic scale—are also needed to significantly expand the commercial use of nanomaterials. In addition, production must be accomplished in a safe, environmentally friendly manner.

The nature of working at the nanoscale dictates the need to simultaneously integrate R&D in materials synthesis, manufacturing, characterization tools, and modeling. Breakthroughs in each of these areas will provide capabilities to enable progress in other areas, ultimately leading to cost-effective manufacturing and integration into applications. An exceptionally high degree of interdependent, multi-disciplinary R&D performed by diverse stakeholders is required. The entire R&D effort must closely interweave developments in fundamental understanding of nanoscale properties, new materials synthesis methodologies, new manufacturing techniques, new characterization and control techniques, and new

modeling tools. The spectrum of invention required necessitates a series of parallel, intensely interwoven R&D activities.

## Priority R&D Needs for Manufacturing Nanomaterials

Current methods used to isolate nanoparticles from reaction media and to separate powders and solid materials (*e.g.*, purification, separation, and consolidation techniques) result in low yields (especially at low volumes), relatively large amounts of precursor waste, compromised performance, and finished products that cannot easily be reproduced. Inefficient processes add expenses and significant manufacturing costs to nanomaterials used both directly and as raw materials to subsequent materials.

The unique physics and chemistry at the nanoscale requires new approaches in many cases beyond that of the classical manufacturing unit operations in order to commercialize nanotechnology. They include:

- Synthesis – form desired nanomaterial building blocks from precursors in commercial quantities, with consistent quality
- Separation – separate nanomaterials from precursors, reaction media, etc.
- Purification – tailored isolation of nanomaterials by function (separate by desired property, such as size, composition, charge, magnetic, electrical, optical, functionalization, etc.)
- Stabilization – processes such as surface modification, dispersion, etc. that allow a consistent nanomaterial product to be utilized while retaining desired functionality

The manufacture of nanomaterials poses unique challenges to raw material specification, purity, and quality control not typically encountered when manufacturing materials of larger dimensions. Purifying nanomaterials after they are produced is extremely difficult and expensive; it is far easier to control these parameters on the front end of the process. Many of the processes are gas-phase reactions in which impurities are carried through the process unaltered and, in some instances, concentrated during the process. The final product may be complex matrices of intractable materials, which do not easily lend themselves to analysis. Ultimately, industry will need to establish strong customer-supplier partnerships to clearly define application needs and work backwards through the process to raw material inputs.

New technologies are needed to improve nanomaterials properties and performance. Examples include

improvements in the strength of materials and modules. Research is needed to establish the upper bounds for performance enhancements and demonstrate the repeatability of these performance enhancements.

Once produced, a nanomaterial (*e.g.*, nanoparticle, nanotubes) often needs to be modified for use in a specific application. Retention of the unique magnetic, electronic, mechanical, or other properties is critical. Thermal stability of the nanomaterials is a particular concern for high-temperature applications. Processes and design techniques are needed to allow new nanomaterials and devices to be scaled up rapidly and with cost-performance profiles that exceed competing technologies.

The development of scalable dispersion and surface-modification techniques are needed to enable reproducible nanomaterial stabilization and dispersion of nanomaterials into other materials. Fundamental R&D is required to develop a general understanding of the basic principles that allow processing that retains the nano-derived functionality. In addition, work will be needed with specific systems to develop unit operations that work across a range of materials of commercial interest, such as inorganic oxides, clays, carbon materials, etc., and matrices, such as polymers, pure liquids, solution gels/sols and metals.

Retaining properties and avoiding contamination, especially during scale-up from the laboratory to manufacturing, are the most important challenges faced when using a nanomaterial to meet application-specific requirements. The most common required modification is the de-aggregation and dispersion of the nanomaterial in a matrix (a *liquid*, as is the case for coatings and cosmetics, or a *solid*, as is the case for polymer composites or ceramics). Often, surface modification is required to enable dispersion. For example, functionalization of clay with organic molecules is used to improve dispersion of the clay in polymers. Additionally, surface modification is used to impart specific surface properties, such as the use of silane coupling agents with fumed silica to provide reaction with an epoxy or other matrix.

## Priority R&D Needs for Manufacturing Products Containing Nanomaterials

Realization of the full potential of novel nanomaterials is impossible without suitable processing techniques that go beyond miniaturized traditional manufacturing. Manufacturing approaches that utilize mass production techniques, modular assembly with building blocks, and integrated assembly are needed to reduce costs and accelerate the entry of nanomaterials into commercial application. Product consistency during scale up—from lab scale, to pilot scale, to commercial units—is essential for commercial success.

Example needs include reduction in processing steps with multi-functional nanomaterials, more efficient nanomaterials that require less product addition for equivalent performance; enhanced process equipment and consumables that are nanomaterial enabled; improved processes for nanomaterials synthesis, dispersion to required size, and nanomaterials synthesis rates; scale-up from bench-top to commercial capability for high volume manufacturing, i.e., single large-scale synthesis reactor vs multiple bench-top units operating in parallel.

The science of crossing material-scale boundaries and integrating nanomaterials into the macro world is in its infancy. Today, various processes have been demonstrated in isolation (e.g., e-beam lithography, self assembly of block copolymers). However, little research has focused on utilizing combinations of approaches to meet criteria for a target application. High-yield, sub-100 nm integration processes and methods are needed for integrating engineered materials at the device scale that retain properties of the nanoscale. Incorporating nanomaterials into devices and products will require their integration into heterogeneous materials, including organic/organic, organic/inorganic, and biological/organic materials. A combination of bottom-up and top-down assembly processes is expected to achieve this type of nanomaterial manufacturing and system integration. Integration methods will need to be cost-effective, environmentally friendly, and less labor- and energy-intensive than conventional methods.

The unique physics and chemistry at the nanoscale requires new approaches in many cases beyond that of the classical manufacturing unit operations in order to commercialize nanotechnology. This will involve developing a fundamental engineering knowledge of the unit operations for manufacturing organic and inorganic nanomaterials, developing scale-up path for self-assembly processes for commercial-scale unit operations, and developing and designing processes that integrate engineered materials at the device level while retaining properties of the nanoscale.

## Priority Characterization and Process Control R&D Needs

Nanoscale manufacturing R&D and high-volume, cost-effective production will not be possible without advanced characterization and process control tools. The development of robust manufacturing methods with nano-sized elements requires extensive process control. An effective control system requires accurate and timely measurements, rapid data assessment, and response parameters. Easy-to-use, economical tools for product assay and application-specific qualification are also needed. Integrating the process control components at the nanoscale will require a long-term

commitment to R&D in diverse science and technology fields.

The real-time characterization techniques for process monitoring and process control are similar to those needed for metrology, and include optical and spectroscopic analyses, mass spectroscopy and small angle X-ray scattering. Pathways for extension of these techniques to the unit operations of synthesis, separation, purification, stabilization/functionalization and assembly are needed. Nanomaterial characterization capabilities needs include monitoring the following: in situ particle size and shape, in situ composition or function (including charge; surface energy; functionalization, magnetic, electrical, or optical properties, etc.); surface chemistry at nanoscale including fractional coverage and thickness of coatings on nanoparticles, and quality of particle dispersion in a solid phase.

New techniques are needed for characterizing bandgap distribution, and determining particle size and particle surface roughness. Large-volume electronic property characterization of one-dimensional nanomaterials and in situ nano-particle (sub-50 nm) monitoring are the primary research need areas identified by the working group. Size distribution capability is needed for manufacturing controls and as environmental health and safety monitors.

Product consistency during scale up—from lab scale, to pilot scale, to commercial units—is essential for commercial success. Material samples for customer evaluation must be produced at the lab or pilot scale to control capital costs. However, customers must be assured that identical products can be made in a full-scale commercial unit. Mitigating the risk for both the manufacturer and the customer is critical to getting nanomaterials into application evaluations as quickly and expansively as possible.

## Priority Modeling R&D Needs

The smooth transition from the laboratory to commercial introduction will depend on the availability of robust modeling and simulation tools that can predict experimental outcomes. Laboratory experimentation can be cumbersome and time consuming, and often does not completely represent the final manufacturing conditions. Computer-aided modeling and simulation can supplement physical experiments, accelerate future research, and speed the time to the market by a factor of 2 to 10. For example, knowledge of cause and effect relationships based on laboratory observations can be used in models to simulate and predict the effects of environmental conditions (temperature, humidity), subtle process variances, batch-to-batch replication, and equipment scale. Computers can be used to successfully and economically mitigate the impacts of these effects.

Robust, high-confidence models and simulations are needed to predict the properties and behaviors of new nanomaterials and assembled systems across scales—from synthesis of particles through their integration into devices, and finally, to their performance in final products. Models and simulations will aid the development of synthesis and assembly protocols that impart and preserve required functional properties across scales. At the application level, they will define the functional needs and probable designs of nanostructures.

A new modeling paradigm is needed to combine lessons learned from experiments across the field of nanomanufacturing. It will be used to extrapolate properties (such as electronic, chemical, structural, toxicological, and environmental properties) from known conditions and apply them to novel cases. These models will be able to help design experiments, increase the efficiency of research, recognize and assess emergent properties, accurately predict performance, reduce the required number of design iterations and experiments, and reduce the number of tools required for design. Ultimately, a library of validated protocols will couple modeling and experimental results and will help researchers find customized material solutions for specific needs.

## Summary

Current methods used to isolate nanoparticles from reaction media and to separate powders and solid materials (*e.g.*, purification, separation, and consolidation techniques) result in low yields (especially at low volumes), relatively large amounts of precursor waste, compromised performance, and finished products that cannot easily be

reproduced. Inefficient processes add expenses and significant manufacturing costs to nanomaterials used both directly and as raw materials to subsequent materials. The unique physics and chemistry at the nanoscale requires new approaches beyond that of the classical manufacturing unit operations in order to commercialize nanotechnology. These include: synthesis, separation, purification, stabilization, and assembly into products. Nanoscale manufacturing R&D and high-volume, cost-effective production will not be possible without advanced characterization and process control tools. The smooth transition from the laboratory to commercial introduction will also depend on the availability of robust modeling and simulation tools that can predict experimental outcomes.

Success in nanomanufacturing will require a large, highly integrated, multidisciplinary, national effort focused on predictive design and manufacturing. Breakthrough in efficiency, productivity, safety, and environmental performance hinge on optimizing nanomanufacturing from a total systems perspective. The nature of working at the nanoscale dictates the need to simultaneously integrate R&D in materials synthesis, manufacturing, characterization tools, and modeling. Breakthroughs in each of these areas will provide capabilities to enable progress in other areas, ultimately leading to cost-effective manufacturing and integration into applications. New technologies promise increasingly efficient, clean, fuel-flexible, and reliable nanomanufacturing processes, capable of producing uniform high-quality end products at high production rates.



## Carbon Nanotubes

### Introduction to Carbon Nanotubes

Carbon nanotubes are one of the most well known nanomaterials and have been the object of much excitement since their landmark introduction in the early 1990s<sup>1</sup>. As a class of materials, carbon nanotubes represent a crystalline elemental form and allotrope of carbon, like the familiar diamond and graphite. Carbon nanotubes are a member of the fullerene family like their famous cousin  $C_{60}$ , for which the Nobel Prize was awarded in 1996. Carbon has the electron configuration  $1s^1 2s^2 2p^2$  and four outer shell electron orbitals:  $2s$ ,  $2p_x$ ,  $2p_y$ , and  $2p_z$ . The four valence electrons of C may hybridize these orbitals into  $sp^1$ ,  $sp^2$ , and  $sp^3$ , in which a carbon atom may be bound to 2, 3, or 4 neighboring atoms, respectively. This atomic bonding configuration directly affects the properties of the material. Diamond is composed of  $sp^3$  carbons and consequently is very hard, electrically insulating, and chemically quite inert. Graphite, carbon nanotubes, and fullerenes are composed of  $sp^2$  carbons. In contrast to diamond they can be quite electrically conductive (parallel to the direction of bonding) and are much more chemically- and photo- active than diamond. Though there have been many impressive demonstrations of unique carbon nanotube properties, there remains a gap between the unparalleled predicted performance that motivates carbon nanotube research and what has been achieved thus far.

### Structure of Carbon Nanotubes

Unlike graphite or diamond, a carbon nanotubes are discrete molecules of well-defined shape and size. The structure of a nanotube can be conceived of as a graphene sheet that has been rolled up and joined as the edges to form

a cylinder. The ends of the cylinder may be open, with reactive dangling bonds, or capped with hemispheres of carbon similar to halves of a fullerene molecule. The  $sp^2$  carbon atoms of the walls of a nanotube are naturally arranged into hexagons, like benzene rings, while the extremely curved end caps also include pentagons in their structures.

Though not the way that carbon nanotubes are actually formed, the concept of a rolled up graphene sheet is a useful device for describing an aspect of carbon nanotube structure referred to as "chirality". The precise structure of a carbon nanotube (other than its length) may be described by the indexes of its 'chiral vector' (also called 'wrapping vector' or 'roll-up vector':  $C_h = n\mathbf{a}_1 + m\mathbf{a}_2 \equiv (n, m)$ ), which connects crystallographically equivalent sites on the graphene sheet.  $\mathbf{a}_1$  and  $\mathbf{a}_2$  are the graphene lattice vectors, and  $n$  and  $m$  are integers. Armchair nanotubes have indices  $(n, n)$  and zigzag nanotubes  $(n, 0)$ . It is predicted that carbon nanotubes with  $(n-m)/3$  are metallic, while all others, termed 'chiral nanotubes' are semiconducting with a bandgap defined by their structure. The radius of the nanotube is  $r = C_h / 2\pi$ .

Carbon nanotubes may exist as individual cylinders, known as single walled carbon nanotubes (SWNTs), or may consist of concentric tubes-within-tubes. The two-tube example of this is called a double walled carbon nanotube (DWNT), while the general name for a carbon nanotube with more than one wall is a multi walled carbon nanotube (MWNT). The spacing between walls in a multi walled nanotube is similar to that between the graphene layers in graphite,  $\sim 0.34$  nanometers. The walls of a double or multi wall carbon nanotube do not necessarily have the same chiral indices as one another.

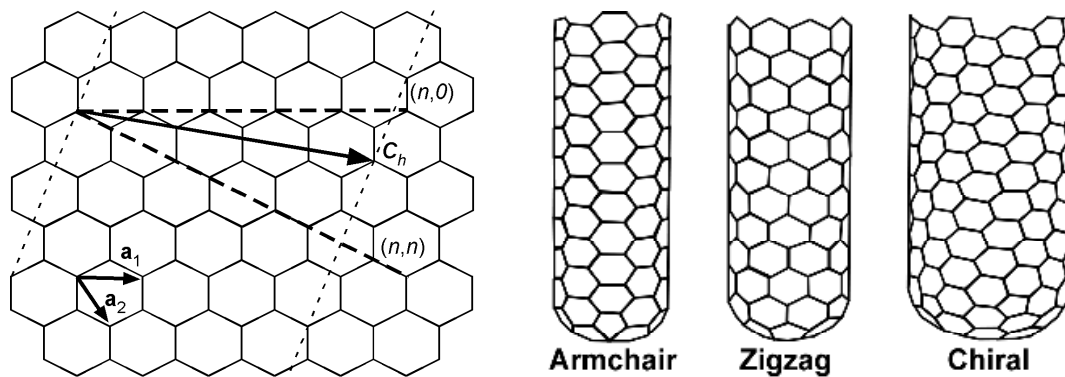

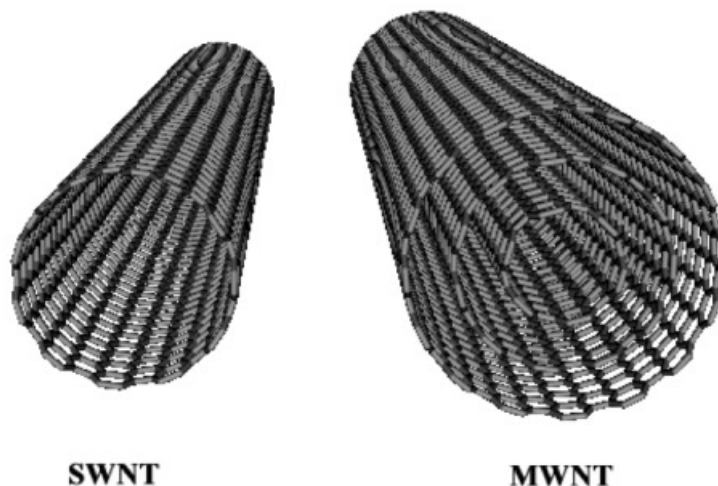

(from <http://www-ibmc.u-strasbg.fr/ict/vectorisation/nanotubes.shtml>)

## Interesting Properties

Carbon nanotubes are interesting both from a fundamental physical and aesthetic point of view and for their tremendous potential for practical applications. The large aspect ratio of single walled nanotubes, which are commonly  $\sim 1$  nm in diameter and microns in length, makes them both a fascinating pseudo-one dimensional system for the exploration of theoretical physicists and an appealing filler material for the design of high performance composites by materials engineers. Carbon nanotubes have the highest measured tensile strength of any material, measuring in the tens of GPa, while at the same time exhibiting an elastic modulus around a TPa. Their electrical resistivity can be as small as microOhms-cm and the thermal conductivity of carbon nanotubes is predicted to exceed diamond at thousands of W/m-K.

The attractive physical and chemical properties of carbon nanotubes continue to motivate research and development of nanotube materials, devices and applications in laboratories around the world. Though many reports have been published in the last decade of product and material performance enhancements due to carbon nanotubes relatively few commercial products including carbon nanotubes currently exist<sup>ii</sup>.

## Synthesis of Carbon Nanotubes

### Current Growth Methods

The three major methods used for commercial production of carbon nanotubes are the electric arc, the laser ablation, and the chemical vapor deposition methods<sup>iii</sup>. Each of these methods involves a carbon source and a heat source. The production of single wall carbon nanotubes involves higher

heat than the production of multi wall tubes and generally also requires a transition metal catalyst.

Arc discharge is the method that has been used for the large-scale synthesis of  $C_{60}$  molecules. It entails passing a sizeable current ( $>50A$ ) between two closely spaced ( $<1mm$  apart) graphite electrodes in an inert, low-pressure atmosphere. The high temperature ( $>3000C$ ) plasma created between the electrodes sublimes graphite from the anode. The vaporized carbon condenses, into nanotubes and other carbon forms, and deposits onto the cathode and surrounding apparatus. Metal catalyst is introduced into the process through incorporation into the anode. Single or bi-metallic mixtures of Co, Ni, Y, and Fe are used to achieve single wall nanotubes in yields as high as 90%.

The laser ablation method is similar to the electric arc discharge method, but uses a laser rather than resistive heating to vaporize the graphite carbon target. Metal catalyst and graphite powder may be formed into a target puck and the laser rastered across the surface of the rotated target in a flowing stream of inert gas. Condensed carbon, including nanotubes, may be collected downstream. Both the arc discharge and the laser ablation method consume their graphite targets during nanotube production and are thereby limited in their capacity for a continuous production mode. Additionally, these processes often require reduced pressures.

The chemical vapor deposition (CVD) method involves the catalytic decomposition of hydrocarbon in a furnace and can be performed at or near atmospheric pressure. A substrate may be coated or patterned with a catalyst or catalyst mixture (such as Co/Mo) and inserted into a furnace (such as a tube furnace). The furnace is heated to several hundred degrees Celsius, as high as  $900C$  or more for single wall nanotubes, and a hydrocarbon is flowed through the

furnace in a gas stream. Alternatively, the metal catalyst may be introduced via the gas stream such as by bubbling nitrogen through a ferrocene solution. Common carbon sources used for CVD carbon nanotube synthesis are acetylene, xylene, toluene, and ethanol. The hydrocarbons disassociate at metal catalyst sites and the activated carbon precursors form into nanotubes with the catalyst particle either at remaining at the base of the tube that grows out from it or at the tip of the growing tube. The carbon nanotubes grow directly onto the substrate surface and/or deposit in the furnace in the vicinity of the hot zone. A variation of the CVD method, called plasma enhanced chemical vapor deposition (PECVD), involves an electric field created at the substrate surface that aids in alignment of the carbon nanotubes. Reported versions of the CVD method include fixed bed, fluidized bed, aerosol, floating catalyst, and combinations of some of these with arc discharge or laser methods. Advantages of the CVD method include the ability to grow carbon nanotubes into patterns on surfaces, operation at atmospheric pressure, and the opportunity to produce carbon nanotubes in a continuous process. A disadvantage is that CVD grown carbon nanotubes have generally been of lower quality (higher defect content) than arc discharge or laser ablation grown tubes. Future advances in process parameter optimization may enable catalytic chemical vapor deposition to become a high throughput method for the production of high quality carbon nanotubes.

### *Nanotube Mixtures*

Current methods for production of carbon nanotubes result in a distribution of nanotube lengths, diameters, and chiralities. Since many of the carbon nanotube applications seek to take advantage of the inherent properties of only a subset of nanotube structures it is either necessary to perform separation processes to obtain only certain nanotube structures or to use the as-produced mixture of nanotubes and suffer the resulting attenuation in performance and efficiency. For example, one may desire semiconducting nanotubes from which to construct gas sensors and metallic nanotubes from which to form electrical interconnects. Short carbon nanotubes may be desirable for biomedical applications such as drug delivery, while long nanotube are needed to reach low percolation thresholds in electrically conductive composites.

Some success has been achieved in separation, or least relative enrichment, of carbon nanotube structural types using electrophoresis<sup>iv</sup>, density differentiation<sup>v</sup>, and preferential chemistry. These processes have been demonstrated on small scales—on the order of milligrams or less—and are laborious. One approach that has been proposed for achieving bulk quantities of carbon nanotubes of specific chirality is to separate nanotube types from an as-produced mixture and then use the individual species to seed

the growth of that specific type. This concept has been demonstrated in principle<sup>vi</sup>, but the successful implementation for achieving useable quantities of various nanotube types will require much additional development.

### **Atomically Precise Manufacturing of Carbon Nanotubes**

It is the predicted performance of pristine (perfect structure) carbon nanotubes for such applications as thermal and electrical conduction and mechanical reinforcement that has inspired much of their research and development. A major gap exists, however, between the properties of perfect (defect-free) individual carbon nanotubes and the properties of bulk materials and devices made from nanotubes. This disparity is a result of the difficulty in achieving defect-free carbon nanotubes of desired structure and the difficult in achieving ideal interfacing of individual nanotubes with each other and with other non-nanotube device components. For instance, individual single walled carbon nanotubes have been predicted to have a Young's (elastic) modulus of more than 1 TPa, while macroscopic fibers constructed from single walled nanotubes have an elastic modulus of only tens of GPa. The ability to construct carbon nanotubes atom by atom with atomic precision would enable the production of defect-free nanotubes of desired structure-determined properties. It may also facilitate the interfacing of atomically constructed nanotubes with each other and with electrodes, structural materials, etc. to construct devices based on carbon nanotubes that truly take advantage of desirable carbon nanotube properties.

### *Nanotube Structure*

The three most significant material composition issues with carbon nanotubes produced today are purity, quality and dispersity (variety of forms). The purity of nanotubes refers to the portion of a given carbon nanotube-containing sample that is not carbon nanotubes. Common impurities in as-produced carbon nanotube samples include residual metal catalyst, amorphous carbon and other fullerenes that are byproducts of the production process. The quality of the nanotubes, as defined here, is the degree to which they are free of defects. Defects include holes and/or kinks in the nanotube backbone structure and may involve rearrangement of the carbon hexagons into other polygons or addition of non-carbon atoms and functional groups at the sites of broken carbon-carbon bonds. The purification of carbon nanotube samples to remove residual metal catalyst and amorphous carbon, as currently practiced, usually induces defects in the structures of the purified nanotubes such as the opening of holes in the tube ends and walls and the addition of various oxidation products (hydroxyl groups, carboxylic acids, etc.) to the nanotube, thus reducing nanotube quality. Carbon nanotube samples available today, even if relatively

pure and of good quality, consist of a distribution of nanotube chiralities, diameters, and lengths.

The physical and chemical properties exhibited by a carbon nanotube material are strongly influenced by the purity, quality and diversity of the nanotubes that comprise the material. The ability to manufacture carbon nanotubes with atomic precision would overcome each of these hurdles and greatly facilitate carbon nanotube application. Atomically precise control of the cage structure (chirality) of carbon nanotubes would enable programming of electronic properties of nanotubes and the bandgap of each<sup>vii</sup>, important for optical, electronic and sensing applications. Since they are strongly dependent on nanotube structure this capability would similarly allow control over carbon nanotube chemical and physical reactivity, important for nanotube sorbent and catalysis applications. Willful determination of nanotube diameter and length could also be crucial for size-selective nanotube filtration membranes, conductive composites, and fiber reinforced composites. Arbitrary control of length would enable short nanotubes (<100nm) for drug delivery and extremely long carbon nanotubes (>100km) for unprecedented applications such as long haul electrical wiring and space elevators. In addition, software controlled atom-by-atom construction of carbon nanotubes could provide complex architectures such as a web of covalently bound wires<sup>viii</sup>, a network of nanometer-sized pipelines, or a highly porous, single molecule carbon framework<sup>ix</sup>. Inclusion of other components with atomic precision, such as metal atoms within the tubes, could enable new applications such as nanotube-based non-volatile memory.

### *Nanotube Integration*

A further challenge that has impeded the widespread commercial application of carbon nanotubes is the integration of the carbon structures into device and material architectures. Atomically precise fabrication of a carbon nanotubes might not only provide a way to build the desired type, form, and purity of nanotube, but also to optimally attach the constructed tube to such elements as contact electrodes and AFM cantilever tips to achieve the best electrical and/or mechanical continuity. This would enable such technologies as electrical monitoring of processes within living cells and topographical mapping of biomolecules. The wiring of integrated circuits, field effect transistor sensors, photovoltaic and fuel cell conduction paths with carbon nanotubes to achieve the highest efficiencies and performance would become possible with sub-nanometer control in the manufacture and placement of the device elements. Atomic stitching of proteins or receptor molecules selectively to the tip or sidewall of a single carbon nanotube device element would enable extreme sensing capabilities; down to individual analyte molecule levels. Atomic control of the chemical attachment

of various functional groups to carbon nanotubes could minimize damage to the nanotube structure while facilitating nanotube solubility, interfacing of nanotube fillers with matrix materials, and control over nanotube toxicity. Finally, precise control of the synthesis and positioning of carbon nanotube elements could conceivably enable the construction of nanotube-based molecular machinery including gears, bearings, etc. that take advantage of the atomic smoothness and mechanical strength of the carbon nanotube structure<sup>x</sup>.

### **Further Reading**

Professor David Tomanek's "The Nanotube Site" at <http://www.pa.msu.edu/cmp/csc/nanotube.html>

Realistic applications of CNTs. J. Robertson *Materials Today* October 2004 46-52

Carbon Nanotubes—the Route Toward Applications. R.H. Baughman, A. Zakhidov, W.A. de Heer *Science* 2002 297 787-792

Characterization methods of carbon nanotubes: a review T. Belin and F. Epron *Mater Sci Eng B* 2005 119 105-118

Carbon Nanotubes: Synthesis, Integration, and Properties H. Dai *Acc Chem Res* 2002 35(12) 1035-1044

Single-Walled Carbon Nanotubes: from Fundamental Studies to New Device Concepts. T.W. Odom, J.-L. Huang, C.M. Lieber *Ann NY Acad Sci* 2002 960 203-215

---

<sup>i</sup> S. Iijima "Helical Microtubules of Graphitic Carbon" *Nature* 1991 354(6348): 56-58.

<sup>ii</sup> Walt A. de Heer "Nanotubes and the Pursuit of Applications" *MRS Bull* April 2004 281-285

<sup>iii</sup> C.H. See and A.T. Harris "A Review of Carbon Nanotube Synthesis via Fluidized-Bed Chemical Vapor Deposition" *Ind. Eng. Chem. Res.* 2007, 46, 997-1012; C.E. Baddour and C. Briens "Carbon Nanotube Synthesis: A Review" *Intrnl. J. Chem. Reactor Eng.* 2005 3(R3) 1-20; C. Journet and P. Bernier "Production of carbon nanotubes" *Appl Phys A* 1998 67 1-9

<sup>iv</sup> R. Krupke, F. Hennrich, H. Lohneisen, M.M. Kappes "Separation of Metallic from Semiconducting Single-Walled Carbon Nanotubes" 2003 *Science* 301(5631): 344-347; W.-J. Kim, M.L. Usrey, M.S. Strano "Selective Functionalization and Free Solution Electrophoresis of Single-Walled Carbon Nanotubes: Separate Enrichment of Metallic and Semiconducting SWNT" *Chem Mater* 2007 19 1571-1576



---

<sup>v</sup> M.S. Arnold, A.A. Green, J.F. Hulvat, S.I. Stupp, M.C. Hersam "Sorting carbon nanotubes by electronic structure using density differentiation" *Nature Nanotechnology* 1 (1): 60-65 OCT 2006; Zheng M, Semke ED "Enrichment of single chirality carbon nanotubes" *J. Am. Chem. Soc.* 2007 129 (19): 6084-6085

<sup>vi</sup> R.E. Smalley, Y. Li, V.C. Moore, B.K. Price, R. Colorado, H.K. Schmidt, R.H. Hauge, A.R. Barron, J.M. Tour "Single Wall Carbon Nanotube Amplification: En Route to a Type-Specific Growth Mechanism." *J. Am. Chem. Soc.* 2006 128(49): 15824-15829.

<sup>vii</sup> G.P. Miller, S. Okano, D. Tomanek "Toward uniform nanotubular compounds: Synthetic approach and ab initio calculations." *J. Chem. Phys.* 2006 124(12): 121102/1-121102/5.

<sup>viii</sup> R.H. Baughman, D.S. Galvao, C.X. Cui, Y. Wang, D. Tomanek "Fullerenynes - a New Family of Porous Fullerenes." *Chem. Phys. Lett.* 1993 204(1-2): 8-14.

<sup>ix</sup> K. Umemoto, S. Saito, S. Berber, D. Tomanek "Carbon foam: Spanning the phase space between graphite and diamond." *Phys. Rev. B* 2001 64(19).

<sup>x</sup> K.E. Drexler *Nanosystems: Molecular Machinery, Manufacturing, and Computation* 1992 Wiley





## Single-Walled Carbon Nanotubes

Single-walled carbon nanotubes (SWNTs) have been at the forefront of novel nanoscale investigations due to their unique structure-dependent electronic and mechanical properties. They are thought to have a host of wide-ranging, potential applications including as catalyst supports in heterogeneous catalysis, field emitters, high strength engineering fibers, sensors, actuators, tips for scanning probe microscopy, gas storage media, and as molecular wires for the next generation of electronics devices. The combination of the helicity and diameter of SWNTs, defined by the roll-up vector, determines whether a tube is a metal or a semiconductor. Moreover, the mechanical strength of a tube is a function of its length and diameter. SWNTs have been synthesized in our lab, in gram quantities, by means of a chemical vapor deposition process although other methods including arc discharge and laser vaporization exist for generating these materials. Indeed, the advantage of SWNTs is that they are chemically, molecularly defined structures with reproducible dimensions.

Many applications utilizing SWNTs require chemical modification of the carbon nanotubes to make them more amenable to rational and predictable manipulation. For example, the generation of high strength fibers is associated with the individualization of nanotubes and their subsequent dispersion into a polymer matrix. Moreover, the requirements of load-transfer efficiency demand that nanotube surfaces should be compatible with the host matrix. Secondly, sensor applications involve the tethering onto nanotube surfaces of chemical moieties with specific recognition sites for analytes with ensuing triggering of a predictable response in the nanotube's optical or transport properties. Thirdly, gas storage and lithium intercalation applications necessitate the opening of hollow cavities in nanotube sidewalls. To fulfill all of these varied stipulations at the nanoscale requires an intimate and precise understanding of the chemistry and functionality of carbon nanotubes, such as would be offered by atomically precise manufacturing.

The main problem with the majority of popular synthetic methods for growing SWNTs (i.e., laser ablation, arc-discharge, and chemical vapor deposition) is that they produce samples yielding a mixture of many different diameters and chiralities of nanotubes that are moreover contaminated with metallic and amorphous impurities. Thus, post-synthesis chemical processing protocols, that purify tubes and that can also separate individual tubes according to diameter and chirality by taking advantage of their intrinsically differential reactivity, are often the only viable routes towards rational and predictable manipulation of the favorable electronic and mechanical properties of these materials. APM would certainly be viewed as an alternative route towards practically achieving these goals.

From a fundamental scientific perspective, chemical functionalization and APM allow for the exploration of the intrinsic molecular nature of these SWNTs and permit studies at the rich, structural interface between true molecules and bulk materials. In general, chemical modification strategies have targeted SWNT defects, end caps, sidewalls, as well as the hollow interior. APM would allow for an even more highly focused chemical targeting of nanomaterials. Representative approaches to nanotube derivatization include covalent chemistry of conjugated double bonds within the SWNT, non-covalent  $\pi$ -stacking, covalent interactions at dangling functionalities at nanotube ends and defects, and wrapping of macromolecules. Chemical functionalization of SWNTs attached to conventional atomic force microscopy probes has also been demonstrated as a methodology of yielding high-resolution, chemically-sensitive images on samples containing multiple chemical domains. In this last case, functionalization can be spatially localized at nanotube ends, often involving only a few molecules.

Thus, rational SWNT functionalization as well as APM provide for the possibility of the manipulation of SWNT properties in a predictive manner. The surface chemistry of SWNTs plays a vital role in enabling the dispersability, purification, solubilization, diameter and chirality-based separation, and biocompatibility of these unique nanostructures. In addition, derivatization allows for a number of site-selective nanochemistry applications such as the self-assembly of nanotubes with tailorable electronic properties, important for advances in molecular electronics. Other derivatized SWNT adducts show potential as catalytic supports and as biological transport vessels. Moreover, these systems often demonstrate novel charge transfer characteristics, the development and understanding of which have implications for photocatalysis and energy storage. Finally, rational chemical manipulation of SWNTs is critical for the hierarchical build-up of these nanomaterials into functional architectures, such as nanocomposites and nanocircuits, with unique properties.



## Oligomer with Cavity for Carbon Nanotube Separation

### Criteria

The proposed technology is a protein macromolecule capable of selective interaction with carbon nanotubes. The protein consists of several identical subunits that can spontaneously assemble into a ring structure with a well-defined cavity size. Only in the presence of a carbon nanotube with a specific diameter and chirality do the subunits assemble into the ring. Attached to the protein subunits are magnetic beads which can be used to fish out proteins bound to carbon nanotubes. Nanotube-bound subunits can be separated from unbound subunits based on how magnetic they are since multiple subunits will be bound to a single nanotube (forming a ring and possibly with several rings bound to a single nanotube) or can be separated based on size. The design will be based on existing ring structures found in Nature.

### Metrics

A successful implementation of the technology will be measured by a number of metrics. A successful implementation can distinguish between nanotubes with diameters differing on the order of a few Angstrom. The protein must also be able to distinguish between nanotubes with different chirality and should only bind to nanotubes with a selected chirality. While this is a very challenging goal a more modest implementation can distinguish chiral from non-chiral nanotubes. The affinity for binding to the nanotube must be tuned such that a single subunit cannot bind alone but require the accumulated interactions in the ring to bind.

It is also required, although it may not be an absolute requirement that the proteins do not self-assemble into rings in the absence of nanotubes of the right size and chirality. Proteins designed to bind to hydrophobic substances must expose hydrophobic patches on the surface of the protein that are used for interaction. This often leads to non-specific aggregation preventing production and selectivity of binding. A successful protein design will have to avoid this behaviour.

### Enablers for the Technology

To develop the proposed technology a number of developments have to occur. The field of protein design has progressed rapidly in the last 15 years. There have been a number of approaches: evolutionary, rational and computational protein design. Evolutionary approaches mimics the evolutionary processes used by Nature to develop novel protein function. The method uses random drift and recombination to maximize a designed property. It

is a mature technology but is presently only useful for fine-tuning. Rational design uses general design principles derived from the study of naturally occurring proteins and previously tested designs. It is time-consuming, difficult and requires a lot of experience. Computational protein design is the most promising approach. It uses a physical model of protein energetics together with conformational sampling to generate protein designs. Computational protein design has previously been used to create proteins with novel folds, to change specificity of protein-protein and protein-DNA interfaces and to design novel enzymes. However, the creation of novel protein-protein or protein-material interfaces has not been demonstrated yet. The design of novel interfaces between protein and carbon surfaces requires the development of a physical description of the carbon surface together with an accurate energy function. In order to routinely design new binding interfaces better energy functions describing the protein and more efficient methods for conformational sampling must be developed. Since the ring structure will have cyclical symmetry methods for symmetrical design will have to be developed. Separation of proteins with magnetic beads is routinely used.

### What the Technology Enables

Future applications of biotechnology and nanotechnology will depend on the development of technology to couple biomaterials with other materials. Different macromolecules have different strengths and drawbacks. Proteins in biological systems are the most complex examples of functional nanotechnology and present a diverse toolset with which very complex problems can be attacked. But proteins are optimized for the biological context and do not have the blueprint for every problem anticipated in the future development of nanotechnology. Computational protein design has the promise to drive the development of protein systems with properties not found in nature. However, other materials and macromolecules have superior properties for some applications. It is of great value to have access to methods to couple biomaterials with other materials. The described technology couples proteins with carbon nanotubes which among other things have very interesting electronic properties not found in proteins. An obvious extension of the technology is the binding of proteins to Buckminster fullerenes. The technology can also enable methods to couple proteins to different types of inorganic surfaces.

### Applications

Carbon nanotubes are cylindrical carbon molecules with a number of physical properties that make them ideally suited for nanotechnology. They consist of a single layer of

graphite, called graphene, wrapped around to form a cylinder. The diameter of single-walled nanotubes is close to 1 nm while the length can be thousands of times larger. The high aspect ratio and the  $sp^2$  hybridization of the carbon-carbon bonds make them extremely strong with the highest specific strength of known materials. Nanotubes are expected to have asymmetric thermal properties with very high conductivity along the tube and functioning as insulators across the tube axis. Nanotubes can either be metallic or semiconducting depending on the precise atomic structure. Due to their small dimensions and unusual conduction mechanism they are believed to be the prime candidate for the creation of nanoelectronics and have received considerable interest in the semiconductor industry.

Carbon nanotubes are currently produced by arc discharge, laser ablation or chemical vapour deposition. Creation of nanodevices based on nanotubes requires the

control of the precise properties such as the atomic structure and dimensions. Current production techniques does not allow for the production of homogenous single-walled nanotubes. Carbon nanotubes can have a number of atomic structures which control the diameter and electronic properties. The atomic structure is defined by a vector in an infinite graphene sheet that describes how to roll it up into a nanotube. Most carbon nanotubes are chiral and it would be of considerable interest to produce homogenous nanotubes of selected chirality.



## Nanoparticle Synthesis

This manuscript has been authored by Battelle Energy Alliance, LLC under Contract No. DE-AC07-05ID14517 with the U.S. Department of Energy. The United States Government retains and the publisher, by accepting the article for publication, acknowledges that the United States Government retains a nonexclusive, paid-up, irrevocable, world-wide license to publish or reproduce the published form of this manuscript, or allow others to do so, for United States Government purposes.

### Background

Nanoparticles are commonly defined as particles less than 100 nm in diameter. Due to this small size, nanoparticles have a high surface-to-volume ratio. This increases the surface energy compared to the bulk material. The high surface-to-volume ratio and size effects (quantum effects) give nanoparticles distinctively chemical, electronic, optical, magnetic and mechanical properties from those of the bulk material. Nanoparticles synthesis can be grouped into three broad approaches. The first one is gas-phase synthesis (aerosol), the second is wet phase synthesis (sol-gel processing), and the third is mechanical attrition. The properties of the final product may differ depending on the fabrication route.

The aerosol methods for production of material particles can be divided into the gas-to-particle and the liquid/solid-to-solid routes. In the liquid/solid-to-solid route the product particles are formed from droplets of reactant particles via intraparticle reactions. Using this method it is possible to produce single and multicomponent materials of controlled homogeneous compositions. It is a continuous process that can be scaled up. However, this is a complicated technique since many different physical and chemical phenomena (e.g. evaporation of the solvent, chemical reactions) can occur simultaneously. The gas-to-particle route is a common method when nanoparticles are produced through gas phase processes. In this route, particles nucleated from a supersaturated vapor. Supersaturation can be achieved by physical processes such as cooling of a hot vapor or through chemical reactions of gaseous precursors, which results in the formation of condensable species. Very small particles on the order of nanometers can be produced and the final products often have high purity. However, the production rates may be low in some processes and multicomponent materials may be difficult to produce. There may also be problems with hazardous reactants and by-products.

Varying the process conditions, e.g., the initial concentration of precursor, maximum temperature, residence time and cooling rate, can control the degree of agglomeration of the synthesized nanoparticles. In the gas-to-particle synthesis there are two routes, physical and chemical, depending on how the vapor supersaturation needed for particle nucleation comes about. However, these processes are identical in terms of the aerosol dynamics that occurs once the condensable species have formed. In the

physical vapor process, the solid precursor and the final product are the same material. This route is simple since no chemical reactions occur in the gas phase. However, temperatures high enough to vaporize the precursor are needed and this limits the materials that can be processed. In general the yield in physical vapor condensation of nanoparticles tends to be low. In the chemical vapor route, the production rates can be significant if a precursor with high volatility is available. Therefore, chemicals such as metal chlorides or metalorganic compounds are often used, for example, titania is produced on an industrial scale from  $\text{TiCl}_4$  using this method. However, in using metal chlorides or metalorganic compounds there is a possible risk of contaminating the final product. Composite particles can be produced, using the chemical vapor route.

Recently, smaller nanoparticles ranging from 1 to 10 nm with consistent crystal structure, specific surface structures or properties, and a tight particle size distribution have been produced by both gas-phase and sol-gel techniques. The particles produced by these processes have typical size variances of about 20%. However, for measurable enhancement of the quantum effect, the size variances must be reduced to less than 5% [Ref. 1].

Initial development of new crystalline materials was based on nanoparticles generated by evaporation and condensation (nucleation and growth) in a subatmospheric inert-gas environment [Refs. 2, 3, 4]. Various aerosol processing techniques have been reported to improve the production yield of nanoparticles [Refs. 5, 6]. These include synthesis by combustion flame [Refs. 7, 8, 9,10]; plasma [Ref. 11]; laser ablation [Ref. 12]; chemical vapor condensation [Ref. 13]; spray pyrolysis [Ref. 14]; electrospray [Ref. 15]; and plasma spray [Ref. 16].

Sol-gel processing is a wet chemical synthesis approach that can be used to generate nanoparticles by gelation, precipitation, and hydrothermal treatment [Ref. 17]. Size distribution of semiconductor, metal, and metal oxide nanoparticles can be manipulated by either dopant introduction [Ref. 18] or heat treatment [Ref. 19]. Better size and stability control of quantum-confined semiconductor nanoparticles can be achieved through the use of inverted micelles [Ref. 20], polymer matrix architecture based on block copolymers [Ref. 21] or polymer blends [Ref. 22], porous glasses [Ref. 23], and ex-situ particle-capping techniques [Refs. 24, 25].

Additional nanoparticle synthesis techniques include sonochemical processing, cavitation processing, microemulsion processing, and high-energy ball milling. In sonochemistry, an acoustic cavitation process can generate a transient localized hot zone with extremely high temperature gradient and pressure [Ref. 26]. Such sudden changes in temperature and pressure assist the destruction of the sonochemical precursor (e.g., organometallic solution) and the formation of nanoparticles. The technique can be used to produce a large volume of material for industrial applications.

In hydrodynamic cavitation, nanoparticles are generated through creation and release of gas bubbles inside the sol-gel solution [Ref. 27]. By rapidly pressurizing in a supercritical drying chamber and exposing to cavitation disturbance and high temperature heating, the sol-gel solution is mixed. The erupted hydrodynamic bubbles are responsible for nucleation, growth, and quenching of the nanoparticles. Adjusting the pressure and the solution retention time in the cavitation chamber can control particle size.

Microemulsions have been used for synthesis of metallic [Ref. 28], semiconductor [Refs. 29, 30], silica [Ref. 31], magnetic, and superconductor nanoparticles [Ref. 32]. By controlling the very low interfacial tension ( $\sim 10^{-3}$  mN/m) through the addition of a cosurfactant (e.g., an alcohol of intermediate chain length), these microemulsions are produced spontaneously without the need for significant mechanical agitation. The technique is useful for large-scale production of nanoparticles using relatively simple and inexpensive hardware [Ref. 33].

Finally, high energy ball milling (mechanical attrition), the only top-down approach for nanoparticle synthesis, has been used for the generation of magnetic [Ref. 34], catalytic [Ref. 35], and structural nanoparticles [Ref. 36]. The technique, which is already a commercial technology, has been considered dirty because of contamination problems from ball-milling processes. However, the availability of tungsten carbide components and the use of inert atmosphere and/or high vacuum processes have reduced impurities to acceptable levels for many industrial applications. Common drawbacks include the low surface area, the highly polydisperse size distributions, and the partially amorphous state of the as-prepared powders.

## Monodispersed Nanoparticles

One of the most challenging problems in synthesis is the controlled generation of monodispersed nanoparticles with size variance so small that size selection by centrifugal precipitation or mobility classification is not necessary. Among all the synthesis techniques discussed above, gas-phase synthesis is one of the best techniques with respect to size monodispersity, typically achieved by using a combination of rigorous control of nucleation-condensation

growth and avoidance of coagulation by diffusion and turbulence as well as by the effective collection of nanoparticles and their handling afterwards.

Plasma gas-phase (chemical and physical) synthesis has the best potential to produce nanoparticles with a narrow and tight size distribution in a very short time. More attention should focus in plasma gas-phase synthesis technology development. Collecting the nanoparticles in liquid suspension can ensure the stability of the collected nanoparticle powders against agglomeration, sintering, and compositional changes. New approaches need to be developed for the generation of monodisperse nanoparticles that do not require the use of a size classification procedure.

## Scale-Up

Scale-up production is of great interest for nanoparticle synthesis. High-energy ball milling, already a commercial high-volume process, as mentioned above, has been instrumental in generating nanoparticles for the preparation of magnetic, structural, and catalytic materials. However, the process produces polydispersed amorphous powder, which requires subsequent partial recrystallization before the powder is consolidated into nanostructured materials. For sol-gel processing, the development of continuous processing techniques based on present knowledge of batch processing has yet to be addressed for economical scale-up production of nanoparticles. Other related sol-gel issues concern the cost of precursors, the recycling of solvents, and the disposal of hazardous byproducts. Overall, sol-gel processing may still be attractive for commercial scale-up development. Although gas-phase synthesis is generally a low production rate process (typically in the 100 milligrams per hour range) in research laboratories, higher rates of production (about 20 grams per hour) are being demonstrated at Uppsala University in Sweden.

## Technology Development Need

To achieve wide spread applications for nanoparticles low cost and high rate commercial production processes must be developed. Among all the alternative processes discussed above thermal plasma technology has the best potential for low cost large scale gas-phase production of nanoparticles. Thermal plasma chemical vapor synthesis of nanoparticles presents no significant technical barriers however; the cost associated with chemical vapor synthesis would be high and high vapor pressure reactants are limited. Thermal plasma physical vapor deposition for nanoparticle synthesis should be a much lower cost production process but it does have significantly technical barrier issues. The technical barriers include short residence time, small high temperature processing zone, and uniform high temperature field. Technology development must overcome these technical barriers to make thermal plasma physical vapor synthesis a

truly viable low cost commercial nanoparticle production technology.

Recently, researchers at the Idaho National Laboratory engaged in new plasma reactor systems research to address the technical barriers for large-scale low cost thermal plasma physical vapor deposition of nanoparticles. The plasma reactor system is based on a modular unit concept. The modular plasma concept provides a long residence time, large high temperature processing zone, and a uniform high temperature field to completely vaporize large powder feed and to nucleate nanoparticles from the gas phase. In this new reactor concept one has control over the length, size of the processing zone, and the feed material residence time in the plasma by adding or removing modular plasma units in the reactor. For a traditional plasma reactor the residence time of feed material in the high-temperature processing zone is typically a couple of milliseconds. In this modular reactor system the residence time of feed material in the high-temperature processing zone can be several factors to orders of magnitude higher than a traditional plasma reactor. There

is also a cascading plasma energy loading effect to the downstream modular units thus increasing the available plasma energy content for the last modular unit to complete material processing.

Figure 1 shows the cutaway view of a 3-stage AC/AC modular hybrid plasma reactor for physical vapor deposition of nanoparticles. The schematic shows the cascading energy loading effect in the plasma reactor. The net plasma energy content cascading from the modular unit above will be increased by superimposition of an arc discharge into the plasma thus raising the total energy content. This higher net energy loading effect improves plasma ionization in the downstream modular units and increases the size of the plasma. The approximate temperature profile for this new plasma reactor is also depicted in Figure 1. This very long high temperature profile facilitates the vaporization of extremely refractory materials. One can exercise control of the feed material residence time by adding or removing modular plasma units.

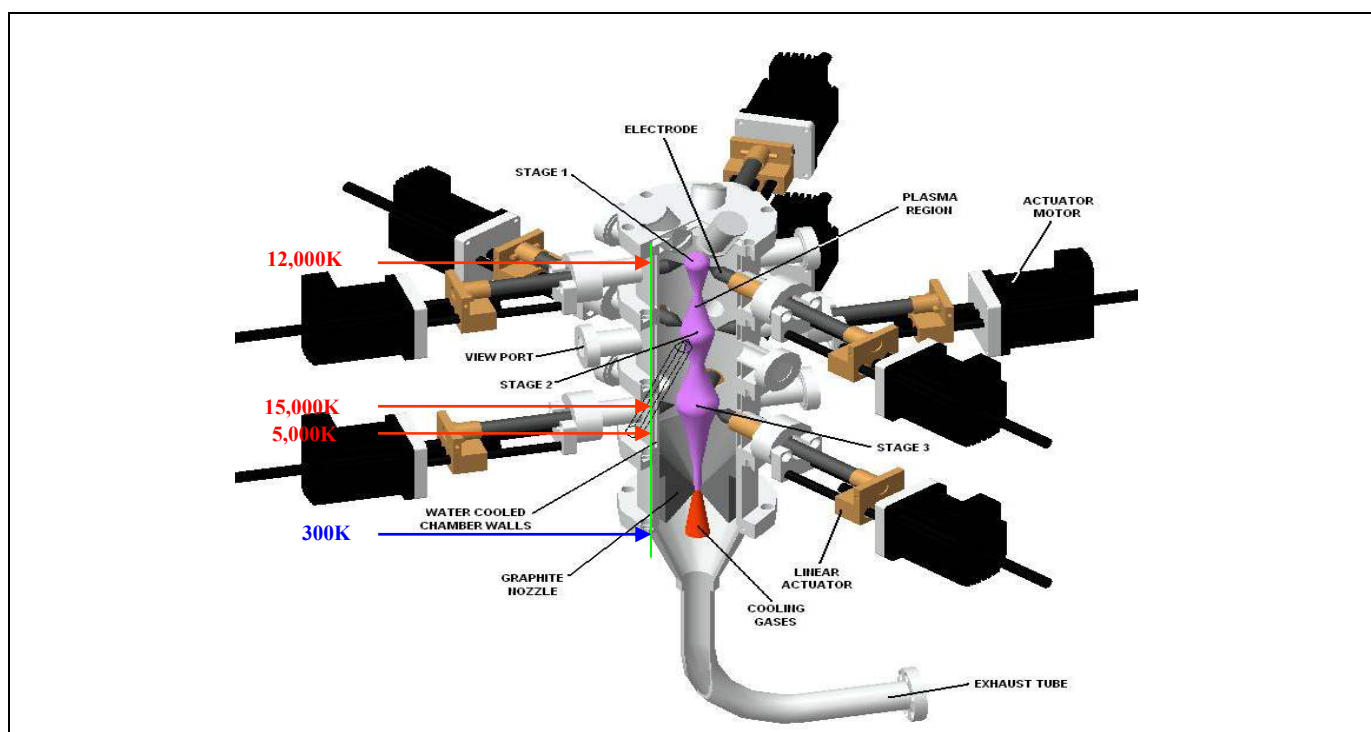

**Figure 1. Modular AC/AC hybrid plasma reactor.**

Another feature of this new reactor is that the plasma gas flow is very soft compare to traditional plasma jet reactors. A softer plasma flow also enhances the residence time of the feed material in the high-temperature processing zone. A very long residence time, and a large and uniform high temperature processing zone allows one to process feed powders up to a couple of hundred microns to produce nanoparticles in a rather small and compact reactor.

Figure 2 shows the 3-stage AC/AC modular hybrid plasma reactor in operation. The reactor operates at a total combined power of about 15 kW. This reactor had demonstrated its capability of vaporizing 150+ micron alumina and large silica feed particles. Figure 3 shows the TEM morphology of alumina nanoparticles produced using the modular AC/AC hybrid plasma reactor. Based on TEM electron diffraction analysis, both single crystallites and polycrystalline particles are present in the product powder.



Two types of nanoparticle morphologies are clearly identifiable. The single nanocrystallites are faceted showing well-formed crystal planes or habits. The well-formed single nanocrystallite has precise atomic compositions and formed by a heterogeneous vapor phase to solid phase nucleation process. The remaining powders are spherical polycrystalline nanoparticles and show no specific habits. These particles are most likely formed from a homogeneous vapor-liquid-solid condensation mechanism. X-ray analysis of the product nanopowder shows a single-phase polycrystalline  $\alpha$ -alumina. Silica nanoparticles were also produced in this reactor using large silica feed particles. Almost 98% of the particles produced are below 25 nm.

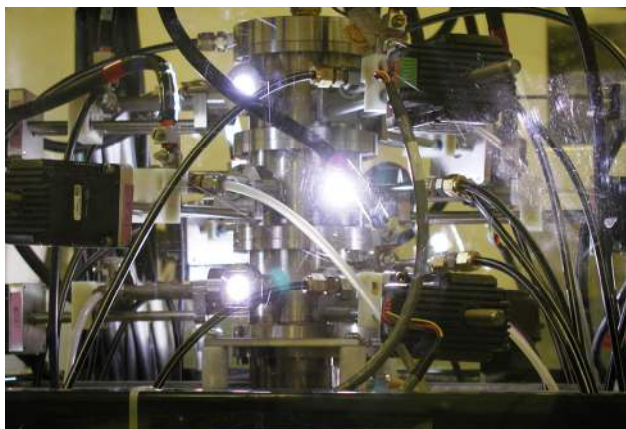

**Figure 2. Modular AC/AC hybrid plasma reactor in operation (US Patent 7232975, June 2007).**

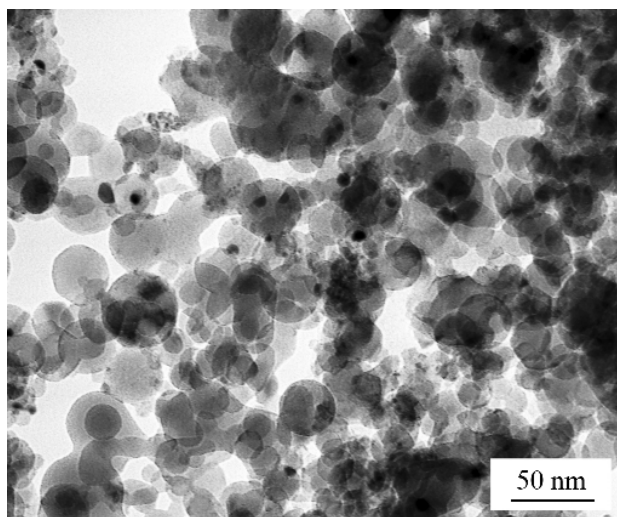

**Figure 3. Alumina nanoparticles produced from 150+ micron feed powder using the modular AC/AC hybrid plasma reactor.**

As shown in Figure 4, the silica nanoparticles produced have a tight particle size distribution. Figure 4 insert shows the TEM morphology of the silica nanoparticles. Unlike the alumina nanoparticles these particles are completely spherical and showed no faceted habits. Electron diffraction shows a complete amorphous material. The silica nanoparticle is formed by a vapor-liquid-solid condensation mechanism. X-ray diffraction confirms the amorphous nature of the silica. The amorphous silica nanoparticles have a high probability of imperfections that may lead to atomically imprecise surfaces. These atomically imprecise surfaces could have unusual material properties that may lead to unusual applications.

Thermal plasma exhibits a very high intrinsic quench rate that is responsible for the formation of nanoparticles. High intrinsic quench rate coupled with external quenching techniques will produce a super-fast quenching of the high temperatures in thermal plasma. In principle, a plasma super-fast quench process could freeze nascent nuclei from the gas phase. These nascent nuclei may be sub-nano material clusters that resemble the chemical composition make up of the product. These nascent nuclei may have atomically precise structure or compositions. Due to the conditions of formation these nascent nuclei clusters may contain quench in defects such as quench-in stress. The defects may alter the atomic composition or structure of the clusters leading to imperfect surfaces. Imperfect surfaces would not have atomically precise structures and are less stable than atomically precise structure, and could have unusual properties that may lead to unusual applications or processing conditions. For example, nanoparticles have very large surfaces and a very high amount of excess surface free energy. This high excess surface free energy is the driving force for low temperature consolidation of nanoparticles to full density while maintaining the nano-grain structure in the consolidated bulk material. Boron carbide, the atomically precise or perfect composition affects its ballistic properties significantly. Even a very slight deviation from the 4:1 B to C ratio degrades the ballistic performance of a boron carbide armor plate to a less desirable level. The properties of atomically precise or imprecise surfaces in nanoparticles have not been fully realized and exploited. Fundamental research in this area to understand these properties and their applications needs attention.

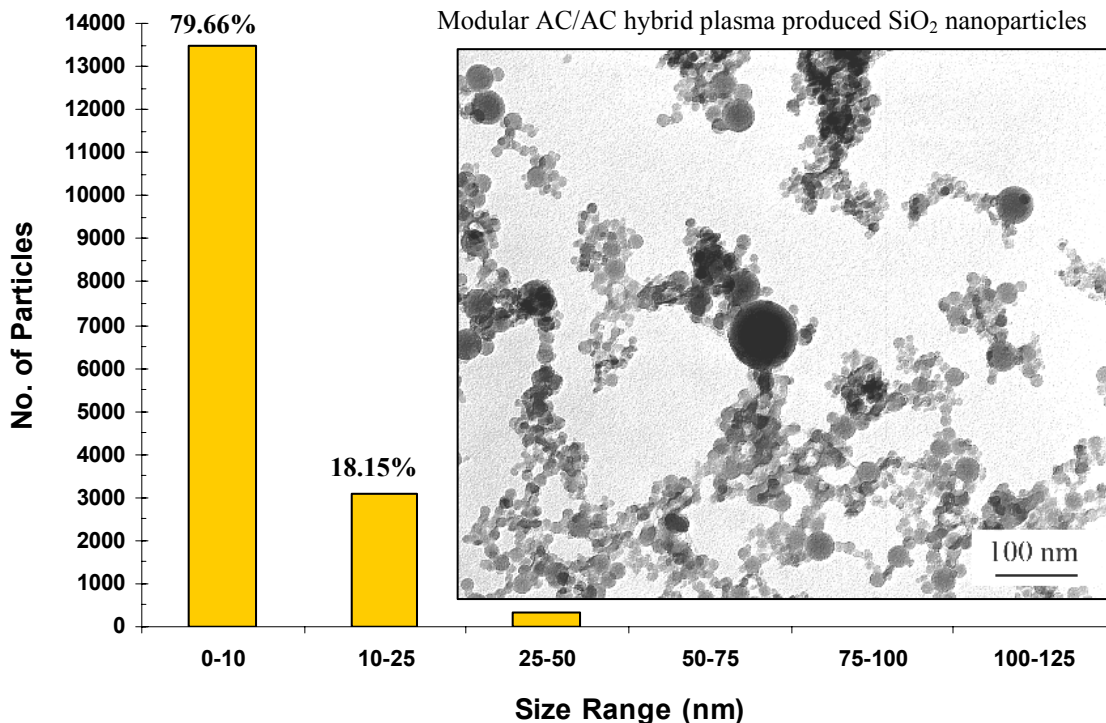

**Figure 4. Silica nanoparticle size distribution and TEM morphology.**

## References

- Murray, C. B., D. J. Norris, and M. G. Bawendi. 1993. *J. Am. Chem. Soc.* 115:8706.
- Gleiter, H. 1989. *Prog. Mater. Sci.* 33:223.
- Siegel, R. W. 1991. *Ann. Rev. Mater. Sci.* 21:559.
- Siegel, R. W. 1994. *Physics of new materials*. F.E. Fujita (ed.), Springer Series in Materials Science, Vol. 27, Berlin: Springer.
- Uyeda, R. 1991. *Prog. in Mater. Sci.* 35:1.
- Friedlander, S. K. 1998. Synthesis of nanoparticles and their agglomerates: aerosol reactors. In *R&D status and trends*, ed. Siegel et al.
- Calcote, H. F., and D. G. Keil. 1997. Combustion synthesis of silicon carbide powder. In *Proc. of the Joint NSF-NIST Conf. on Nanoparticles*.
- Axelbaum, R. L. 1997. Developments in sodium/halide flame technology for the synthesis of unagglomerated non-oxide nanoparticles. In *Proc. of the Joint NSF-NIST Conference on Nanoparticles: Synthesis, Processing into Functional Nanostructures and Characterization* (May 12-13, Arlington, VA).
- Pratsinis, S. E. 1997. Precision synthesis of nanostructured particles. In *Proc. of the Joint NSF-NIST Conf. on Nanoparticles*.
- Rao, N. P., N. Tymiak, J. Blum, A. Neuman, H. J. Lee, S. L. Girshick, P. H. McMurry, and J. Heberlein. 1997. Nanostructured materials production by hypersonic plasma particle deposition. In *Proc. of the Joint NSF-NIST Conf. on Nanoparticles*.
- Becker, M. F., J. R. Brock, H. Cai, N. Chaudhary, D. Henneke, L. Hilsz, J. W. Keto, J. Lee, W. T. Nichols, and H. D. Glicksman. 1997. Nanoparticles generated by laser ablation. In *Proc. of the Joint NSF-NIST Conf. on Nanoparticles*.
- Kear, B. H., R. K. Sadangi, and S. C. Liao. 1997. Synthesis of WC/Co/diamond nanocomposites. In *Proc. of the Joint NSF-NIST Conf. on Nanoparticles*.
- Messing, G. L., S. Zhang, U. Selvaraj, R. J. Santoro, and T. Ni. 1994. Synthesis of composite particles by spray pyrolysis. In *Proc. of the Joint NSF-NIST Conf. on*



- Ultrafine Particle Engineering* (May 25-27, Arlington, VA).
- 15 de la Mora, J. F., I. G. Loscertales, J. Rosell-Llompert, K. Serageldin, and S. Brown. 1994. Electrospray atomizers and ultrafine particles. In *Proc. Joint NSF-NIST Conf. on UltraFine Particle Engineering* (May 25-27, 1994, Arlington, VA).
- 16 Berndt, C. C., J. Karthikeyan, T. Chraska, and A. H. King. 1997. Plasma spray synthesis of nanozirconia powder. In *Proc. of the Joint NSF-NIST Conf. on Nanoparticles*.
- 17 Kung, H. H., and E. I. Ko. 1996. *Chem. Eng. J.* 64:203.
- 18 Kyprianidou-Leodidou, T., W. Caseri, and V. Suter. 1994. *J. Phys. Chem.* 98:8992.
- 19 Wang, C. C., Z. Zhang, and J. Y. Ying. 1997. *Nanostructured Mater.* 9:583.
- 20 Gacoin, T., L. Malier, and J. P. Boilot. 1997. *Chem. Mater.* 9:1502.
- 21 Sankaran, V., J. Yue, R. E. Cahen, R. R. Schrock, and R. J. Silbey. 1993. *Chem. Mater.* 5:1133.
- 23 Justus, B. L., R. J. Tonucci, and A. D. Berry. 1992. *Appl. Phys. Lett.* 61:3151.
- 24 Majetich, S. A. and A. C. Canter. 1993. *J. Phys. Chem.* 97:8727.
- 25 Olshavsky, M. A., Allcock, H. R. 1997. *Chem. Mater.* 9:1367.
- 26 Suslick, K. S., T. Hyeon, and F. Fang. 1996. *Chem. Mater.* 8:2172.
- 27 Sunstrom, J. E., IV, W. R. Moser, and B. Marshik-Guerts. 1996. *Chem. Mater.* 8:2061.
- 28 Kishida, M., T. Fujita, K. Umakoshi, J. Ishiyama, H. Nagata, and K. Wakabayashi. 1995. *Chem. Commun.* 763.
- 29 Kortan, A. R., R. Hull, R. L. Opila, M. G. Bawendi, M. L. Steigerwald, P. J. Carroll, and L. E. Brus. 1990. *J. Am. Chem. Soc.* 112:1327.
- 30 Pileni, M. P., L. Motte, and C. Petit. 1992. *Chem. Mater.* 4:338.
- 31 Arriagada, F. J., and K. Osseo-Asave. 1995. *J. Colloid Interface Sci.* 170:8.
- 32 Pillai, V., P. Kumar, M. J. Hou, P. Ayyub, and D. O. Shah. 1995. *Adv. in Colloid and Interface Sci.* 55:241.
- 33 Higgins, R. J. 1997. An economical process for manufacturing of nano-sized powders based on microemulsion-mediated synthesis. In *Proc. of the Joint NSF-NIST Conf. on Nanoparticles*.
- 34 Leslie-Pelecky, D. L., and R. D. Reike. 1996. *Chem. Mater.* 8:1770.
- 35 Ying, J. Y., and T. Sun. 1997. Research needs assessment on nanostructured catalysts. *J. of Electroceramics* 1:219-238.
- 36 Koch, C. C. 1989. Materials synthesis by mechanical alloying. *Annual Review of Mater. Sci.* 19:121-143.

## Metal Oxide Nanoparticles

Nanoscience is associated with the intimate understanding and control of matter at dimensions of roughly 1 to 100 nm and is intrinsically important because of the genuine expectation that the properties of materials at this scale will differ significantly from those of their bulk counterparts. Nanotechnology involves the imaging, measuring, modeling, and manipulation of materials at this length scale. We note that the term, 'materials', appears in both of these conceptual definitions. It follows that the synthesis and fabrication of functional nanomaterials with predictive, rational strategies is a major, focal point of research of many groups worldwide.

In practice, this effort has entailed the design, production, and characterization of a myriad of nanostructures including nanoparticles, nanocubes, nanorods, nanowires, and nanotubes, which maintain fundamentally interesting size-dependent electronic, optical, thermal, mechanical, magnetic, chemical, and other physical properties. From the perspective of applications, these structures have wide-ranging utility in areas as diverse as catalysis, energy storage, fiber engineering, fuel cells, biomedicine, computation, power generation, photonics, photovoltaics, transparent conductive films, pollution remediation, and sensing.

Metal oxides, in particular, represent one of the most diverse classes of materials, with important structure-related properties, including superconductivity, ferroelectricity, magnetism, colossal magnetoresistivity, conductivity, and gas sensing capabilities. It is evident that the precise synthesis of metal oxide nanostructures will lead to key developments in the construction of devices.

Specifically, comparatively little work has been performed on the fabrication of technologically important ternary metal oxide nanostructures, which has hindered detailed experimental investigations on the size-dependent properties of these oxide materials. Developing approaches to prepare and scale up new synthetic formulations of these oxide nanostructures has been the recent focus of our efforts.

The environmentally acceptable protocols we have focused on in this group (SSW) include (i) molten salt synthesis (MSS) protocols, (ii) solvothermal/hydrothermal methods, and finally, (iii) template-directed techniques.

The green advantages of the MSS protocol are that it is simplistic, is readily scaleable, and uses relatively nontoxic reaction media and reagents (e.g., table salt). Applications of this method to the synthesis of  $\text{BaTiO}_3$  nanoparticles,  $\text{SrTiO}_3$  nanocubes,  $\text{Ca}_{1-x}\text{Sr}_x\text{TiO}_3$  nanoparticles,  $\text{BaZrO}_3$  nanoparticles,  $\text{Bi}_2\text{Fe}_4\text{O}_9$  submicron cubes, as well as hematite and iron/magnetite nanocomposites have been successfully developed.

The environmentally acceptable attributes of solvothermal / hydrothermal methods are that (a) they are relatively large scale and high yield in terms of the quantity of desired products generated without substantial amounts of harmful byproducts, (b) can frequently use water as the solvent medium, and (c) can be run at reasonably low temperatures using cost-efficient, experimentally facile protocols. It is fortunate that variations of this methodology have been successfully applied to the synthesis of  $\text{BaTiO}_3$  and  $\text{SrTiO}_3$  nanotubes as well as to titanate and titania 0-D, 1-D, and 3-D nanostructures.

Finally, what is fundamentally environmentally progressive about the modified template techniques we have developed is the fact these reactions can be run under ambient conditions in aqueous solution with reliable control over shape, dimensionality, and crystallinity. The potential is to generalize this protocol to the synthesis of not only isolated structures but also arrays of different classes of materials including ternary metal oxides. The validity of these techniques has been demonstrated in the synthesis of  $\text{BaWO}_4$  and  $\text{BaCrO}_4$  nanorods, of arrays of  $\text{BaWO}_4$  and  $\text{BaCrO}_4$  nanorods, and of fluoride nanowires.

Our group (SSW) has long-standing goals of creating well-defined nanoscale building blocks with tailorable properties. We have been interested in relatively simple synthesis methods whose ideal attributes include stability as well as control of size, shape, morphology, and chemical composition in the ultimate product. It is evident that the cost-effective techniques we have described herein are a step in the right direction towards developing processes that allow for minimal impact (i.e., relatively benign reagents; little waste generation) on the environment without sacrificing on sample quality and quantity.

A few key issues of ternary metal oxide nanostructure synthesis nevertheless remain to be addressed and would be highly beneficial for applications ranging from photovoltaics to energy storage. These issues revolve around the fundamental theme of being able to reproducibly generate nanostructures by design starting from first principles, which is a key component of atomically precise manufacturing (APM), i.e., the ability to create and generate precise internal structures with control over feature size and shape, as described in the Introduction.

For most of the applications associated with ternary oxides at the nanoscale to maximize their full potential, generating crystalline nanostructures, with controllable sizes, shapes, and morphologies, on a large scale, using environmentally friendly protocols, represents a very significant experimental challenge. In fact, reproducibly and simultaneously generating control over nanoparticle structure, surface chemistry, monodispersity, crystal

structure, and assembly remains an elusive goal that is completely intertwined with APM.

The nature of defects (such as the presence of vacancies, dopants, and interstitial sites as well as their associated effects on properties) in these systems is not well understood but will need to be addressed. In the context of APM, devices incorporating these materials ought to be reproducible and reliable in order to incorporate the beneficial properties of these systems at the nanoscale. As an example of the significance of this synthetic capability, the availability of nanosized  $\text{Ca}_{0.7}\text{Sr}_{0.3}\text{TiO}_3$  particles may enhance the material's existing usage as an efficient dielectric barrier for the plasma-induced, catalyst-free decomposition of  $\text{CO}_2$ .

The exact growth mechanisms involved with most of the synthetic methods used for creating ternary oxide nanostructures are often a matter of speculation. For instance, it is empirically known that factors such as temperature, ionic strength, solvent viscosity, as well as the presence of organic ligands play an important role in determining the morphology of the final products. However, the exact mechanism of how each individual variable precisely correlates with overall nanoparticle growth is

rarely known. Importantly, it is experimentally non-trivial to probe the growth of these structures kinetically. All of these factors need to be addressed if APM is to become a reality.

In addition, properties of nanoscale materials, such as their mechanical, transport, photoconductive, thermoelectric, electronic, optical, and catalytic properties, are theoretically expected to differ from those of the bulk. Little though has been published on property investigations of these nanomaterials due to the relative infancy of the field. Hence, it is very difficult to postulate any precise structure-property correlations at this point. This issue would be resolved by APM.

Potential health and environmental issues associated with these various synthetic protocols of the as-obtained nanomaterials will need to be addressed in a timely fashion. APM would allow for a better understanding of the hazards and risks of these materials.

We believe that future work in this field will continue to focus on generating improved fabrication and synthetic strategies aimed at resolving these issues. Technological advances will arise from interdisciplinary contributions from teams of chemists, physicists, materials scientists, and engineers, thereby opening up new areas of nanoscience research.

## Biological Molecular Motors for Nanodevices

### Introduction

One of the main aims of nanotechnology must be to incorporate moving parts into useful nanoscale devices. These moving parts may range from simple valves through to complex “conveyor belts” that will carry the building blocks for further construction from one place to another in an ordered and programmable manner – providing a version of the “molecular assembler,” which was first described by Eric Drexler (Drexler, 1999; Drexler, 1992).

It is possible that some of the molecular motors, which will be used for some of these moving parts, will be artificial chemical constructs, or chemical molecular motors (Figure 1). One of the problems posed by many chemical motors has been the development of a simple mechanism to drive the motor away from an equilibrium position, the motor shown in Figure 1 uses a chemical system to ensure stability of each state of the motor. However, other methods have been developed such as the recently described “information ratchet” in which light is used to propel a chemical molecular machine (Serreli *et al.*, 2007).

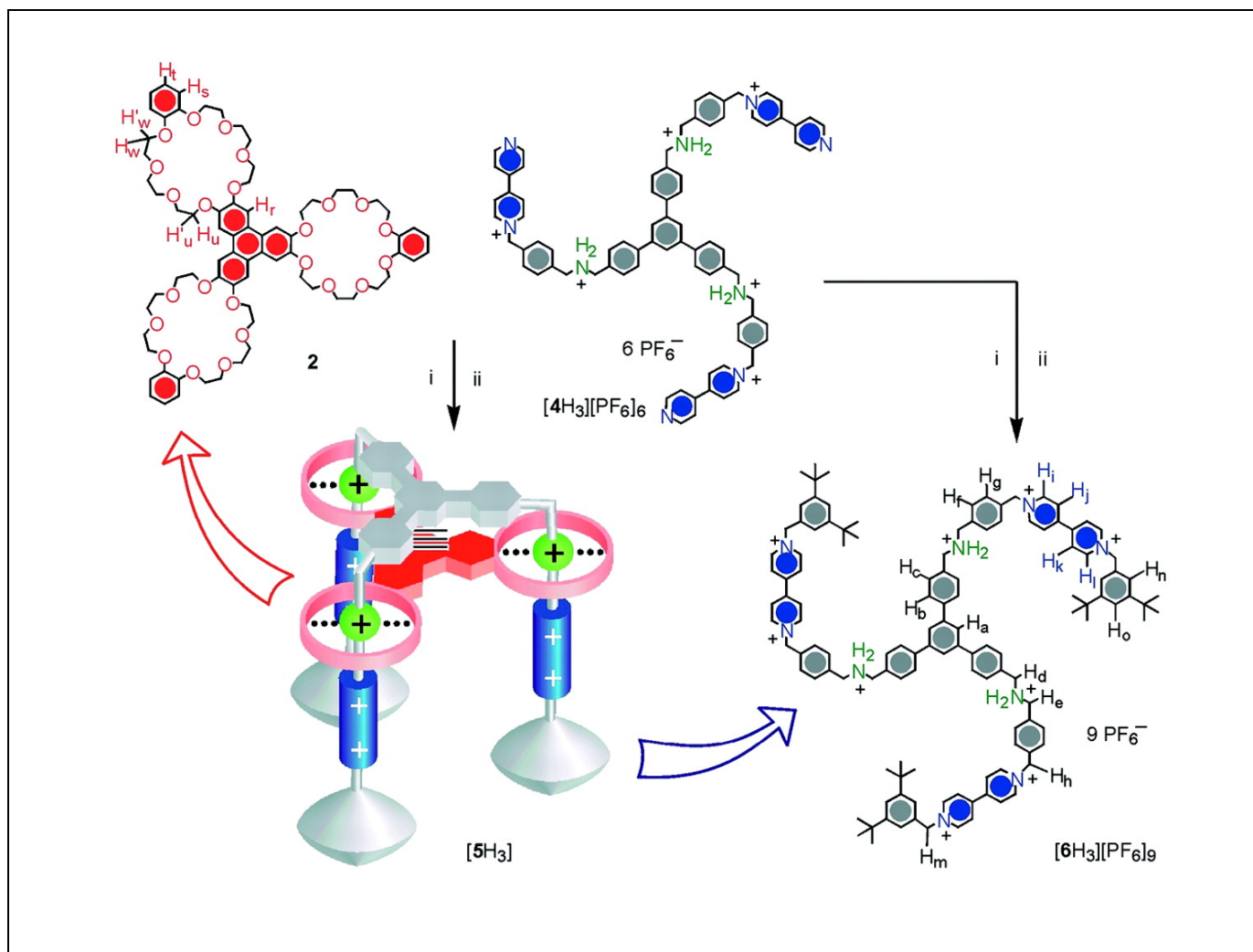

**Figure 1. A molecular elevator based around chemical motors.**

This chemical motor is only 3.5 nm by 2.5 nm and yet, through the integration of several chemical units is capable of generating a force of 200 pN per molecule. Importantly the motor has an inbuilt mechanism that prevents the reverse reaction allowing useful work to be performed at the expense of chemical energy. *Reproduced with permission from Badjic et al., 2004.*

An alternate version of a chemical motor, which depends upon one of the most important biological macromolecules, is a DNA-based biochemical motor. The first description of such a motor involved a simple chemically induced transition in the DNA structure (Figure 2) – a structural flip between B- and Z-form DNA – and this movement was detected by placing fluorophores on the ends of the DNA molecules and measuring FRET signals (Mao *et al.*, 1999). This was quickly followed by a DNA-fuelled motor that could act as a simple tweezer system (Yurke *et al.*, 2000) and used other DNA molecules as the fuel to enable motion. This motion was again detected through fluorescence output. This work has led to the idea of DNA molecules that could perform walks along a DNA “scaffold” with in-built directionality (Turberfield *et al.*, 2003, Yin *et al.*, 2004, Yin *et al.*, 2005a, Yin *et al.*, 2005b). This “DNA Walker” (Figure 3) would mimic the transport system of a cell (kinesin walking along microtubules) in a truly chemical system, possibly with cargo being detached from the moving DNA by means of the “molecular scissors” of biology – DNA restriction enzymes.

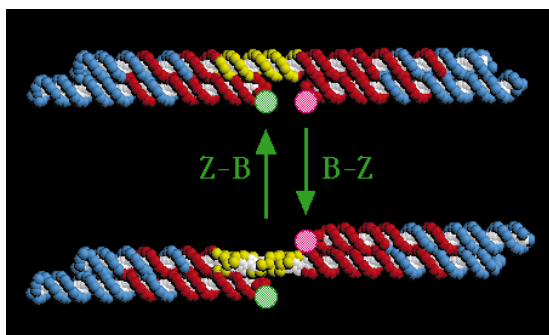

**Figure 2. A DNA motor based on B to Z transitions.**

This simple chemical motor depends upon the properties of DNA (Mao *et al.*, 1999), which is capable of adopting different conformations dependent upon the buffer composition (Zhang *et al.*, 2006), the motor action of the B-Z transition was monitored using FRET fluorescence from the two fluorophores at the end of each DNA molecule (pink and green circles). *Reproduced with permission from Prof. Nadrian Seeman.*

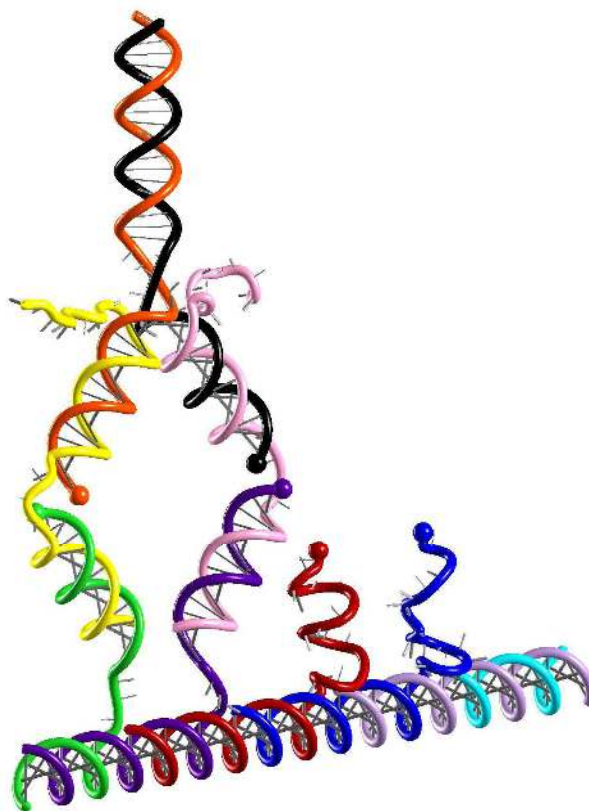

**Figure 3. A DNA “walker.”**

This machine is also entirely built from DNA, but in this case the movement is dependent upon hybridisation between complementary strands of DNA and forward, unidirectional motion is ensured through the use of ligation and cleavage reactions (Yin *et al.*, 2004). *Image reproduced with the permission of Prof Niles A. Pierce.*

## Biological Molecular Motors

However, biological molecular motors abound in natural systems and many of these motors are now readily available, having been isolated and purified, and have been studied extensively at both the biochemical level (Spudich, 1994) and the single-molecule level (Wang, 1999). These motors exist as both rotary motors (e.g. ATP synthase and the bacterial flagella motor) and linear tracking motors (e.g. kinesin), which provides an opportunity for use of the motors in a wide variety of different types of devices (Kinosita Jr., 1998). In addition, Nature’s machines are often optimised for efficiency (Kinosita *et al.*, 2000), which suggests that using what is already available may be much easier than *de novo* design and production of equivalent machines.



Perhaps the most complex biological machine is the ribosome, which acts as the “*protein factory*” of the cell, continually synthesising proteins with extremely high fidelity in a complex that is no larger than 30-50nm. This machine is seen by many as the model for future nano-devices in which a nanoscale machine can assemble atoms and molecules, in a highly programmable manner (i.e., a model system on which to design the “*molecular assembler*”), to produce novel combinations and, consequently, new materials (Drexler, 1999). Yet such a device remains, at this time, only a long term goal and is unlikely to function without the use of biological molecular motors to provide much of the movement required to transport the building blocks supplied by some programmable template and to position these building blocks for chemical synthesis of new materials (Hla & Rieder, 2003).

## Overview of Types of Biological Molecular Motors

Even the most simple organisms possess molecular motors:

- The bacteriophage (a virus that infects bacteria) possess a rotary motor (Figure 4) used to pack DNA into the bacteriophage head (Smith *et al.*, 2001). This motor works rather like a cork and corkscrew, where the DNA is the corkscrew (Simpson *et al.*, 2000). This simple but elegant molecular motor, consisting of a 10nm ring of proteins, compresses DNA into the phage head by reducing the volume, occupied by the DNA, by approximately 6,000 fold and the resulting internal pressure, within the phage head, is thought to be of the order of 60 atmospheres.
- Bacteria have rotary motors that drive the whip-like motion of their flagella (Figure 5), which, in turn, provides the bacteria with a ‘swimming’ movement (Ryu *et al.*, 2000). These motors provide one of the best examples of self-assembly in nature, comprising ~40 proteins (Suzuki *et al.*, 2004, Samatey *et al.*, 2004) that are synthesised within the cell and then transported, through the self-assembled structure of the motor, to the appropriate site for assembly of the flagellum on the outside of the cell. This type of self-assembly is frequently observed in biological systems and provides a blueprint for the requirements of nanodevices – they will have to be able to self-assemble at precise locations to provide the required “bottom-up” approach to nanotechnology (Zhang, 2003).
- Muscle (myosin) is a typical linear motor in that it enables sliding of actin fibres along myosin fibres; although the motion at the heart of the myosin motor is in part a rotary motion that is transmitted to the actin fibre as a linear motion through a long lever-arm. This lever-arm also amplifies the motion produced by the molecular motor from a few nanometres to 10nm (Yanagida *et al.*, 2000). Myosins are ubiquitous in the cell, with a wide range of functions ranging from control of balance in complex organisms such as man, through to cell division during mitosis.
- However, kinesins may represent the most useful type of linear motors as Nature already uses these for carrying objects around the cell (Jia *et al.*, 2004). These motors travel along microtubules (Figure 6), which radiate around the cell in three dimensions, transporting their cargoes to various parts of the cell. The cargoes can be proteins, vesicles or organelles many times the size of the motor (Sheetz, 1999, Steinberg, 2000, Kamal & Goldstein, 2002, Seog *et al.*, 2004).
- Dyneins also act as ATP-driven molecular motors that are able to generate a force relative to microtubules. They are identified in three classes, which are primarily determined by subcellular localisation - inner- and outer-flagella arm dyneins and cytoplasmic dyneins. This localisation matches the cellular activities, the first being the inner- and outer-flagella movements and the second is the movement of cellular organelles (c.f. kinesins - Harrison & King, 2000).
- Another important group of motors are those that utilise DNA as their linear track (rather like kinesin and dynein use microtubules). These include polymerases such as RNA polymerase (Harada *et al.*, 1999), DNA polymerases, helicases and topoisomerases. One key area of interest generated by these molecular motors is single molecule DNA sequencing (Meldrum, 2000).
- Finally, an unusual, but maybe an all important group of motors that move DNA are DNA translocases (Seidel *et al.*, 2004). Unlike the other motors mentioned above, these enzymes do not simply ‘run along the DNA track’, but rather bind the DNA and ‘pull’ the rest of the DNA through the bound complex (Figure 7). This provides for a very flexible system because the motors usually have a specific recognition sequence on the DNA (therefore, the position on the DNA can be readily defined) and they can produce useful work, because they create relative motion with respect to the surface on which the DNA is attached (they do not require the motor to be surfaced attached to obtain useful work, which is the case for polymerases).

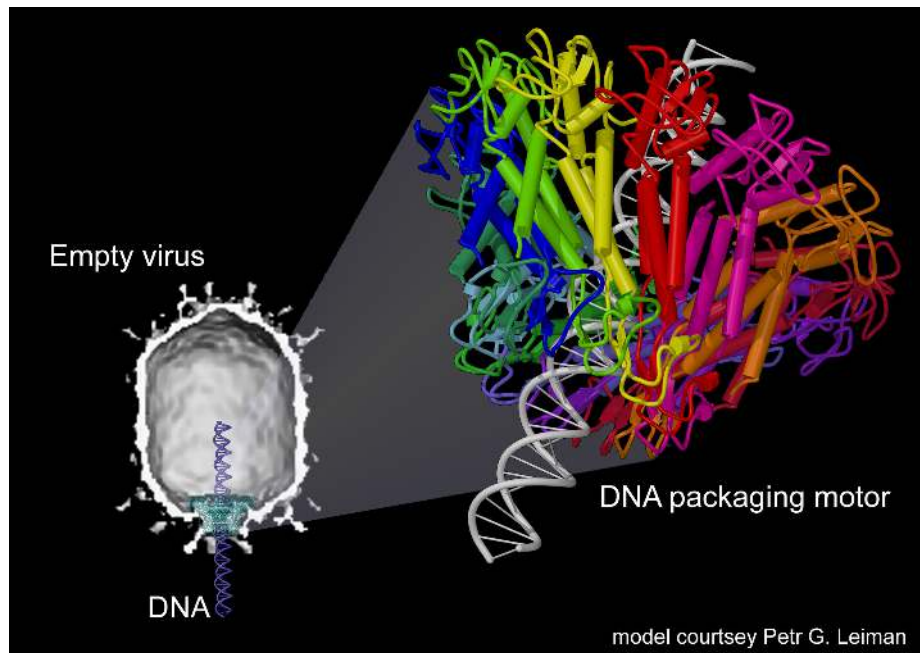

This multisubunit motor acts as the “cork” on a DNA “corkscrew” and literally winds the DNA into the bacteriophage head (Simpson et al., 2000).

Reproduced with kind permission of Prof Michael Rossmann, Purdue University.

**Figure 4. A DNA packaging motor from a bacteriophage.**

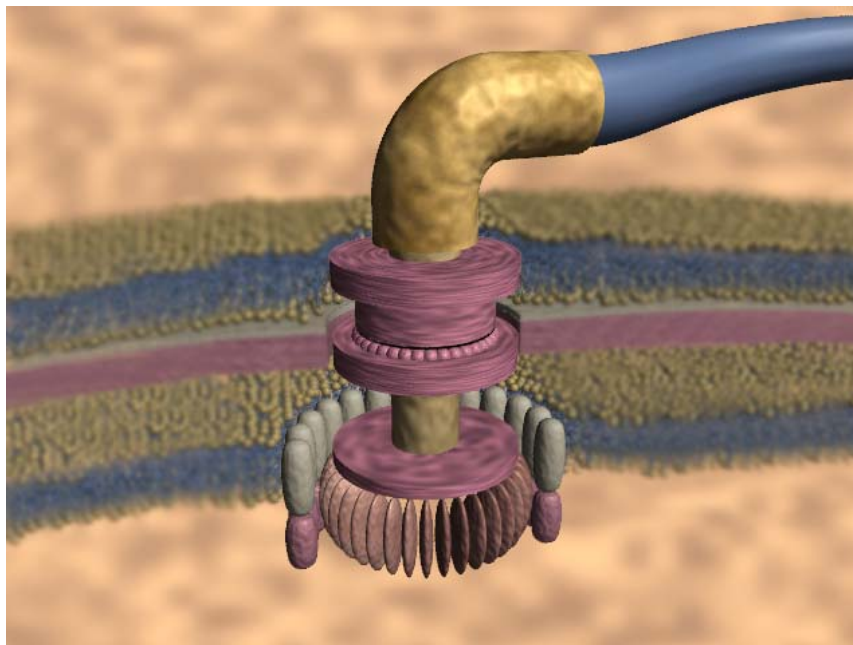

The bacterial flagellum consists of approximately 40 proteins. The proteins are produced within the cell and then self-assemble at the bacterial membrane to produce the molecular motor, which transverses the lipid bilayer of the bacterial envelope, and through which the flagellum proteins pass to assemble the external flagellum (Berg, 2003). The motor comprises many of the components associated with motors constructed on the macroscale – bearings, a drive shaft and a stator through which energy is transmitted to drive the motor. We acknowledge Access Research Network at <http://www.arn.org/docs/mm/motor.htm>, who hold the Copyright for this image, and who allow reproduction of the image for non-profit making use.

**Figure 5. The rotary motor of the bacterial flagellum.**

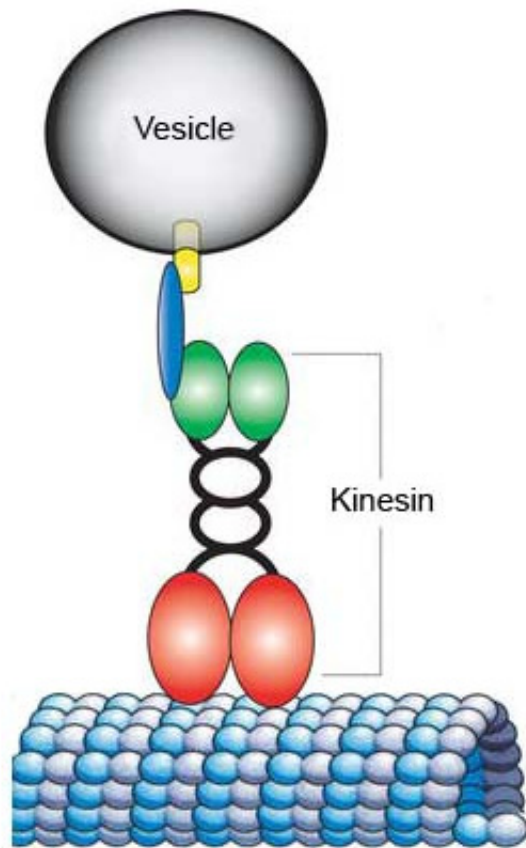

Kinesin motors can “walk” along the microtubule of the cell through an series of steps that involve hydrolysis of ATP (Hua *et al.*, 1997), the directionality of the walk appears to be inbuilt into the microtubule; although, different kinesin family members can move in different directions (Woehlke & Schliwa, 2000).

This image is based on an image in (Duncan & Goldstein, 2006).. This is an open-access article distributed under the terms of the Creative Commons Attribution License, which permits unrestricted use, distribution, and reproduction in any medium, provided the original author and source are credited.

**Figure 6. The kinesin molecular motor.**



**Figure 7. DNA translocation by a DNA translocase molecular motor.**

(a) The DNA-binding molecular motor binds to DNA, that is attached to a surface, at a specific DNA sequence unique to each motor. (b) The motor ‘pulls’ the DNA through the bound complex toward both the surface and the bound motor. (c) Pulling the DNA also pulls the DNA-bound magnetic bead toward the motor. (d) The motor stops at the bead and the motor subunit is released resetting the nanoactuator. (e) After resetting fresh motor protein will allow the nanoactuator to be reused (Seidel *et al.*, 2004, Firman, 1999).

Copyright The University of Portsmouth, Keith Firman and Bob Healey.



## State of the Art in the Use of Molecular Motors

Much of the work with molecular motors originated in laboratories involved in the study of cell biology and this work, as a consequence, has centred on myosin(s) and kinesin(s). In the last few years this work has also involved increasing amounts of single molecule analysis and measurement, stimulated by the availability of Scanning Probe Microscopy (SPM) and Atomic Force Microscopy (AFM) (Baibyrin *et al.*, 1999), and rapidly led to the development of tools for handling and measuring forces at the single molecule level – Optical Tweezers (Marx, 2001, Coirault *et al.*, 2003) and Magnetic Tweezers (Zlatanova & Leuba, 2003, Hosu *et al.*, 2003).

### Atomic Force Microscopy and Related Microscopy

The first atomic force microscope, produced in 1986 and was a direct descendant of the Scanning Tunnelling Microscope - STM (Binnig *et al.*, 1986). The need for such a microscope resulted from the desire to image insulating materials, particularly biological molecules and polymers where electron tunnelling effects are difficult to achieve. The microscope consists of a small stylus or tip which extends in a perpendicular direction from the free end of a silicon, or silicon nitride, cantilever. The radius of curvature of the tip lies between 10-100 nm. During operation, the cantilever unit remains stationary and the underlying sample is scanned back and forth. The cantilever acts as a soft spring of known spring constant, which obeys Hooke's Law,

$$F = -kz$$

Where  $F$  is the extending force acting on the cantilever,  $k$  the cantilever spring constant and  $z$  the vertical displacement of the cantilever. The deflection of the cantilever is monitored by a laser beam, which is reflected from the back of the cantilever surface onto photodiodes via a feedback circuit that ensures a constant force is applied to the sample surface. When operating in this way, the AFM is said to be in “contact” mode. The forces observed during scanning are of the order of 1 to 10 nN.

The majority of early AFM experiments were carried out in air but a great advantage of the technique is that images can be obtained whilst the sample is immersed in liquid. This is important because it not only allows the visualisation of dynamic biological events in real time in a natural environment but also because it greatly reduces the interactive forces between the tip and substrate. In liquids, capillary forces are very nearly eliminated. To minimise the forces during “contact mode” imaging which may damage, or move the sample, AFM measurements may also be

carried in “non-contact” or “tapping mode” (Camesano *et al.*, 2000, Pang *et al.*, 1997). This techniques, often termed Scanning Probe Microscopy (SPM), may be done in both air and liquid environments and has proven to be a highly successful technique for gaining additional structural details about the samples under investigation, particularly biological specimens (Figure 8).

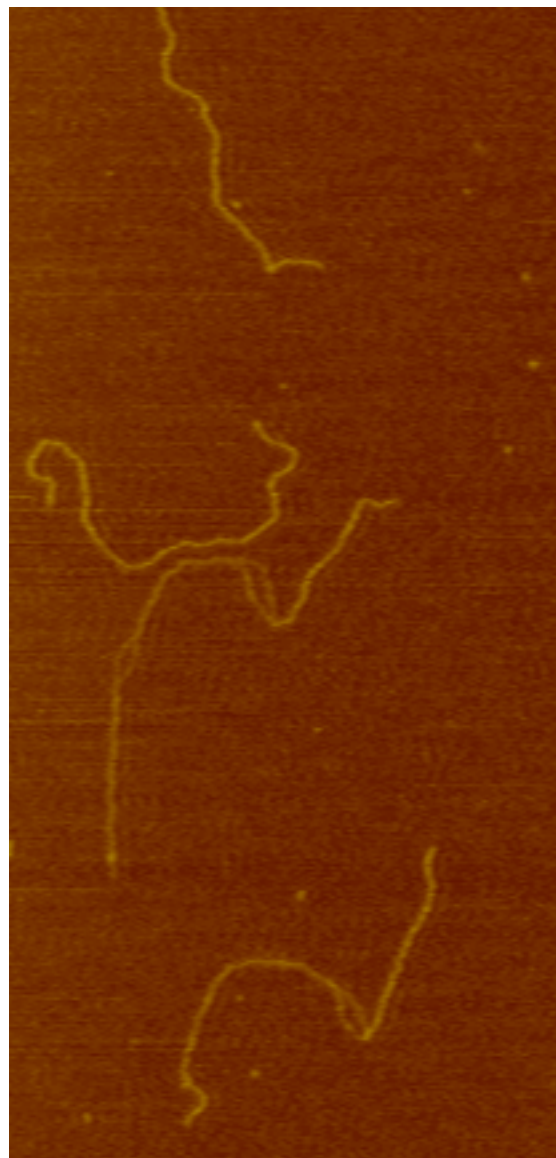

**Figure 8. An image of DNA with a bound Type I restriction-modification enzyme.**

DNA molecules were spread on a mica surface as described in (van Noort *et al.*, 2004). The image quality is such that local melting of the DNA can be easily observed. *This image is reproduced with kind permission of Cees Dekker and John van Noort.*

Tapping mode operates by oscillating the cantilever a known distance from the sample surface whilst the sample is being scanned in a lateral direction. When the tip-sample distance varies due to the surface features, the frequency of the cantilever oscillation is forced to change and the amplitude at a given frequency is lowered. Feedback systems then lower the position of the sample stage so that the cantilever resorts to its original amplitude of oscillation; thus, the topography of the sample is recorded. Care needs to be taken when interpreting SPM images to avoid artefacts that may result from tip shape or dimensions (e.g. double images will be obtained if there is a double tip - Beebe *et al.*, 1989). The tip is also susceptible to contamination and so image quality may reduce with scanning.

### Optical Tweezers

As the laser power in a focussed beam is increased, the distribution of molecules in solution no longer follows a

Poisson distribution (Chiu & Zare, 1996). The molecules no longer undergo random diffusion, but instead have a tendency to move to the point of maximum electromagnetic radiation (the focus of the laser beam – Figure 9). This movement is due to an interaction of an induced dipole moment on a molecule and the electromagnetic field that induces the dipole. The resultant interaction is attractive and has been termed an “*optical trap*.” Initially such optical traps were used to manipulate microscopic beads and micro-spheres, but at high enough laser power single molecules such as DNA can be moved (Nie & Zare, 1997, Wang, 1999). Feedback systems have been developed for optical traps allowing the direct measurement of molecular forces produced by molecular motors (Finer *et al.*, 1994). DNA-based uses of molecular tweezers, or optical traps, usually involve attachment of beads at the ends of the DNA. These beads are held apart in the trap and molecular forces such as DNA-looping are measured through the movement of the beads (Sakata-Sogawa *et al.*, 1998).

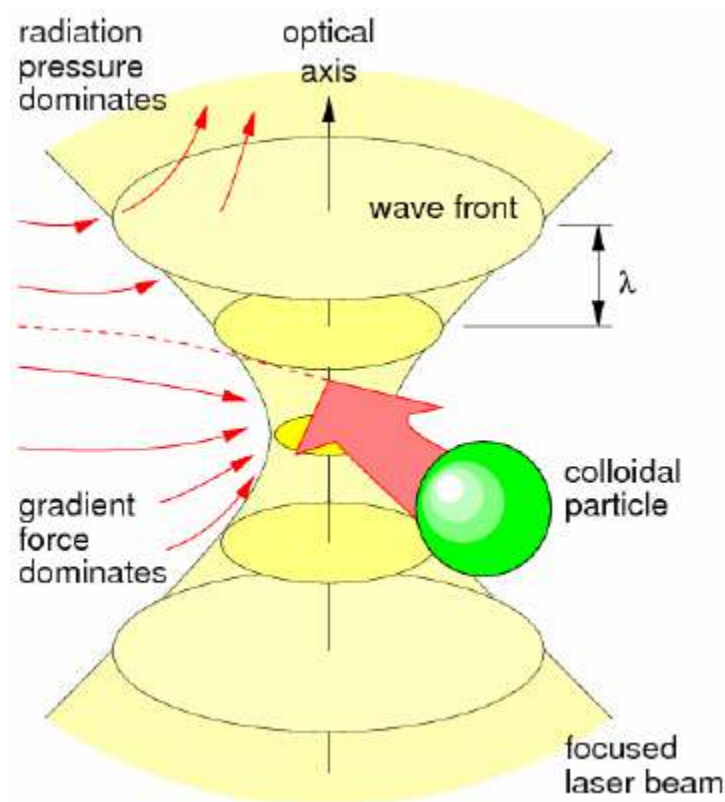

In an Optical Tweezer Setup a laser beam with a “Gaussian intensity profile” is used to trap a particle at the centre of the beam. The movement of this particle within the beam can be monitored through a feedback mechanism to determine forces and directional movement.

*Reprinted with permission from Macmillan Publishers Ltd: Nature (Grier, 2003), copyright (2003).*

**Figure 9.** An optical tweezer setup.



## Magnetic Tweezers

Magnetic tweezers are another form of a field gradient trap (Figure 10). The first magnetic tweezer setup was designed by (Crick & Hughes, 1950) where permanent magnets were used to apply forces to ferromagnetic beads attached to the surface of cells. The original apparatus has been modified in more recent experiments to utilise strong electromagnets in place of permanent magnets and superparamagnetic beads in place of ferromagnetic beads (Figure 10). However, the concepts remain the same; using the electromagnets to produce a strong field for the alignment of the superparamagnetic beads and high field gradients for the actual manipulation of the beads and any attached substrate. Magnetic tweezers can be used to apply forces of up to 10pN and allow force resolution down to

below 0.1pN, in addition to their ability to manipulate particles. Recent research using the magnetic tweezers setup has characterised the motor activity of polymerases (Maier *et al.*, 2000), translocases (Seidel *et al.*, 2004), topoisomerases (Dekker *et al.*, 2002) and also insight has been gained into chromatin assembly (Leuba *et al.*, 2003).

## Types of Biological Molecular Motors Available

Single molecule studies have allowed workers to determine the forces generated by a wide variety of molecular motors (Table 1) and has opened the way for possible applications of these motors in nanotechnology.

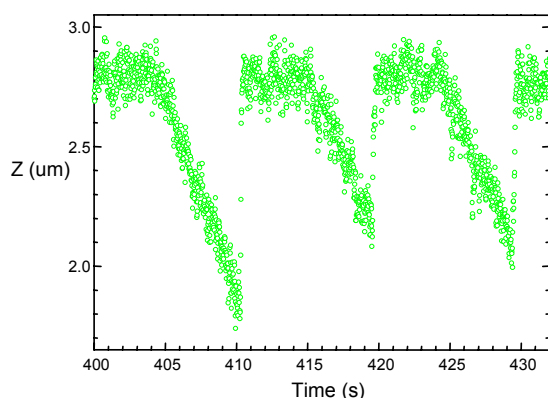

A magnetic tweezer setup consists of an inverted microscope with a flowcell mounted above the objective. DNA is attached to the surface of the flowcell (inset) and a DNA attached magnetic bead is used to stretch the DNA vertically. The height of the bead above the floor of the flowcell can be determined using the diffraction rings that surround the image of the bead. These can be plotted against time and used to determine speed of movement of the bead (green traces are images of the bead movement produced by EcoR124I). Magnetic tweezers can also be used to twist the DNA producing positive or negative supercoils in the DNA.

The illustration of the Magnetic Tweezer Setup was kindly provided by Prof David Bensimon and the translocation data was provided by kind permission of Cees Dekker and Ralf Seidel (Seidel *et al.*, 2004).

**Figure 10.** A magnetic tweezer setup.

**Table 1. Characteristics of a variety of molecular motors.**

Name of Motor	Type of Motion	Fuel	Forces Generated	Speed
Viral head motor of Phi29 bacteriophage	Rotary	ATP	57-60 pN	100 bp sec <sup>-1</sup> (0.03 μm sec <sup>-1</sup> )
Bacterial flagella	Rotary	Protons or Cations (1000 protons per rev.)	~25 pN	1700 Hz
ATP Synthase (Kinosita et al., 2004; Kinosita, 1999)	Rotary	Proton Flux	~30 pN-nm (torque)	130 Hz
Myosin(s)	Nominally linear	ATP	5-6 pN	N/A
Kinesin(s)	Linear	ATP	5-7 pN	100 steps sec <sup>-1</sup>
DNA and RNA polymerase	Linear	Chemical synthesis / hydrolysis of nucleotides	7 pN	550 bp sec <sup>-1</sup> (0.19 μm sec <sup>-1</sup> )
DNA translocases	Linear	ATP	8 pN	550 - 5500 bp sec <sup>-1</sup> (0.19 - 1.9 μm sec <sup>-1</sup> )

Biological molecular motors offer a number of opportunities for nanotechnology of which perhaps the most important is their ability for self-assembly. The bacterial flagella is an excellent example of the capabilities of biological systems for self assembly. It is composed of ~40 proteins, which are synthesised inside of the bacteria, are then transported to the membrane, where they assemble as the motor, and then the flagellum is built up by passage of the proteins through the centre of the motor and hook to self assemble on the outside of the bacteria.

A key aspect of bionanotechnology is to harness this ability to self-assemble, through precise attachment of suitable material, onto surfaces, which will enable the self-assembly to occur at precisely determined positions in defined ways. Perhaps one key technology that might enable patterning of surfaces in a reliable manner is the Dip Pen Nanolithography (DPN) device that takes the technology of nanolithography one step further by providing a simple to use interface that resembles a computer 'art' package (Ginger *et al.*, 2004). DPN is a direct-write scanning probe-based lithography in which an AFM tip is used to deliver chemical reagents directly to nanoscopic regions of a target substrate (Piner *et al.*, 1999, Hong & Mirkin, 2000, Hong *et al.*, 1999).

### ATP Synthase

Perhaps the ATP Synthase motor lends itself to the construction of nanodevices most readily. It is a rotary motor that exists in two parts (F<sub>0</sub>F<sub>1</sub>-ATPase), one is buried in the mitochondrial membrane (F<sub>0</sub> - Figure 11), while the other part is attached to the central spindle of the membrane motor and is spun *in vivo* by movement of the membrane motor (F<sub>1</sub>). The F<sub>0</sub> motor is driven by a proton flux across the

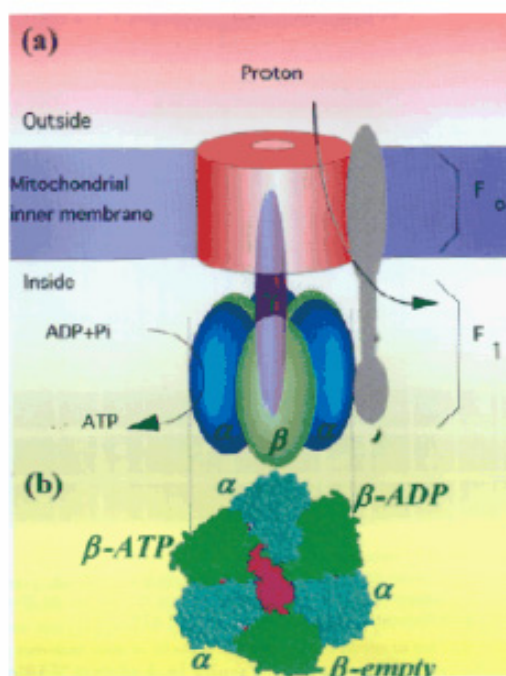
**Figure 11. ATP synthase.**

ATP Synthase consists of a membrane bound motor, driven by a flux of protons or sodium ions, which drives a separate motor that converts the mechanical energy into the synthesis of ATP (Stock *et al.*, 1999, Cross, 2000, Stock *et al.*, 2000). Reproduced with kind permission of Dr Alan E. Senior.

membrane and its movement leads to rotation of the  $F_1$  component. The lower motor then converts this mechanical energy into chemical energy that is used to synthesise ATP (which is the fuel of many other motors - Table 1). However, both motors are reversible and consumption of ATP can produce a proton pump that will pump protons out of the cell, across the membrane (Fillingame *et al.*, 2000, Stock *et al.*, 1999, Yasuda *et al.*, 2001, Sabbert *et al.*, 1996, Gao *et al.*, 2005)

The lower component of the motor has been purified and using modern affinity purification methods high yields have been obtained (Ishmukhametov *et al.*, 2005). The motor has also been genetically engineered in such a way that surface attachment is relatively simple (Adachi *et al.*, 2000), allowing useful work to be obtained from the motor, and furthermore attachment of a fluorophore to the motor allowed the motion to be directly visualised (Figure 12). In this elegant work moving images of the rotating fluorophore were captured, with the individual molecular motor behaving rather like a “lighthouse.” The rotating fluorophore can be readily seen in Figure 12 and a sinusoidal wave is apparent due to the rotation of the light source.

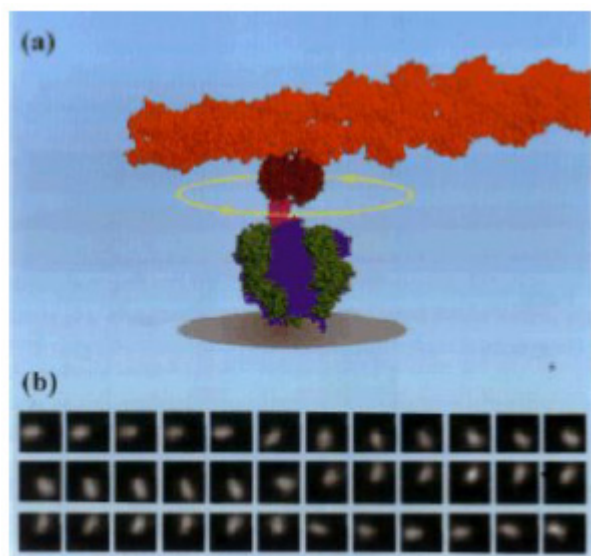

**Figure 12. ATP synthase rotating an actin fibre.**

An actin fibre, with attached fluorophore, is fixed to the ATP synthase molecular motor. Rotation of the fluorophore is shown in the still images captured in the figure (insets).

Reproduced from (Kinosita, 1999) with kind permission from Kazuhiko Kinosita.

Attachment of an actin fibre to this motor, labelled at one end with a fluorophore (Kinosita, 1999) quickly leads to the concept of using ATP Synthase as a nanodevice, which spins objects in such a way so as to “do useful work.” One such concept would be a rotating fibre driven by photons absorbed by the fluorophore (Yinghao *et al.*, 2005). However, it is not clear that the individual motor is capable of sufficient reliability and flexibility of motion for such tasks in any real device (Su *et al.*, 2006), or how to activate this motor in a truly useful manner – the requirement is one of efficient use of the photons captured.

Recently, a more efficient system for converting light into rotary motion has been described (Su *et al.*, 2006), which also allows self assembly of many rotary motors onto an actin fibre (Figure 13). The outcome of this arrangement was a swimming like motion of the actin fibre, which could ultimately be used as a means for propulsion of tiny nanomachines within a liquid environment. In effect the fibres attached to the motors are spinning like tiny propellers and this provides sufficient driving force to move the microscale actin fibre (~5 to 10 $\mu$ m long) over significant distances (up to ~70 $\mu$ m). Such microscale movement results from the cooperative action of these motors acting in parallel.

### *Kinesin and Microtubules*

As mentioned previously, kinesin is the cargo system of the eukaryotic cell, carrying many different sizes of cargo along microtubules within a cell (Klumpp & Lipowsky, 2005), but the complexity of the microtubule system suggests at first that using these motors in any nanodevice may prove difficult. However, a first step toward both handling these motors and making them carry out useful work was the observation that a surface coated with kinesin would transport microtubules (Vale *et al.*, 1985), but this motion is a random motion and it was not until surface etching was used (Hiratsuka *et al.*, 2001) that the motion of the microtubules could be organised (Figure 14).

Therefore, it is now possible to imagine custom designed surfaces that can be used for transporting material between different regions, but in this device using microtubules as the means for transporting the cargo. This simple arrangement has been greatly improved by the use of minute forces generated by “electrical steering” techniques, which has been used to demonstrate sorting of microtubules at Y junctions (van den Heuvel *et al.*, 2006) and the use of similar techniques to “dock” microtubules onto surfaces (van den Heuvel *et al.*, 2005), which could provide the mechanism for loading cargo onto the system.

The main problem now remaining for such a system, in a nanodevice, is how to efficiently release cargo from the transport system. Any such release system may depend upon site-specific proteases to cleave protein fusions.

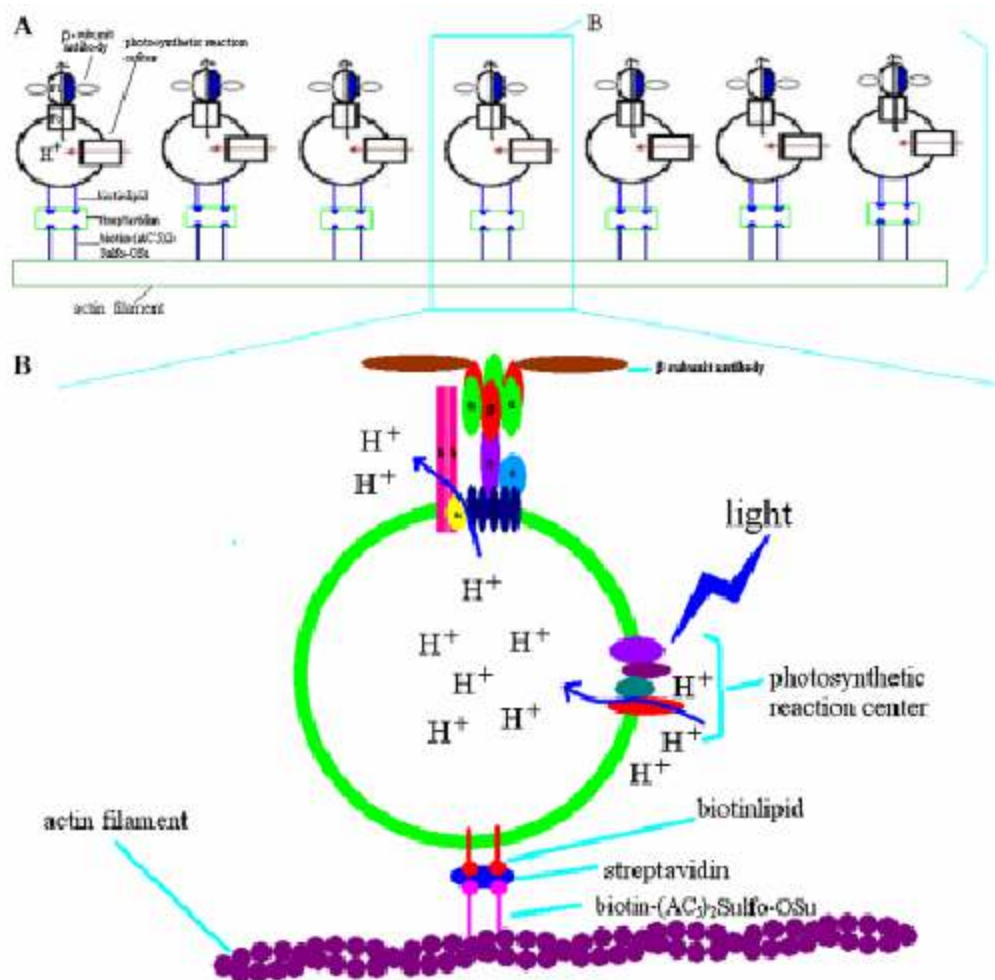
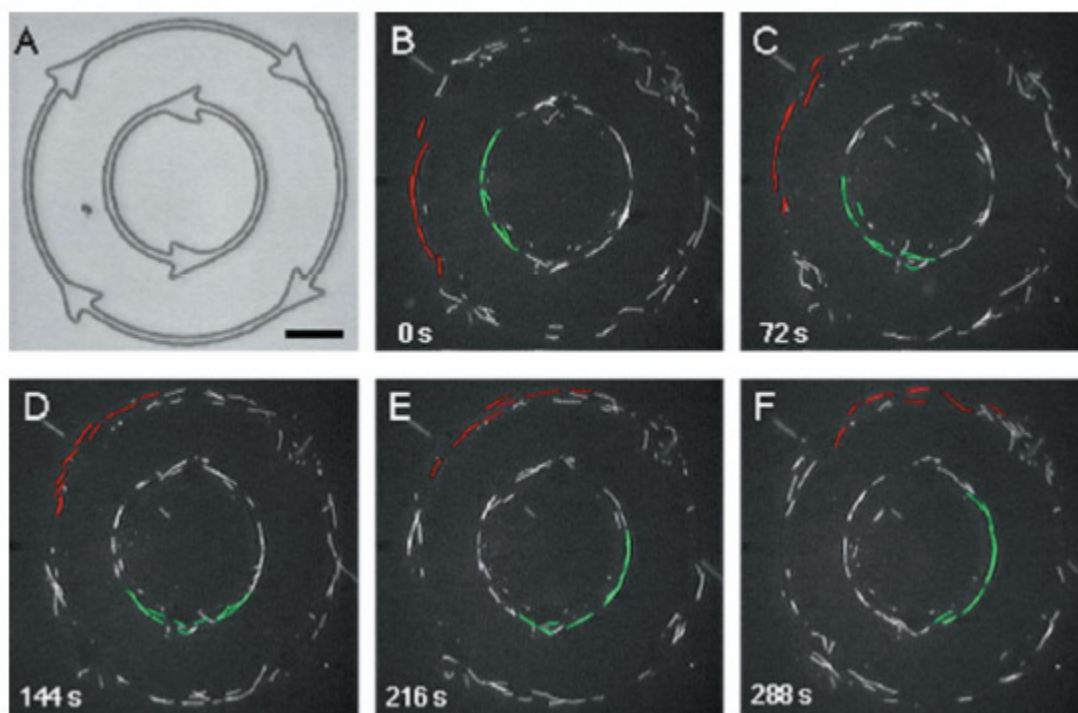

**Figure 13. A nanodevice driven by light, swimming through an aqueous environment.**

A nanodevice constructed from ATP synthase, which is able to use light to produce physical work in the form of a swimming motion produced through a propeller-like arrangement of the motor (Su et al., 2006).

Reproduced from (Su et al., 2006) with kind permission from Yue Jiachang.





**Figure 14. An etched surface used to control motion of microtubules.**

Directional control of the movement of microtubules, on a surface covered with kinesin, by means of an appropriately etched surface.

Reproduced with kind permission from Taro OP Uyeda, National Institute of Advanced Industrial Science and Technology, Tsukuba, Ibaraki 305-8562, Japan.

### *RNA and DNA Polymerases*

Polymerases that copy nucleic acids are also linear tracking motors. They obtain the energy for molecular motion from chemical synthesis – creation of the phosphodiester bond, a high energy covalent bond – and as a consequence they move along the DNA helix as they synthesise the new strand of DNA or RNA. One advantage of using motors that move DNA is that it is relatively easy to attach other molecules to the moving DNA. However, the problem with polymerases is that to obtain relative motion of the DNA (and the attached object), with respect to a surface, the motor itself must be surface attached (Figure 15).

The first single molecule studies of a polymerase involved RNA polymerase and these were used to determine the force and speed of these motors (see Table 1 and Wang *et al.*, 1998). As can be seen in Figure 15, the polymerase is surface attached and subsequently binds to the DNA, initiates RNA synthesis, which leads to the polymerase

‘pulling’ the DNA toward the surface and as a consequence pulls the bead out of the optical trap.

This work was extended to show, by direct observation, that the polymerase does in fact follow the helical thread of the DNA. The polystyrene bead, used in the previous experiment, was replaced with a magnetic bead, which was held vertically by an external magnetic field. In addition, the magnetic bead was visualised by attachment of small fluorescent nano-sized beads attached to the magnetic bead. Movement by the polymerase motor during transcription of the DNA produced rotation of the magnetic bead, which was visualised as a sinusoidal wave in the fluorescence output.

More recent work with RNA polymerases has shown that the positional resolution of force-paused complexes can be resolved to 5 bp (Shundrovsky *et al.*, 2004), and that the forward motion is that of a ‘Brownian ratchet’ (Guo & Sousa, 2006). This work has opened up the possibility of single-molecule DNA sequencing (Braslavsky *et al.*, 2003).



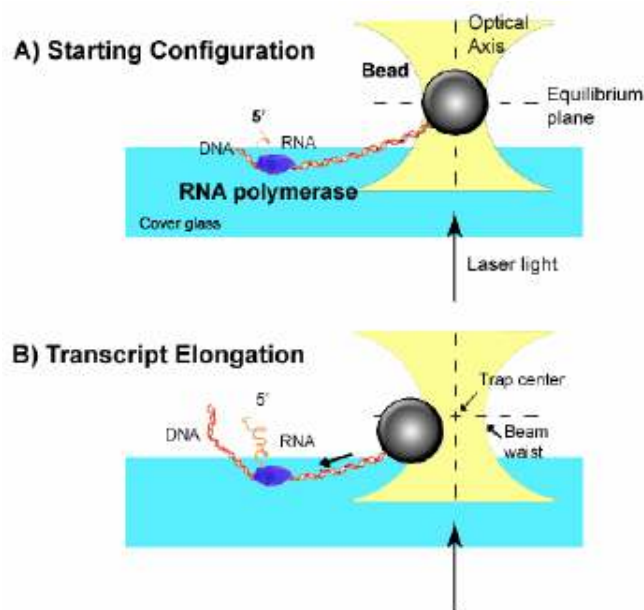

**Figure 15. Measuring motion of RNA polymerase.**

RNA polymerase was isolated on a coverslip and then the transcript elongation monitored using an optical tweezer setup. As the RNA polymerase transcribed the DNA template, Wang *et al.* (1998) were able to monitor the velocity and intensity of forces, using a feedback controlled instrument that could optically clamp the particle in place.

Copyright The University of Portsmouth, Keith Firman and James Youell.

## DNA Translocases

In an attempt to overcome the inherent problems associated with surface attachment of molecular motors and the problems associated with precise start-points for transcription or replication, which inhibit the potential uses of polymerase motors, we have initiated a single molecule study of DNA translocases.

There are only a limited number of such enzymes, of which the most studied are the Type I Restriction-Modification (R-M) enzymes ([www.typei-rm.info](http://www.typei-rm.info)), but others include chromatin remodelling factors (Flaus & Owen-Hughes, 2001), Type III R-M enzymes (Reich *et al.*, 2004), motors used in chromosome segregation (Saleh *et al.*, 2005a) and certain fusion proteins that link motor activity and specific DNA binding

We have studied the Type IC R-M enzyme EcoR124I in particular detail (Firman & Szczelkun, 2000), including single molecule analysis (Seidel *et al.*, 2004). In collaboration with other groups we have also closely studied the motor activity of FtsK (an enzyme involved in chromosome segregation in bacteria), including single-molecule studies (Saleh *et al.*, 2004). The single molecule studies have involved development of a Magnetic Tweezer Setup (Alenghat *et al.*, 2000 - Figure 10, Zlatanova & Leuba, 2003) to study forces generated by these motor, their speed and the dynamics of DNA binding (Seidel *et al.*, 2004, Seidel *et al.*, 2005, Saleh *et al.*, 2004, Saleh *et al.*, 2005b, Saleh *et al.*, 2005a). The Magnetic Tweezer Setup is a particularly useful tool for studying DNA-binding motors, which also illustrates the advantages of using a DNA translocase for manipulating DNA. The main advantage these motors offer is that DNA can be readily attached to the surface and the motor will bind at a known specific location on the DNA pulling the magnetic bead attached at the other end of the DNA toward the surface, producing a movement trace of the vertical position of the bead (Figure 10 inset).

The outcome of this type of motion is that the translocases are nanoactuators. They have a wide range of uses from simple valve-like devices through to motors for single-molecule DNA sequencing. However, perhaps their most important potential was demonstrated using EC-funding for the Mol Switch Project ([www.nanonet.org/molswitch/](http://www.nanonet.org/molswitch/)). In this Project we have shown that the moving magnetic bead can act as a “molecular dynamo,” generating electrons in a suitable sensor placed under the DNA (Figure 16). Such a device is a single-molecule reporting device, outputting an electrical signal from any biological input that generates fuel or releases motor. This is likely to find uses in biosensing and we are exploring its use in toxicity testing drug-DNA interactions. We have also demonstrated that the EcoR124I motor can be fused to a responsive polymer (Pennadam *et al.*, 2004a), which prevents motor activity – acting a switch – and may also provide protection to the motor in biosensing systems involving extreme conditions (Pennadam *et al.*, 2004b).

## Future Prospects—An Artificial Ribosome?

It was Eric K Drexler who first suggested the idea of a Molecular Assembler (an artificial ribosome capable of programmed assembly of materials other than amino acids - Drexler, 1992). He believes that the development of such a device is crucial to the future development of nanotechnology. Yet such a complex nanodevices still seems a distant dream.



**Figure 16. The mol switch device.**

The proposed device is a single-molecule reporting system for use in biosensing - the Mol Switch Device - consists of a microfluidics Lab-on-a-Chip device, which has Hall Effect (or magnetoresistive) sensors located within the main microfluidics channel. A single-molecule of DNA is attached above each sensor (through a digoxigenin-anti-DIG interaction following incorporation of DIG into one end of the DNA using PCR). The other end of the DNA molecule has an attached magnetic bead (through a biotin-avidin interaction following introduction of biotin into a PCR product). Introduction of an external magnetic field stretches the DNA molecules vertically prior to introduction of the molecular motor proteins. The presence of the molecular motor proteins, or any linked biological process generating motor or fuel, is signalled electronically by the individual sensors (single molecule signalling) each time the motor(s) pull a magnetic bead toward the sensor.

Copyright The University of Portsmouth, Keith Firman and Robert Healey.

The four components are required to produce such an artificial ribosome are:

1. A programmable system for ordered delivery of the building blocks of the material to be synthesised.
2. A mechanism for bringing these building blocks (in the correct order) to the site for assembly.
3. A means for carrying out highly localised single-molecule chemistry at the site of assembly.
4. A mechanism for release of the 'built' material and resetting of the machine.

DNA provides an ideal material for programming the order of delivery of the building blocks and a sensible approach would be to link the building blocks to short oligonucleotides (~12-mer), which could assemble along a stretch of single-stranded DNA in an order directed by the sequence of the DNA (which would be produced synthetically).

By making use of DNA translocases, a “conveyor belt” could easily be produced to “pull” the DNA and attached building blocks past an assembly site, which could be the tip of an STM (Hla & Rieder, 2003), so as to allow the synthetic chemistry that will join the building blocks together in the required order. DNA Translocases such as EcoR124I are particularly useful in this area as they will bind at one end of a long DNA molecule, at a known sequence, they can pull the DNA against an external force such a magnetic bead held by a weak magnetic force (which would stretch the DNA in one dimension, simulating a conveyor belt) and they can translocate past nicks and small gaps in the DNA (Stanley *et al.*, 2006), which may exist on the DNA as the oligos that were attached to the building blocks pass the translocase.

Release of the building blocks from the DNA can be carried out using nicking restriction enzymes such as N. BstSEI, which would cleave the oligonucleotide carrying the building block near the site of attachment of the building block to the DNA, releasing the newly synthesis material.

The system can be reusable because the short oligonucleotides, still attached to the DNA conveyor belt, which will enable translocation of the DNA, can be subsequently washed away using salt solution.

In theory such a device could synthesise any polymeric material for which building blocks are readily available and for which can be joined together by a relatively simple chemistry. However, before such devices can be constructed a great deal of improvement needs to be made in the reliable and reproducible positioning of biomolecules and the subsequent self-assembly of the components of the nanodevice to the required design.

## Synthetic Biology and Surface Engineering

Synthetic Biology is seen by some researchers as “the new nanotechnology,” but in reality this subject area is better imagined as the application of engineering approaches to biological systems. An illustration of the concept of Synthetic Biology is provided by the iGEM Project, which allows non-skilled people to construct novel genetic elements from “component parts” such as promoters, genes, transcription terminators etc. ([http://parts.mit.edu/wiki/index.php/Main\\_Page](http://parts.mit.edu/wiki/index.php/Main_Page)). However, the basic concept of this type of Synthetic Biology, that biological components can be

“mixed and matched” to produce a wide range of novel functional constructs is likely to be an over simplification and many combinations will not work together. One obvious problem is protein solubility – it has been observed that different protein fusions can demonstrate radically different solubility for the required protein. However, the concept is a guide for what types of information would be useful for the future and a list of such components that includes a description of known results including negative results (e.g. combinations that have produced insoluble or aggregated protein) would be a powerful resource for the future.

Another aspect of Synthetic Biology will be the careful positioning of biomaterial (Leach *et al.*, 2001), most probably through surface attachment, in microfluidics channels, which will become part of a Lab-on-a-Chip device (Daw & Finkelstein, 2006). Engineering of such nanoscale devices will make great demands on current metrology.

## Conclusions

With the advent of single molecule sensing, in the form of optical and magnetic tweezers setups and AFM and related microscopy, better characterisation of molecular motors has been achieved, allowing the first steps of nanodevice design to take place.

The incorporation of well characterised molecular motors into simple nanodevices has already begun (e.g. The Mol Switch Project - [www.nanonet.org/molswitch/](http://www.nanonet.org/molswitch/), The BioNano-Switch Project - <http://www.bionano-switch.info/> and Su *et al.*, 2006) and such devices have a broad range of applications, from toxin sensing to single molecule DNA sequencing.

As more molecular motors are characterised it seems that the goal of producing a “Molecular Assembler,” as suggested by Eric Drexler, could be achieved. It would seem probable that a production line required for such a device would incorporate several molecular motors with separate, but complementary roles, which would be defined by their function. In addition, some form of stable “conveyor belt” mechanism would be required, for the transport of component molecules, for which DNA would seem the most likely candidate because of its inbuilt ability to carry the required programming information. Surface engineering and chemistry will have to provide a stable environment for the biological components to work within and also be designed so that single molecules can be accurately coupled to surfaces, in order that a production line can be accurately placed. The main stumbling blocks in the development of such a system will be the design of fusion proteins and DNA constructs that will maintain the desired functions without affecting their behaviour in the novel environments of the system.

## Acknowledgements

This article was published as a Review Article in *Nanotechnology Perceptions* 3: 75-96. Dr Keith Firman would like to thank the publishers of this paper – Collegium Basilea, Basel, Switzerland – for permission to reproduce the article for the US Roadmap for Productive Nanosystems.

## References

- Adachi, K., R. Yasuda, H. Noji, H. Itoh, Y. Harada, M. Yoshida & K. J. Kinoshita, (2000) Stepping rotation of F1-ATPase visualized through angle-resolved single-fluorophore imaging. *Proceedings of the National Academy of Sciences of the United States of America* **97**: 7243-7247.
- Alenghat, F. J., B. Fabry, K. Y. Tsai, W. H. Goldmann & D. E. Ingber, (2000) Analysis of cell mechanics in single vinculin-deficient cells using a magnetic tweezer. *Biochem Biophys Res Commun* **277**: 93-99.
- Badjic, J. D., V. Balzani, A. Credi, S. Silvi & J. F. Stoddart, (2004) A Molecular Elevator. *Science* **303**: 1845-1849.
- Baibyrin, V. B., N. P. Konnov & U. P. Volkov, (1999) Versatile scanned probe microscope. Technical and biological applications. *Proceedings of SPIE - The International Society for Optical Engineering* **3726**: 140-150.
- Beebe, T. P., Jr., T. E. Wilson, D. F. Ogletree, J. E. Katz, R. Balhorn, M. B. Salmeron & W. J. Siekhaus, (1989) Direct observation of native DNA structures with the scanning tunneling microscope. *Science* **243**: 370-372.
- Berg, H. C., (2003) The Rotary Motor of Bacterial Flagella. *Annu Rev Biochem* **72**: 19-54.
- Binnig, G., C. F. Quate & C. Gerber, (1986) Atomic Force Microscope. *Physical Review Letters* **56**: 930.
- Braslavsky, I., B. Hebert, E. Kartalov & S. R. Quake, (2003) Sequence information can be obtained from single DNA molecules. *Proc Natl Acad Sci U S A* **100**: 3960-3964.
- Camesano, T. A., M. J. Natan & B. E. Logan, (2000) Observation of changes in bacterial cell morphology using tapping mode atomic force microscopy. *Langmuir* **16**: 4563-4572.
- Chiu, D. T. & R. N. Zare, (1996) Biased Diffusion, Optical Trapping, and Manipulation of Single Molecules in Solution. *Journal- American Chemical Society* **118**: 6512-6513.
- Coirault, C., J. C. Pourny, F. Lambert & Y. Lecarpentier, (2003) [Optical tweezers in biology and medicine]. *Med Sci (Paris)* **19**: 364-367.
- Crick, F. H. C. & A. F. W. Hughes, (1950) The physical properties of cytoplasm : A study by means of the magnetic particle method Part I. Experimental. *Exp Cell Res* **1**: 37-80.



- Cross, R. L., (2000) The rotary binding change mechanism of ATP synthases. *Biochim BiophysActa* **1458**: 270-275.
- Daw, R. & J. Finkelstein, (2006) Lab on a chip. **442**: 367.
- Dekker, N. H., V. V. Rybenkov, M. Duguet, N. J. Crisona, N. R. Cozzarelli, D. Bensimon & V. Croquette, (2002) The mechanism of type IA topoisomerases. *Proc Natl Acad Sci U S A* **99**: 12126-12131.
- Drexler, K. E., (1992) *Nanosystems: Molecular Machinery, manufacturing and Computation*. Wiley-Interscience.
- Drexler, K. E., (1999) Building molecular machine systems. *Trends in Biotechnology* **17**: 5-7.
- Duncan, J. E. & L. S. Goldstein, (2006) The genetics of axonal transport and axonal transport disorders. *PLoS genetics* **2**: e124.
- Fillingame, R. H., W. Jiang & O. Y. Dmitriev, (2000) Coupling H(+) transport to rotary catalysis in F-type ATP synthases: structure and organization of the transmembrane rotary motor. *J Exp Biol* **203 Pt 1**: 9-17.
- Finer, J. T., R. M. Simmons & J. A. Spudich, (1994) Single myosin molecule mechanics: piconewton forces and nanometre steps. *Nature*: 113.
- Firman, K., (1999) A polynucleotide motor. In: United Kingdom: University of Portsmouth, pp.
- Firman, K. & M. Szczelkun, (2000) Measuring motion on DNA by the type I restriction endonuclease *EcoR124I* using triplex dissociation. *EMBO J*. **19**: 2094-2102.
- Flaus, A. & T. Owen-Hughes, (2001) Mechanisms for ATP-dependent chromatin remodelling. *Current Opinion in Genetics and Development* **11**: 148-154.
- Gao, Y. Q., W. Yang & M. Karplus, (2005) A structure-based model for the synthesis and hydrolysis of ATP by F1-ATPase. *Cell* **123**: 195-205.
- Ginger, D. S., H. Zhang & C. A. Mirkin, (2004) The Evolution of Dip-Pen Nanolithography. *Angewandte Chemie* **43**: 30 - 45.
- Grier, D. G., (2003) A revolution in optical manipulation. *Nature* **424**: 810-816.
- Guo, Q. & R. Sousa, (2006) Translocation by T7 RNA Polymerase: A Sensitive Poised Brownian Ratchet. *J. Mol. Biol.* **358**: 241-254.
- Harada, Y., T. Funatsu, K. Murakami, Y. Nonayama, A. Ishihama & T. Yanagida, (1999) Single-molecule imaging of RNA polymerase-DNA interactions in real time. *Biophys J* **76**: 709-715.
- Harrison, A. & S. M. King, (2000) The molecular anatomy of dynein. In: Essays in biochemistry: Molecular motors. G. Banting & S. J. Higgins (eds). London: Portland Press, pp. 75-87.
- Hiratsuka, Y., T. Tada, K. Oiwa, T. Kanayama & T. Q. P. Uyeda, (2001) Controlling the Direction of Kinesin-Driven Microtubule Movements along Microlithographic Tracks. *Biophys J* **81**: 1555-1561.
- Hla, S. W. & K. H. Rieder, (2003) STM control of chemical reaction: single-molecule synthesis. *Annual review of physical chemistry* **54**: 307-330.
- Hong, S. & C. A. Mirkin, (2000) A nanoplotter with both parallel and serial writing capabilities. *Science* **288**: 1808-1811.
- Hong, S., J. Zhu & C. A. Mirkin, (1999) Multiple ink nanolithography: toward a multiple-Pen nanoplotter. *Science* **286**: 523-525.
- Hosu, B. G., K. Jakab, P. Banki, F. I. Toth & G. Forgacs, (2003) Magnetic tweezers for intracellular applications. *Review of Scientific Instruments* **74**: 4158-4163.
- Hua, W., E. C. Young, M. L. Fleming & J. Gelles, (1997) Coupling of kinesin steps to ATP hydrolysis. *Nature* **388**: 390-393.
- Ishmukhametov, R. R., M. A. Galkin & S. B. Vik, (2005) Ultrafast purification and reconstitution of His-tagged cysteine-less *Escherichia coli* F1Fo ATP synthase. *Biochimica et Biophysica Acta (BBA) - Bioenergetics* **1706**: 110-116.
- Jia, L., S. G. Moorjani, T. N. Jackson & W. O. Hancock, (2004) Microscale Transport and Sorting by Kinesin Molecular Motors. *Biomedical Microdevices* **6**: 67-74.
- Kamal, A. & L. S. Goldstein, (2002) Principles of cargo attachment to cytoplasmic motor proteins. *Curr Opin Cell Biol* **14**: 63-68.
- Kinosita Jr., K., (1998) Linear and rotary molecular motors. In: Mechanisms of work production and work absorption in muscle. H. Sugi & G. H. Pollack (eds). New York and London: Plenum Press, pp. 5-14.
- Kinosita, K., K. Adachi & H. Itoh, (2004) ROTATION OF F1-ATPASE: How an ATP-Driven Molecular Machine May Work. *Annu Rev Biophys Biomol Struct* **33**: 245-268.
- Kinosita, K. J., (1999) Real time imaging of rotating molecular machines. *FASEB J* **13 Suppl 2**: S201-208.
- Kinosita, K. J., R. Yasuda, H. Noji & K. Adachi, (2000) A rotary molecular motor that can work at near 100% efficiency. *Philos Trans R Soc Lond B Biol Sci* **355**: 473-489.
- Klumpp, S. & R. Lipowsky, (2005) Cooperative cargo transport by several molecular motors. *Proc Natl Acad Sci U S A* **102**: 17284-17289.
- Leach, R., J. Haycocks, K. Jackson, A. Lewis, S. Oldfield & A. Yacoot, (2001) Advances in traceable nanometrology at

- the National Physical Laboratory. *Nanotechnology* **12**: R1-R6.
- Leuba, S. H., M. A. Karymov, M. Tomschik, R. Ramjit, P. Smith & J. Zlatanova, (2003) Assembly of single chromatin fibers depends on the tension in the DNA molecule: Magnetic tweezers study. *Proceedings- National Academy of Sciences USA* **100**: 495-500.
- Maier, B., D. Bensimon & V. Croquette, (2000) Replication by a single DNA polymerase of a stretched single-stranded DNA. *Proc Natl Acad Sci U S A* **97**: 12002-12007.
- Mao, C., W. Sun, Z. Shen & N. C. Seeman, (1999) A nanomechanical device based on the B-Z transition of DNA. *Nature* **397**: 144-146.
- Marx, B., (2001) Optical tweezers help study molecular motors. *Laser Focus World* **37**: 30-33.
- Meldrum, D., (2000) Automation for genomics, part two: sequencers, microarrays, and future trends. *Genome Res* **10**: 1288-1303.
- Nie, S. & R. N. Zare, (1997) Optical detection of single molecules. *Annu Rev Biophys Biomol Struct* **26**: 567-596.
- Pang, D., B. Vidic, J. Rodgers, B. L. Berman & A. Dritschilo, (1997) Atomic force microscope imaging of DNA and DNA repair proteins: Applications in radiobiological research. *Radiation Oncology Investigations* **5**: 163-169.
- Pennadam, S., M. D. Lavigne, C. F. Dutta, K. Firman, D. Mernagh, D. C. Górecki & A. Cameron, (2004a) Control of A Multi-Subunit DNA Motor By A Thermo Responsive Polymer Switch. *Journal of the American Chemical Society* **126**: 13208-13209.
- Pennadam, S. S., K. Firman, C. Alexander & D. C. Górecki, (2004b) Protein-polymer nano machines. Towards synthetic control of biological processes. *Journal of Nanobiotechnology* **2**: 1-7.
- Piner, R. D., J. Zhu, F. Xu, S. Hong & C. A. Mirkin, (1999) "Dip-Pen" nanolithography. *Science* **283**: 661-663.
- Reich, S., I. Gossel, M. Reuter, J. P. Rabe & D. H. Kruger, (2004) Scanning Force Microscopy of DNA Translocation by the Type III Restriction Enzyme EcoP15I. *J. Mol. Biol.* **341**: 337- 343.
- Ryu, W. S., R. M. Berry & H. C. Berg, (2000) Torque-generating units of the flagellar motor of Escherichia coli have a high duty ratio. *Nature* **403**: 444-447.
- Sabbert, D., S. Engelbrecht & W. Junge, (1996) Intersubunit rotation in active F-ATPase. *Nature* **381**: 623-625.
- Sakata-Sogawa, K., M. Kurachi, K. Sogawa, Y. Fujii-Kuriyama & H. Tashiro, (1998) Direct measurement of DNA molecular length in solution using optical tweezers: detection of looping due to binding protein interactions. *Eur Biophys J* **27**: 55-61.
- Saleh, O. A., J. F. Allemand, V. Croquette & D. Bensimon, (2005a) Single-molecule manipulation measurements of DNA transport proteins. *Chemphyschem* **6**: 813-818.
- Saleh, O. A., S. Bigot, F. X. Barre & J. F. Allemand, (2005b) Analysis of DNA supercoil induction by FtsK indicates translocation without groove-tracking. *Nat Struct Mol Biol* **12**: 436-440.
- Saleh, O. A., C. Perals, F. X. Barre & J. F. Allemand, (2004) Fast, DNA-sequence independent translocation by FtsK in a single-molecule experiment. *EMBO J.* **23**: 2430-2439.
- Samatey, F. A., H. Matsunami, K. Imada, S. Nagashima, T. R. Shaikh, D. R. Thomas, J. Z. Chen, D. J. DeRosier, A. Kitao & K. Namba, (2004) Structure of the bacterial flagellar hook and implication for the molecular universal joint mechanism. *Nature* **431**: 1062-1068.
- Seidel, R., J. G. P. Bloom, J. van Noort, C. F. Dutta, N. H. Dekker, K. Firman, M. D. Szczelkun & C. Dekker, (2005) Dynamics of initiation, termination and reinitiation of DNA translocation by the motor protein EcoR124I. *EMBO J.* **24**: 4188-4197.
- Seidel, R., J. van Noort, C. van der Scheer, J. G. P. Bloom, N. H. Dekker, C. F. Dutta, A. Blundell, T. Robinson, K. Firman & C. Dekker, (2004) Real-Time Observation of DNA Translocation by the Type I Restriction-Modification Enzyme EcoR124I. *Nature Struct Molec Biol* **11**: 838 - 843.
- Seog, D. H., D. H. Lee & S. K. Lee, (2004) Molecular motor proteins of the kinesin superfamily proteins (KIFs): structure, cargo and disease. *J Korean Med Sci* **19**: 1-7.
- Serrelli, V., C.-F. Lee, E. R. Kay & D. A. Leigh, (2007) A molecular information ratchet. *Nature* **445**: 523-527.
- Sheetz, M. P., (1999) Motor and cargo interactions. *Eur J Biochem* **262**: 19-25.
- Shundrovsky, A., T. J. Santangelo, J. W. Roberts & M. D. Wang, (2004) A single-molecule technique to study sequence-dependent transcription pausing. *Biophys J* **87**: 3945-3953.
- Simpson, A. A., Y. Tao, P. G. Leiman, M. O. Badasso, Y. He, P. J. Jardine, N. H. Olson, M. C. Morais, S. Grimes, D. L. Anderson, T. S. Baker & M. G. Rossmann, (2000) Structure of the bacteriophage phi29 DNA packaging motor. *Nature* **408**: 745 - 750.
- Smith, D. E., S. J. Tans, S. B. Smith, S. Grimes, D. L. Anderson & C. Bustamante, (2001) The bacteriophage phis29 portal motor can package DNA against a large internal force. *Nature* **413**: 748 - 752.
- Spudich, J. A., (1994) How molecular motors work. *Nature* **372**: 515-518.



- Stanley, L. K., R. Seidel, C. van der Scheer, N. H. Dekker, M. D. Szczelkun & C. Dekker, (2006) When a helicase is not a helicase: ds DNA tracking by the motor protein EcoR124I. *EMBO J.* **25**: 2230-2239.
- Steinberg, G., (2000) The cellular roles of molecular motors in fungi. *Trends Microbiol* **8**: 162-168.
- Stock, D., C. Gibbons, I. Arechaga, A. G. W. Leslie & J. E. Walker, (2000) The rotary mechanism of ATP synthase. *Curr Opin Struct Biol* **10**: 672-679.
- Stock, D., A. G. W. Leslie & J. E. Walker, (1999) Molecular architecture of the rotary motor in ATP synthase. *Science* **286**: 1700-1705.
- Su, T., Y. Cui, X. Zhang, X. Liu, J. Yue, N. Liu & P. Jiang, (2006) Constructing a novel Nanodevice powered by [delta]-free FoF1-ATPase. *Biochem Biophys Res Commun* **350**: 1013-1018.
- Suzuki, H., K. Yonekura & K. Namba, (2004) Structure of the rotor of the bacterial flagellar motor revealed by electron cryomicroscopy and single-particle image analysis. *J Mol Biol* **337**: 105-113.
- Turberfield, A. J., J. C. Mitchell, B. Yurke, A. P. Mills, Jr., M. I. Blakey & F. C. Simmel, (2003) DNA fuel for free-running nanomachines. *Phys Rev Lett* **90**: 118102.
- Vale, R. D., T. S. Reese & M. P. Sheetz, (1985) Identification of a novel force-generating protein, kinesin, involved in microtubule-based motility. *Cell* **42**: 39-50.
- van den Heuvel, M. G., C. T. Butcher, S. G. Lemay, S. Diez & C. Dekker, (2005) Electrical docking of microtubules for kinesin-driven motility in nanostructures. *Nano Lett* **5**: 235-241.
- van den Heuvel, M. G. L., M. P. de Graaff & C. Dekker, (2006) Molecular Sorting by Electrical Steering of Microtubules in Kinesin-Coated Channels 10.1126/science.1124258. *Science* **312**: 910-914.
- van Noort, J., T. van der Heijden, C. F. Dutta, K. Firman & C. Dekker, (2004) Initiation of Translocation by Type I Restriction-Modification Enzymes is Associated with a Short DNA Extrusion. *Nucleic Acids Res.* **32**: 6540-6547.
- Wang, M. D., (1999) Manipulation of single molecules in biology. *Curr. Opin. Biotechnol.* **10**: 81- 86.
- Wang, M. D., M. J. Schnitzer, H. Yin, R. Landick, J. Gelles & S. M. Block, (1998) Force and velocity measured for single molecules of RNA polymerase. *Science* **282**: 902-907.
- Woehlke, G. & M. Schliwa, (2000) Directional motility of kinesin motor proteins. *Biochim Biophys Acta* **1496**: 117-127.
- Yanagida, T., S. Esaki, A. H. Iwane, Y. Inoue, A. Ishijima, K. Kitamura, H. Tanaka & M. Tokunaga, (2000) Single-motor mechanics and models of the myosin motor. *Philos Trans R Soc Lond B Biol Sci* **355**: 441-447.
- Yasuda, R., H. Noji, M. Yoshida, K. Kinoshita & H. Itoh, (2001) Resolution of distinct rotational substeps by submillisecond kinetic analysis of F1-ATPase. *Nature* **410**: 898 - 904.
- Yin, P., A. J. Turberfield & J. H. Reif, (2005a) Designs of Autonomous Unidirectional Walking DNA Devices. *Lecture Notes in Computer Science*: 410-425.
- Yin, P., A. J. Turberfield, S. Sahu & J. H. Reif, (2005b) Design of an Autonomous DNA Nanomechanical Device Capable of Universal Computation and Universal Translational Motion. *Lecture Notes in Computer Science*: 426-444.
- Yin, P., H. Yan, X. G. Daniell, A. J. Turberfield & J. H. Reif, (2004) A unidirectional DNA walker that moves autonomously along a track. *Angew Chem Int Ed Engl* **43**: 4906-4911.
- Yinghao, Z., W. Jun, C. Yuanbo, Y. Jiachang & F. Xiaohong, (2005) Rotary torque produced by proton motive force in FoF1 motor. *Biochem Biophys Res Commun* **331**: 370-374.
- Yurke, B., A. J. Turberfield, A. P. Mills, F. C. Simmel & J. L. Neumann, (2000) A DNA-fuelled molecular machine made of DNA. *Nature* **406**: 605-608.
- Zhang, H., H. Yu, J. Ren & X. Qu, (2006) Reversible B/Z-DNA transition under the low salt condition and non-B-form polyd(A)polydT selectivity by a cubane-like europium-L-aspartic acid complex. *Biophys J* **90**: 3203-3207.
- Zhang, S., (2003) Fabrication of novel biomaterials through molecular self-assembly. *Nat. Biotechnol.* **21**: 1171-1178.
- Zlatanova, J. & S. H. Leuba, (2003) Magnetic tweezers: a sensitive tool to study DNA and chromatin at the single-molecule level. *Biochem Cell Biol* **81**: 151-159.

## Molecular Motors, Actuators, and Mechanical Devices

### Introduction

Atomically precise manufacturing systems, such as those described in *Nanosystems* [Ref. 1], will utilize molecular motors and actuators<sup>1</sup> that drive components to perform useful work. The conversion of electrical and chemical energy into mechanical motion is facilitated by the use of gears, bearings, drive shafts, springs, and so forth, to direct the motion of components and minimize energy losses. Thus, research efforts dedicated to produce these sorts of components are considered to be both a direct pathway in our Roadmap and an enabler of other pathways that can take advantage of these molecular mechanical devices and the fabrication techniques developed to produce them. This section summarizes the state of the art in the construction of these devices and describes their relevance to the Roadmap. See the table at the end of the narrative provides a summary of representative molecular motors, actuators, and mechanical devices.

### Electric Nanomotors and Nanoactuators

In 2003, the Zettl Group at Lawrence Berkeley Laboratories and University of California at Berkeley fabricated the smallest known non-biological nanomotor [Ref. 3]. The device employed a multi-walled carbon nanotube (MWNT), which served as both a bearing for the rotor and as an electrical conductor, and had the following characteristics:

- Doped silicon substrate covered with  $1\mu\text{m}$   $\text{SiO}_2$
- Rotor, anchor pads, and electrodes—constructed lithographically; 90 nm gold layer with 10 nm Cr adhesion layer
- Rotor length 100 to 300 nm
- Bearing—MWNT's, 10 to 40 nm diameter,  $2\mu\text{m}$  length between anchor pads
- Torsional spring constant of the outer nanotube,  $10^{-15}$  to  $10^{-12}$  N-m “as produced;” however an electrical jolt ( $\sim 80\text{v}$  d.c.) caused the bonds to break, torquing the rotor and allowing the tube to rotate freely

<sup>1</sup> As Kay, Leigh, and Zerbetto point out in their excellent review article [Ref. 2], molecular machines are a subset of molecular devices that provide mechanical movement toward a useful end. While molecular switches are molecular machines that perform useful work by changing state (in molecular computational systems, for instance) they are not treated in this section.

- Speed—operated at several Hz, but potentially could run at gigahertz frequencies
- Vacuum— $10^{-6}$  to  $10^{-5}$  torr

This breakthrough is highly relevant because motors based on this concept could be used to drive systems of molecular mechanical components. If the outer nanotube were fractured at the far ends rather than right next to the rotor, then this motor-driven outer shaft could be connected (e.g., by molecular gears) to other components. It gains in significance because the operation of the motor is controlled with electrical circuitry, offering precise control from the desktop. Most importantly, the device is *individually addressable* from the desktop as opposed to broadcast architectures where light or chemical signals trigger operations on a large array of devices.

Furthermore, this research was significant because of the new technologies that were developed in order to fabricate this device, namely:

- A method for peeling off successive layers of nanotubes [Ref. 4]
- Precision cutting of, and selective damage to, nanotubes [Ref. 5]
- A manipulator capable of pulling out the inner nanotube in a MWNT. [Ref. 6] This spawned a commercial product [Ref. 7].

In 2005, the Zettl group constructed a molecular actuator able to reversibly push apart two carbon nanotubes [Ref. 8]. Mobile atoms of indium formed a nanocrystal ram between two nanotube electrodes under an applied voltage.

- Variable distance between nanotubes, 0-150 nm
- Cross-sectional area of nanocrystal,  $36\text{ nm}^2$
- Force, 2.6 nN
- Extension velocity,  $>1900\text{ nm/s}$
- Power, 5 fW
- Power density,  $20\text{ MW/m}^3 - 8\text{ GW/m}^3$

Using similar methods, the size of liquid droplets of indium on a nanotube surface could be controlled by varying the electrical current through the nanotube [Ref. 9]. These droplets are capable of exerting pressure in an oscillating manner (peak power,  $20\mu\text{W}$ , peak force 50 nN). Mechanical devices based on levers or plates attached to the droplets or nanocrystal ram could be used to convert electricity into repetitive linear motion. Again, these devices are individually addressable.

## Photonic Nanomotors and Nanoactuators

Another class of nanomotors is that which can be controlled by photons (light and magnetic fields). There are a considerable number of examples of molecules that can be caused to rotate or change conformation with photons; see [Ref. 2] for a comprehensive review and [Refs. 10, 11] for noteworthy examples. In the pathway to APM, nanosystems made from these devices may be driven by arrays of motors performing operations in parallel. A broadcast of electromagnetic radiation onto the motors would provide energy for the array, which could be controlled by modulating the frequency and amplitude of the radiation.

### *Nanocar*

One of the most prominent examples of the application of this technology is the Rice U. Nanocar (and its evolving product line of wheelbarrows and trucks) [Ref. 12]. What distinguishes this effort is that a Feringa motor, which powers the device, was successfully integrated with other molecular structures to create a molecular machine. The motor rotates and pushes a protruding molecular group against the substrate propelling the molecular car forward along an atomically flat surface under 365nm wavelength light. While the utility of this particular application may or may not lead to APM, it shows that a Feringa motor (which had also been used to rotate glass rods on the surface of a liquid crystal [Ref. 13]) can be connected to a device in order to effect directed motion. One can envision alternative configurations such as Feringa motors pushing against gear teeth to rotate a shaft, or provide linear motion as in a rack and pinion.

### *Molecular Valve*

In another example, in 2005 researchers at the Biomade Technology Foundation and the University of Groningen developed a molecular valve controlled by light [Ref. 14]. To do this, they modified a protein found in *e. coli* bacteria that in nature serves as a safety valve for excessive pressure in the cell. The modifications allow it to be opened by UV light (366 nm wavelength, applied for about 2 minutes) and closed by visible light (>460 nm, for about 2 seconds) by building up and releasing localized charge. The valve operates within a lipid bilayer, is about 10 nm in external

diameter, 21 nm long [Ref. 15], and has an internal pore size of 3 nm when open. When the valve is closed it resists being forced open under pressure to nearly the breaking point of the cell wall. Although the valve has been developed and tested in an open system—embedded in the lipid bilayer of a cell wall, or more accurately, a patch clamp to measure current within this environment—one can envision fluid channels (pipes) leading to and from the valve in order to have it regulate fluid or gas transport in a closed system.

## Chemical Nanomotors and Nanoactuators.

A third class of devices are those that respond to chemical changes in their environment, or rely on chemical fuel. As with light-controlled devices, actuators that respond to changes in environmental chemistry have been demonstrated for a broadcast architecture where large numbers of devices are controlled simultaneously. While near-term applications of these chemical nanoactuators may provide some utility, it is unclear whether a system design that modulates a changing chemical environment would be competitive with electric and light-activated designs.

By contrast, biological molecular motors that rely on chemical fuel pose some interesting advantages for the development of APM:

- Biomotors derived from living systems are available now, and can be produced in quantity.
- Most have been proven to work outside the living cell, for example mounted on glass slides.
- They are potentially individually addressable, by direct channeling of fuel to the motor input region via molecular tubes.
- The average motor speed can be modulated by controlling the feed rate of fuel (or, in a broadcast system, by controlling the concentration of fuel in solution).
- Biomotors can be connected to other components to drive the motion of a nanosystem. In the case of the flagellar motor, flagellar hooks are natural points of attachment.

Data on the characteristics of various types of biomotors are compared in Table 1. The highest speeds and forces are provided by the flagellar motors.

**Table 1. Electromechanical characteristics of biomotors. After Berry [Ref. 16].**

Motor	Max Force	Max Speed	Max Power
<b>Rotary</b>			
Flagellar motor (8 units, <i>E. coli</i> )	2400 pN-nm 95 pN	300 Hz 35 $\mu\text{m/s}$	2000 pN-nm @ 150 Hz 1.9x10 <sup>6</sup> pN-nm/s
( <i>Vibrio</i> )		1700 Hz 220 $\mu\text{m/s}$	
(single unit)	300 pN-nm 12 pN	300 Hz 35 $\mu\text{m/s}$	250 pN-nm @ 150 Hz 2.4x10 <sup>5</sup> pN-nm/s
F1-ATPase	40 pN-nm 40 pN	150 Hz 0.9 $\mu\text{m/s}$	20 pN-nm @ 75 Hz 9x10 <sup>3</sup> pN-nm/s
<b>Linear</b>			
Myosin (single molecule in muscle or in vitro)	6 pN	10 $\mu\text{m/s}$ (speed of array, each molecule mostly detached)	2 pN @ 10/s x 20 nm 400 pN-nm/s
Kinesin	5 pN	1 $\mu\text{m/s}$	2.5 pN @ 0.5 $\mu\text{m/s}$ 1.25 x 10 <sup>3</sup> pN-nm/s
RNA polymerase	20 pN	0.01 $\mu\text{m/s}$	~200 pN-nm/s

### *Biomotors Connected to Inorganic Structures*

In 2000, Soong, et al. in Montemagno's group reported the successful integration of a F<sub>1</sub>-ATPase biomotor with a nickel substrate and a nickel propeller [17]. The motor, which measured ~8nm in diameter x 14 nm in length, was able to move the propellers (150 nm diameter x 750-1400 nm long) at a mean velocity of 4.8 rps. The calculated torque was about 20 pN-nm, and the energy usage was 119 to 125 pN-nm/revolution with an estimated efficiency of ~80%. In this study, the yield of working propellers was low—five out of 400 propellers in the array were able to turn when the ATP fuel was introduced into the surrounding environment. The pathway significance of this work was the demonstration that a biomotor could be used to move a structural component in a molecular mechanical system.

Bacteria flagella are powered by a motor that is driven by the flow of ions (protons or Na<sup>+</sup>) across a membrane. These biomotors have been the subject of much study [18], although the exact mechanism of the conversion of ion flow into mechanical motion is still not fully understood. The flagellar motor measures about 45 nm in diameter, can rotate up to 20,000 rpm, and has the additional characteristics shown in Table 2 [Ref. 19].

**Table 2. Electromechanical characteristics of flagellar motors. After Berry [Ref. 16].**

Driving Force	Proton or sodium electrochemical gradient
Number of Protons per revolution	~ 1000
Energy per proton	~ 2.5 x 10 <sup>-20</sup> J (6kT)
Maximum rotation rate	300 Hz (protons) 1700 Hz (sodium)
Torque at stall	~ 4 x 10 <sup>-18</sup> Nm
Maximum power output	~ 10 <sup>-15</sup> W
Efficiency	50 to 100% (stall) ~ 5% (swimming cell)
Number of steps per revolution	~ 50 per torque generator

Flagellar motor torque is dependent on both speed and temperature, as shown in Figure 1.

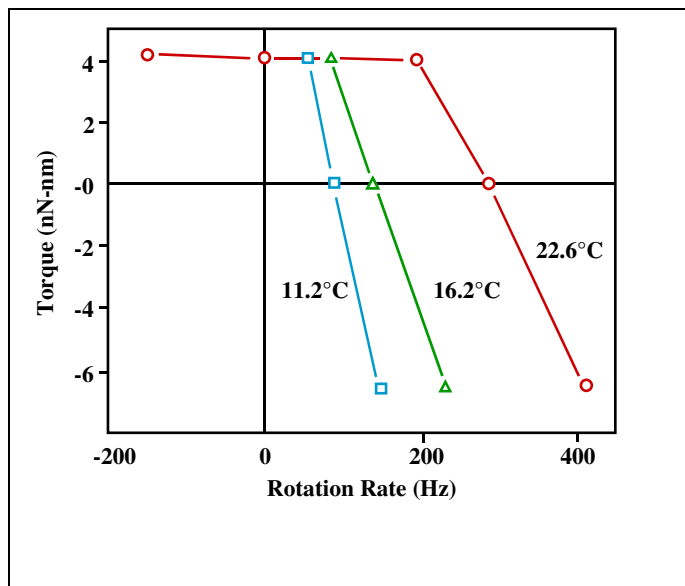

**Figure 1. Torque vs. Rotation Rate curves for the bacterial flagellar motor. After Berry [Ref. 19]**

In order to study the mechanics of flagellar motors, researchers have attached small beads to truncated flagella and measured speeds and torques under various operating conditions [Ref. 19, 20]. While this has proven to be an excellent tool for the intended research, from our perspective it proves that nanostructures can be attached to and driven by flagellar motors. Furthermore, research has proven that speed can be modulated, and even reversed, although methods to improve the precision of this control may be an area for development.

### Chemical Actuator Example

In 2005, Stoddart's group developed a molecular seal based on a pseudo-rotaxane molecule [Ref. 21]. The molecular device effectively sealed nanopores measuring 1.5-2.0 nm diameter on silica spheres, trapping guest molecules Ir(ppy)<sub>3</sub> and Rhodamine B (which measure about 1nm in diameter) in the pores with variable efficiency. Adding an iron salt via solution in the environment moved the QBPQT<sup>4+</sup> ring component of the rotaxane (the stopper) down to the surface, closing the pores and preventing the guest molecules from leaving. Adding ascorbic acid moved the rings away from the pores, opening the pores and releasing the guest molecules to the environment or allowing them back in. There was no estimate of the effective force keeping the pores closed; containment efficiency was related to the depth of attachment of the DNP unit of the molecule within the nanopores. In their second paper [Ref. 22], the group reported pH-driven control of the seals, and their most recent paper updating this work is [Ref. 23]. Although the authors refer to their device as a nanovalve, a "molecular

seal" is a more accurate label, since a valve "is a device that regulates the flow of substances. . . by opening, closing, or partially obstructing various passageways" [Ref. 24]. In this case, the action is more akin to corking and uncorking a bottle.

## Molecular Mechanical Devices

In 1981 Drexler [Ref. 25] observed that biological molecular machines and devices were functionally equivalent to macroscopic parts such as motors, bearings, pipes, drive shafts, and so forth. It is beyond the scope of this section to provide a listing of existing biological nanomechanical devices, so here we focus on the synthetic work that is being performed to create and integrate these devices—with particular regard to efforts that are most relevant to the molecular machine pathway in our Roadmap.

### Molecular Bearings

Nested carbon nanotubes are a natural choice for a sleeve bearing, because they can rotate freely against each other. Measurements of the intershell friction show that the static (0.2 to 0.85 MPa) and dynamic (0.43 MPa) friction are very low [Ref. 26-28]. The utility of a nested carbon nanotube bearing was proven in a working device—the molecular motor cited earlier [Ref. 3]. While there have been proposals to use nested carbon nanotubes as molecular oscillators and telescoping arms [Ref. 29-31], to date there have not been any experimental realizations of a method to drive the motion of the inner or outer tubes.

### Nanosprings

As Cumings and Zettl showed [Ref. 26], there is a restorative force between shells in carbon nanotubes due to Van der Waals forces. In the case of one nanotube on which they performed experiments, the force was calculated to be 9 nN when they used a manipulator to pull an inner nanotube out of its nested environment. Thus, a nested carbon nanotube can provide a spring-like force, but unlike a traditional Hookean spring, the nanotube force is constant (except for at the rest position) and does not increase with the length of extension.

Williams, et al. showed that multi-wall carbon nanotubes can act as torsional springs, as well [Ref. 32]. They used lithographic methods to fabricate paddles, or torsional levers, onto nanotubes suspended at each end. From AFM measurements, for a 7.8 nm, 10 wall nanotube, they determined that the torsional spring constant was  $1.5 \times 10^{-13}$  N-m. The shear modulus,  $G$ , was estimated to be 600 GPa—close to the theoretical value of 541 GPa. Subsequently, they used an applied voltage to impart an oscillating motion to  $\sim 600 \times 500$  nm paddles [Ref. 33]. The paddles were oscillated at various frequencies up to about 9 MHz.



Intershell coupling varied considerably between the nanotubes, resulting in torsional spring constants ranging from  $0.37 \times 10^{-14}$  to  $7.4 \times 10^{-14}$  N-m.

## Conclusions

We have seen from the range of examples above that some types of components that would be useful in an advanced nanosystem have already been either fabricated or isolated from biological systems. This is significant with respect to issues of both feasibility and timeline: groups are building molecular machines now.

The motors are powerful enough, and the machine components are efficient enough, to drive complex systems of molecular mechanical devices and perform useful operations at the nanoscale.<sup>2</sup> Carbon nanotubes have proven to be quite versatile as both structural and multi-functional materials, however, variability in nanotube properties can cause large variations in the performance of nanotube devices. While there has been considerable progress in the fabrication and study of individual components, significantly more progress toward the integration of various types of components into more complex systems is needed. For example, a useful advance would be the introduction of gears to convert rotary motion into linear motion.

More advanced manipulation and construction tools are required to achieve this level of sophistication: the increased complexity means moving from a two-dimensional to a

three-dimensional architecture. (For example, a simple rack and pinion operates on two separate planes.) We can envision that multiple manipulators, or some form of three-dimensional scaffolding, will likely be required to hold components in place on these multiple planes during the construction process.

Therefore, high priority targets for new and ongoing research initiatives are:

- Device uniformity and standardization. Methods to reduce defects in carbon nanotubes would enable devices with more consistent performance. In addition, the development of standard devices and interfaces would enable experimentation with systems of devices.
- Component integration. Ongoing research to improve actuators and motors should be coupled with research to integrate these devices with other components to perform more complex nanomechanical operations.
- Three-dimensional fabrication. Instrumentation to manipulate and fabricate devices in three dimensions is critical to this pathway. New methods to section and join nanomaterials in 3D structures are needed, and 3D scaffolding (to support nanotubes, in particular) would be an important advance.

Table 3 provides a summary of representative molecular motors, actuators, and mechanical devices.

---

<sup>2</sup> We have in mind mechanical operations of the types illustrated on the NanoRex website, <http://nanoengineer-1.com/content/>

**Table 3. Representative molecular motors, actuators, and mechanical devices.**

Molecular Device	Function	Representative Reference
Nanotube Nanomotor	Motor with MWNT serving as a bearing for the rotor and as an electrical conductor	A. M. Fennimore, T. D. Yuzvinsky, Wei-Qiang Han, M. S. Fuhrer, J. Cumings, and A. Zettl, "Rotational actuators based on carbon nanotubes," <i>Nature</i> (July 24, 2003) <b>424</b> : 408-410
Molecular Actuator	Molecular actuator able to reversibly push apart two carbon nanotubes	B.C. Regan, S. Aloni, K. Jensen, R.O. Ritchie and A. Zettl, "Nanocrystal-Powered Nanomotor," <i>Nano Letters</i> (2005) <b>5</b> : 1730-1733.
Molecular Seal	Nanoseal that can be opened and closed at will to trap and release molecules – can be triggered and reversed by redox chemistry or changes in pH	Nguyen TD, Liu Y, Saha S, Leung KC, Stoddart JF, Zink JJ., "Design and optimization of molecular nanovalves based on redox-switchable bistable rotaxanes." <i>J Am Chem Soc.</i> (Jan 24, 2007) <b>129</b> (3):626-34
Molecular Bearings	Nearly frictionless bearing made from two co-rotating nested nanotubes	Cummings, J.; Zettl, A. " Low-Friction Nanoscale Linear Bearing Realized from Multiwall Carbon Nanotubes," <i>Science</i> (2000) <b>289</b> : 602-604.
Nanosprings	Lithographic methods were used to fabricate paddles or levers, onto multi-wall carbon nanotubes acting as torsional springs	P. A. Williams, S. J. Papadakis, A. M. Patel, M. R. Falvo, S. Washburn, and R. Superfine, "Fabrication of nanometer-scale mechanical devices incorporating individual multiwalled carbon nanotubes as torsional springs." <i>Applied Physics Letters</i> (3 Feb 2003), Vol. 82, No. 5: 805-807.
Telescoping Arms	Manipulator capable of extending the inner nanotube in a MWNT	Cummings and Zettl, "Low-Friction Nanoscale Linear Bearing Realized from Multiwall Carbon Nanotubes." <i>Science</i> (2000) <b>289</b> : 602-604
Biomotors [see also Table 1]	Molecular motors evolved by nature that perform a variety of mechanical tasks	Montemagno, C. D., and Bachand, G. D., "Constructing nanomechanical devices powered by biomolecular motors." <i>Nanotechnology</i> (1999) <b>10</b> : 225-331
Radio Frequency Controlled Biomolecules	Nanocrystals attached to biomolecules cause DNA to unzip and rejoin under RF control	K. Hamad-Schifferli, J.J. Schwartz, A.T. Santos, S. Zhang and J.M. Jacobson, <i>Nature</i> (2002) <b>415</b> , 152; <a href="http://www.nature.com/nlink/v415/n6868/abs/415152a_fs.html">http://www.nature.com/nlink/v415/n6868/abs/415152a_fs.html</a>
"Nanocar"	Molecular Feringa motor rotates and pushes a protruding molecular group against a substrate, propelling a molecular chassis forward along an atomically flat surface, powered by 365nm wavelength light	Shirai Y, Morin JF, Sasaki T, Guerrero JM, Tour JM, "Recent progress on nanovehicles." <i>Chem Soc Rev.</i> (Nov. 2006) <b>35</b> (11):1043-55
Microgenerator	Prototype nanotube-based (micron-scale) generator that produces continuous direct-current electricity by harvesting mechanical energy from ultrasonic acoustic waves	X. Wang, J. Song, J. Liu, Z.L. Wang, "Direct-current nanogenerator driven by ultrasonic waves." <i>Science</i> <b>316</b> (6 April 2007):102-105
DNA-based Robotic Arm	DNA-based robot arm inserted into a 2D array substrate and verified by atomic force microscopy to be a functional nanomechanical device with a fixed frame of reference	Ding B, Seeman NC., "Operation of a DNA robot arm inserted into a 2D DNA crystalline substrate." <i>Science</i> (Dec 8, 2006) <b>314</b> (5805): 1583-5
Molecular Carrier	A molecule called 9,10-dithioanthracene (DTA) with two "feet" configured so that only one foot at a time can rest on the substrate. Activated by heat or mechanical force, DTA will pull up one foot, put down the other, and walk in a line across a flat surface w/o tracks. Can carry molecular payloads of Co <sup>2+</sup> .	Wong KL, Pawin G, Kwon KY, Lin X, Jiao T, Solanki U, Fawcett RH, Bartels L, Stolbov S, Rahman TS., "A molecule carrier." <i>Science</i> (Mar 9, 2007) <b>315</b> (5817):1391-3.

Molecular Device	Function	Representative Reference
Light-driven Rotaxane-based Motor	Motor resembles a dumbbell roughly 6 nanometers long that threads a ring about 1.3 nanometers wide. The ring can move up and down the rod of the dumbbell but cannot go past the stoppers at its ends. There are two sites on the dumbbell's rod that the ring encircles. When one of the dumbbell's stoppers absorbs sunlight, it transfers an electron to one of these sites, driving the ring to shuffle to the other site. The ring returns to the old site after the electron transfers back to the stopper, allowing the cycle to repeat	Balzani V, Clemente-León M, Credi A, Ferrer B, Venturi M, Flood AH, Stoddart JF., "Autonomous artificial nanomotor powered by sunlight." <i>Proc Natl Acad Sci U S A</i> . (Jan 31, 2006) <b>103</b> (5):1178-83
Molecular Rack and Pinion	A STM tip drives a single 1.8-nm-diameter pinion molecule functioning as a six-toothed wheel interlocked at the edge of a self-assembled molecular island acting as a rack. The rotation of the pinion molecule is monitored by a chemical tag on one cog.	Franco Chiaravalloti, Leo Gross, Karl-Heinz Rieder, Sladjana M. Stojkovic, André Gourdon, Christian Joachim, Francesca Moresco, "A rack-and-pinion device at the molecular scale," <i>Nature Materials</i> (2007) <b>6</b> , 30–33; <a href="http://www.nature.com/nmat/journal/v6/n1/abs/nmat1802.html">http://www.nature.com/nmat/journal/v6/n1/abs/nmat1802.html</a>
Chemically Powered Nanodimer	A nanodimer comprises two linked spheres, one of which has equal interactions with A and B solvent species but catalyzes the reaction A→B. The other sphere is not chemically active but interacts differently with the two species. The nonequilibrium concentration gradient generated at the catalytic end, in conjunction with the force difference at the noncatalytic end, leads to directed motion.	Rückner G, Kapral R., "Chemically powered nanodimers." <i>Phys Rev Lett</i> . (Apr 13, 2007) <b>98</b> (15):150603.

## References

- [1] K. E. Drexler. *Nanosystems: Molecular Machinery, Manufacturing, and Computation*, John Wiley & Sons, Inc.: New York (1992).
- [2] E. R. Kay, D. A. Leigh, and F. Zerbetto. "Synthetic Molecular Motors and Mechanical Machines." *Angew. Chem. Int. Ed.* (2007) **46**: 72-191.
- [3] A. M. Fennimore, T. D. Yuzvinsky, Wei-Qiang Han, M. S. Fuhrer, J. Cumings, and A. Zettl. "Rotational actuators based on carbon nanotubes." *Nature* (July 24, 2003) **424**: 408-410. See also [http://www.berkeley.edu/news/media/releases/2003/07/23\\_motor.shtml](http://www.berkeley.edu/news/media/releases/2003/07/23_motor.shtml) [http://www.berkeley.edu/news/media/releases/2003/07/video/nano\\_bband.mov](http://www.berkeley.edu/news/media/releases/2003/07/video/nano_bband.mov) <http://www.lbl.gov/Science-Articles/Research-Review/Magazine/2001/Fall/features/02Nanotubes.html>
- [4] J. Cumings, P.G. Collins, and A. Zettl. "Peeling and sharpening multiwall nanotubes," *Nature* (2000) **406**: 586.
- [5] T. D. Yuzvinsky, A. M. Fennimore, W. Mickelson, C. Esquivias and A. Zettl. "Precision cutting of nanotubes with a low-energy electron beam." *Appl. Phys. Lett.* (2005) **86**: 053109; and Erratum, *Appl. Phys. Lett.* (2005) **87**: 069902.
- [6] John Cumings and A. Zettl. "Low-Friction Nanoscale Linear Bearing Realized from Multiwall Carbon Nanotubes." *Science* (2000) **289**: 602-604.
- [7] <http://www.hummingbirdscientific.com/>. In addition, nanomanipulators are available from NanoFactory Instruments (<http://www.nanofactory.com/>), Omicron (<http://www.omicron-instruments.com/>), and Zyvex (<http://www.zyvex.com>).
- [8] B.C. Regan, S. Aloni, K. Jensen, R.O. Ritchie and A. Zettl, "Nanocrystal-Powered Nanomotor." *Nano Letters* (2005) **5**: 1730-1733.
- [9] B.C. Regan, S. Aloni, K. Jensen, and A. Zettl, "Surface-tension-driven nanoelectromechanical relaxation oscillator." *Appl. Phys. Lett.* (2005) **86**: 123119.
- [10] T. R. Kelly (Editor), *Molecular Machines*, *Topics in Current Chemistry*. Springer Verlag, Heidelberg, 2005, Vol. 262.
- [11] Sauvage, J.-P. (Ed.). *Molecular Machines and Motors, Series: Structure and Bonding*. Springer Verlag, Heidelberg, 2001, Vol. 99. ISBN: 978-3-540-41382-0.
- [12] Y. Shira, J.-F. Morin, T. Sasaki, J. Guerrero, and J. M. Tour. "Recent Progress on Nanovehicles." *Chem. Soc. Rev.* (2006) **35**: 1043-1055.

- [13] Liz Kalaugher. "Molecular motor rotates objects 10,000 times its size." *Nanotech Web*, 8 March 2006. <http://nanotechweb.org/articles/news/5/3/6/1>
- [14] Armagan Kocer, Martin Walko, Wim Meijberg, and Ben L. Feringa. "A Light-Actuated Nanovalve Derived from a Channel Protein." *Science*, (2005) **309** (5735): 755-757.
- [15] <http://www.pdb.org/pdb/explore.do?structureId=2OAR>
- [16] [www.nanoforum.org/events/files/Richard Berry.pdf](http://www.nanoforum.org/events/files/Richard%20Berry.pdf)
- [17] Ricky K. Soong, George D. Bachand, Hercules P. Neves, Anatoli G. Olkhovets, Harold G. Craighead, and Carlo D. Montemagno. "Powering an Inorganic Nanodevice with a Biomolecular Motor," *Science* Vol. 290, No. 5496 (24 November 2000): 1555 – 1558.
- [18] Sources include:  
Oxford Molecular Motors  
<http://www.physics.ox.ac.uk/biophysics/intro.html>  
Osaka U. Protonic Nanomachine Group  
<http://www.fbs.osaka-u.ac.jp/eng/labo/09a.html>  
Protonic Nanomachine Project <http://www.npn.jst.go.jp/>  
(video)  
<http://www.nanonet.go.jp/english/mailmag/2004/files/011a.wmv>  
(assembly animation)  
<http://www.npn.jst.go.jp/movie5.html>
- [19] <http://www.physics.ox.ac.uk/biophysics/research/flagellar.html>
- [20] <http://www.npn.jst.go.jp/> (click on Nano Mechanics Group Overview)  
<http://www.npn.jst.go.jp/movie4.html> (animation of fluorescent bead)
- [21] Thoi D. Nguyen, Hsian-Rong Tseng, Paul C. Celestre, Amar H. Flood, Yi Liu, J. Fraser Stoddart, and Jeffrey I. Zink. "A reversible molecular valve," *PNAS* **102** (2005): 10029-10034.
- [22] T. D. Nguyen, K. C. Leung, M. Liong, C. D. Pentecost, J. F. Stoddart, and J. I. Zink. "Construction of a pH-driven supramolecular nanovalve." *Org Lett.* (Jul 20, 2006) **8**(15):3363-6.
- [23] T. D. Nguyen, Y. Liu, S. Saha, K. C. Leung, J. F. Stoddart, and J. I. Zink. Design and optimization of molecular nanovalves based on redox-switchable bistable rotaxanes. *J Am Chem Soc.* (Jan 24, 2007) **129**(3): 626-34.
- [24] <http://en.wikipedia.org/wiki/Valve>
- [25] K. Eric Drexler. "Molecular engineering: An approach to the development of general capabilities for molecular manipulation," *Proceedings of the National Academy of Sciences* (September 1, 1981), Vol. 78, No. 9, p. 5275-5278.
- [26] J. Cumings, and A. Zettl. "Low-Friction Nanoscale Linear Bearing Realized from Multiwall Carbon Nanotubes." *Science* (2000) **289**: 602-604.
- [27] M. F. Yu, B. I. Yakobson, and R.S.J. Ruoff. *Phys. Chem. B* (2000) **104**: 8764.
- [28] Bertrand Bourlon, D. Christian Glattli, Csilla Miko, Laszlo Forro, and Adrian Bachtold. "Carbon Nanotube Based Bearing for Rotational Motion." *Nano Letters*, Vol. 4, No. 4 (2004): 709-712.
- [29] Jeong Won Kang and Ho Jung Hwang. "Gigahertz actuator of multiwall carbon nanotube encapsulating metallic ions: molecular dynamics simulations." *Journal of Applied Physics*, Vol. 96, No. 7 (1 Oct 2004): 3900-3905.
- [30] J. W. Kang, K. O. Song, O. K. Kwon, and H. J. Hwang. "Carbon nanotube oscillator operated by thermal expansion of encapsulated gases." *Nanotechnology* **16** (2005): 2670 – 2676.
- [31] J. W. Kang, K. O. Song, H. J. Hwang, and Q. Jiang. "Nanotube oscillator based on a short single-walled carbon nanotube bundle." *Nanotechnology* **17** (2006): 2250-2258.
- [32] P. A. Williams, S. J. Papadakis, A. M. Patel, M. R. Falvo, S. Washburn, and R. Superfine. "Fabrication of nanometer-scale mechanical devices incorporating individual multiwalled carbon nanotubes as torsional springs." *Applied Physics Letters*, Vol. 82, No. 5 (3 Feb 2003): 805-807.
- [33] S. J. Papadakis, A. R. Hall, P. A. Williams, L. Vicci, M. R. Falvo, R. Superfine, and S. Washburn. "Resonant Oscillators with Carbon-Nanotube Torsion Springs." *Physical Review Letters*, Vol. 93, No. 14 (1 Oct 2004): 146101.

## Chemotactic Machines

Living cells represent the only existing advanced nanotechnology. So, as aspiring nanotechnologists, we look to living cells for inspiration and goals. For this grand challenge we take inspiration from the cell's talent as a micron-scale mechanism. From nanoscale parts, cells create and integrate sensors, computers, structures, and motors to perform a variety of tasks. Even simple bacterial cells navigate their environment to look for food while simultaneously avoiding dangers such as toxins—a phenomenon known as chemotaxis [Refs. 1, 2]. This grand challenge seeks to replicate bacterial chemotaxis in an artificial system: to make “chemotactic machines.”

Mobile machines with the ability to sense a change in the concentration of a chemical in their environment and to move toward or away from the chemical's source would have many practical applications. Imagine that mobile machines programmed to move toward explosives could be sprayed on a minefield. Swarms of the machines, programmed additionally to begin glowing upon reaching a critical concentration of explosive, could mark the field for mine disposal teams. (While a non-moving glowing agent might similarly indicate the presence of an explosive, the chemotactic machines' ability to move toward the source would amplify a positive signal and increase sensitivity—an increase whose magnitude would depend on the range of the mobile machines.) Chemotactic machines at a waste site could indicate high concentrations of a pollutant and potentially release a remediative agent. Chemotactic machines might indicate the location of natural resources, e.g., finding a new vein of a valuable ore. Or, in a medical setting, chemotactic machines could be programmed to seek out an infection or cancer, and deliver a drug.

Under this challenge, there is much room for variety: there may be chemotactic machines which are “swimmers” in water and others that are “crawlers” on a solid surface. Further, there is much room for development. At first chemotactic machines may work only in highly contrived environments, bathed in a solution of fuel to run their motors—later they may carry some onboard fuel or might be powered by light. Early machines may exhibit only the simplest rules concerning one or two molecules of interest: “If the concentration of food is increasing and the concentration of poison is less than some threshold, keep swimming.” Later machines may include sophisticated logic on numerous analytes that triggers delivery of a payload: “If the presence of five markers for a particular type of cancer cell are present, and three other markers for normal cells below some threshold, burst and deliver a drug.”

Even the most basic chemotaxis task, however, holds significant challenges: it is not possible for a bacterium to measure the concentration on both of its ends and compare

them to decide if it is moving in the right direction or not—the chemical gradients it follows are too shallow for a change to be detected over such a short distance. Instead the bacterium must “remember” the concentration that it experiences as it moves, and essentially compare concentrations measured at two different times. Presumably, our artificial chemotactic machines will have to do the same nontrivial computational task.

A great strength of this grand challenge is that it calls for the development of four core capabilities in nanotechnology—sensing, computation, structure, and motion—without regard to how these capabilities are to be achieved. Thus this grand challenge has great opportunities for creativity and privileges no particular group of nanotechnology researchers. A solution to this grand challenge could come from any of the different schools of nanotechnology now being developed, or it could come from a combination of one or more schools. Here are some examples of how different nanotechnology schools might address the grand challenge.

Synthetic biologists seek to achieve nanotechnology through profound reengineering of existing biological organisms—and perhaps they are the front-runners in a race for chemotactic machines because biology gives them a head start. As an example, the synthetic biology school might start with a bacterium that is already motile (Figure 1a) because it has flagella (green “hair”), and augment that bacterium with artificial genetic regulatory circuits to control when the flagella are to be turned on or off (Figure 1b, black ovals inside cell). Further, the synthetic biologists might collect natural sensing systems from a variety of bacteria to give their bacterium a diverse range of sensors (Figure 1b, colored shapes on cell surface; the blue square binds a red target molecule). Some synthetic biologists have already embarked on such a program. The University of California San Francisco now hosts an NIH Nanomedicine Center, “The Cell Propulsion Lab”, whose own grand challenges would enable the greater challenge of building a chemotactic machine (and their challenges map loosely to the four core capabilities discussed here; see <http://www.qb3.org/cpl/>).

Protein engineers address nanotechnology through the reengineering of natural proteins and de novo engineering of proteins that do not occur in Nature. To achieve a chemotactic machine, the protein school might use natural bacterial flagella (green “hair” in Figure 1c), reconstituted as a power plant on a structural lipid vesicle (large black circle in Figure 1c; for the purpose of creating large scale structure we assume the protein engineers might favor lipids rather than protein). Inside the vesicle they might place an engineered protein kinase signaling cascade for logic to control the flagella (Figure 1c, black arrows inside the



vesicle), and they might stud the outside of the vesicle with engineered protein receptors as sensors (Figure 1c, colored shapes on the vesicle surface whose arrows point to the signaling cascade).

DNA (and RNA) nanotechnologists [Refs. 3, 4, 5] support the thesis that much (but not all) of an advanced nanotechnology may be created using only nucleic acids. Thus the DNA nanotechnology school might use RNA aptamers [Ref. 6] for sensing (Figure 1d, black squiggles shown binding target molecules), DNA origami [Ref. 7] as a supporting structure (Figure 1d, the black mazelike path forming a triangular shape), DNA ribozymes for logic (not shown) [Refs. 8, 9], DNA tubes [Ref. 10] as a flagellum (Figure 1d, black cylinders), and DNA tweezers [Ref. 11] to power the flagellum (Figure 1d, black zig-zags).

Synthetic chemists are building a nanotechnology that begins with building small molecules or clusters of atoms. The synthetic chemistry school might use a metal nanoparticle for structure (Figure 1e, hexagonal shape of yellow metal atoms), studded with cavitand-based [Ref. 12] molecular sensors that bind target molecules (Figure 1e, example crown ether molecule at top; this is not a sensor molecule per se but binding of a target ion/molecule might affect plasmons in the metal particle). The machine might move under the power of light driven molecular motors [Refs. 13, 14] (Figure 1e, rotating molecule at bottom). Logic might be accomplished by molecular electronics or molecular shuttles (not shown, shuttles reviewed in Ref. 14.)

Practitioners of silicon microfabrication seek to extend their techniques to nanofabrication, augmenting decades old photolithography techniques with new methods such as nanoimprint lithography, and adding new materials to their vocabulary such as DNA and protein molecules which provide an interface to biological/organic molecules. Thus the microfabrication school might base their machine around a chip (Figure 1f, logic circuit), with standard logic powered by light or radio frequency. To this they might add a nanomachined cantilever [Refs. 15, 16] bearing protein antibodies that could bind and detect small molecules (Figure 1f, arm with Y-shaped antibodies). Downstream of the logic they might add some kind of nanomachined silicon flippers for locomotion.

None of these examples is meant to be serious in any detail—instead they are merely cartoons meant to suggest that each of the various schools of nanotechnology may have, within the set of tools available to them, the capacity to solve the problems of sensing, computation, structure and motion—sometimes with a little help from one of the other schools.

A first benchmark for the effort would be for each solution to be compared against Nature's solution, that is, a bacterium moving up a chemical gradient. Solutions would be judged by their sensitivity to chemicals of interest, say a simple sugar such as glucose and a repellent such as phenol. Chemotactic assays are well developed for bacteria and can be performed in microfluidic devices—in such devices “races” would be conducted on chemotactic swimmers to judge their performance.

The problems of motion, computation, sensing, and structural organization already face each school of nanotechnology and within a school a particular researcher tends to focus on just a single one of them. For example, in DNA nanotechnology some researchers focus on the sensing of molecules with aptamers, others focus on building unusual DNA structures, while still others focus on making DNA compute or the problem of making DNA move. The challenge of creating a chemotactic machine will force researchers to create interfaces between these different research domains—to transduce the information from the sensors into the computer, to translate the output of the computer into a structural change to create motion. The lessons learned integrating different nanoscale subsystems will lay the groundwork for the engineering of much more complicated nanomechanical systems in the future.

Finally, we note that this grand challenge captures much of what is interesting about the behaviour of living cells, without addressing one of their most difficult aspects: reproduction. It is an entirely different grand challenge to create a self-reproducing nanotechnological system, and that grand challenge comes with dilemmas such as the problem of potential runaway replicators.

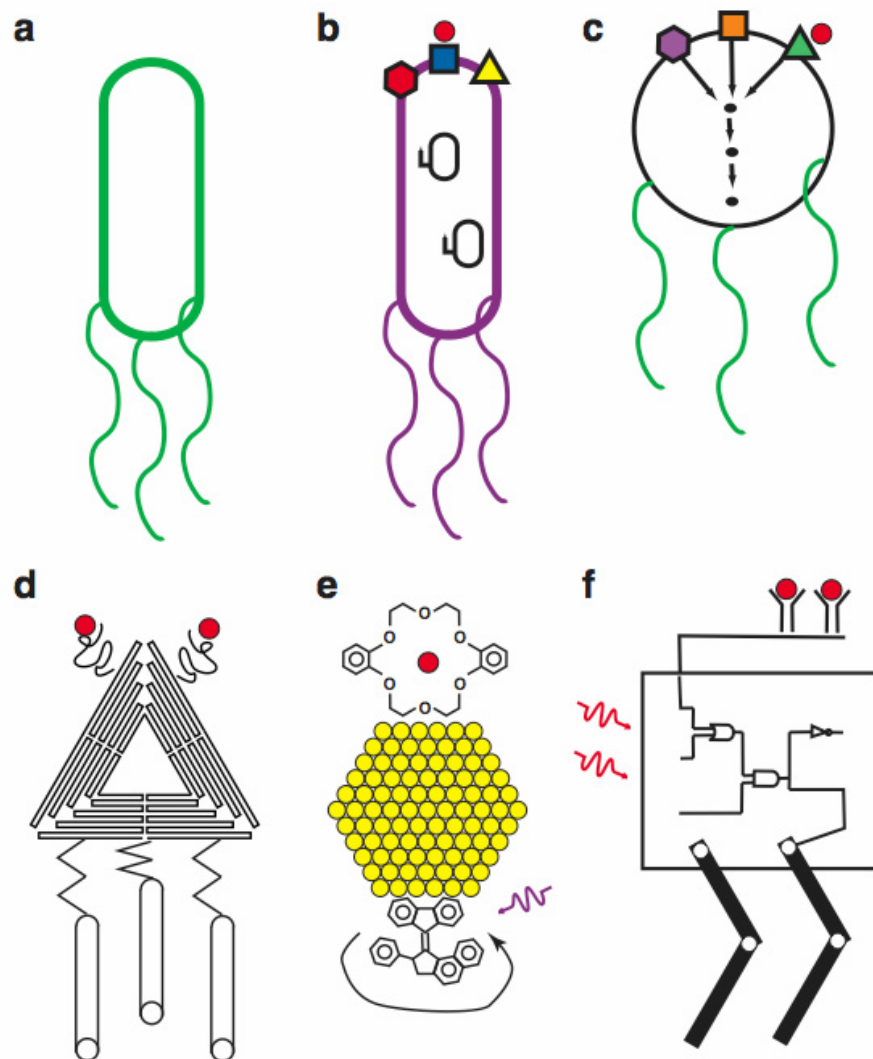

**Figure 1. Approaches to developing chemotactic robots.**  
See text for explanation of lettered diagrams.

## Literature (Lightly Annotated)

The first two references are different types of reviews on bacterial chemotaxis.

1. Bren, Anat and Eisenbach, Michael. How Signals Are Heard during Bacterial Chemotaxis: Protein-Protein Interactions in Sensory Signal Propagation, *Journal of Bacteriology*, December 2000, p. 6865-6873, Vol. 182, No. 24.
2. Baker, M.D., Wolanin, P.M., and Stock J.B. Systems biology of bacterial chemotaxis. *Curr Opin Microbiol.*, 2006, Apr 9 (2):187-92. Epub 2006 Mar 9.

The next two are Seeman's original paper on DNA nanotechnology and a recent review.

3. Seeman, Nadrian C. Nucleic-acid junctions and lattices, *Journal of Theoretical Biology*, 1982, Vol. 99. pp. 237 – 247.
4. Seeman, Nadrian C. and Lukeman, Philip S. Nucleic acid nanostructures: bottom-up control of geometry on the nanoscale, *Rep. Prog. Phys.*, 2005, Vol. 68, pp. 237 – 270.

The following is a good recent review of DNA nanotechnology.

5. Feldkamp, Udo and Niemeyer, Christof M. Rational Design of DNA Nanoarchitectures, *Angew. Chem. Int. Ed.*, 2006, 45, 1856 – 1876.
6. Breaker, Ron .R. Engineered allosteric ribozymes as biosensor components, *Curr. Opin. Biotechnol.*, 2002, Vol. 13:31-39

Origami for structure:

7. Rothemund, P.W.K. Folding DNA to create nanoscale shapes and patterns, *Nature*, 2006, Vol. 440, 297 – 302.

Deoxyribozyme based logic gates for computation:

8. Stojanovic, Milan N., Mitchell, Tiffany Elizabeth, and Stefanovic, Darko. Deoxyribozyme-based logic gates, *JACS*, 2002, Vol. 124, pp. 3555 – 3561.
9. Stojanovic, Milan N. and Stefanovic, Darko. Deoxyribozyme-based half-adder. *JACS*, 2003, Vol. 125, pp. 6673 – 6676.

DNA tubes for structure:

10. Rothemund, P.W.K., Ekani-Nkodo, A., Papadakis, N., Kumar, A., Fygenson, D.K., and Winfree, E. Design and Characterization of Programmable {DNA} Nanotubes, *Journal of the American Chemical Society*, 2004, Vol. 26, No. 50, pp. 16344 – 16353.

A DNA machine that behaves like “tweezers” for motion:

11. Yurke, B., Turberfield, A.J., Mills, Jr., A.P., Simmel, F.C., and Neumann, J.L. A DNA-Fuelled Molecular Machine Made of DNA, *Nature*, 2000, Vol. 406, pp. 605 – 608.

A review of cavitands, potential sensors:

12. Sliwa, W., and Deska, M. Cavitands, *Chemistry of Heterocyclic Compounds*, Volume 38, Number 6 / June, 2002, pp. 646 – 667.

A light driven molecular motor:

13. Eelkema, RienkPollard, Michael M Vicario, Javier, Katsonis, Nathalie, Serrano Ramon, Blanca, Broer, Dirk J., and Feringa, Ben L. Nanomotor rotates microscale objects, *Nature*, March 9, 2006, Vol. 440, p. 163.

A review of the chemistry approach to molecular machines:

14. Browne1, Wesley R., and Feringa1, Ben L. Making molecular machines work, *Nature Nanotechnology*, 2006, Vol. 1, pp. 25 – 35.

Two papers on cantilever mass sensors:

15. Gupta, A., Akin, D., and Bashir, R. Single virus particle mass detection using microresonators with nanoscale thickness, *Applied Physics Letters*, March 15, 2004, Volume 84, Issue 11, pp. 1976 - 1978.
16. Hosaka, Sumio, Chiyoma, Takafumi, Ikeuchi, Ayumi, Okano, Haruki, Sone, Hayato and Izumi, Takashi. Possibility of a femtogram mass biosensor using a self-sensing cantilever, *Current Applied Physics*, June 2006, Volume 6, Issue 3 , pp. 384 – 388.

## Atomistic Modeling of Nanoscale Systems

### Background

Achieving the promise of nanoscale science and technology will require a new generation of computational tools. As computers have become more powerful, the opportunity to develop a truly predictive design methodology at the nanoscale has emerged. Yet most current computational models do not deal with nanoscale objects – which typically contain  $\sim 10,000$  atoms or more. High-end computers (supercomputers) are facing difficult challenges as well. The steady increase in clock speed which has characterized processor performance for decades has ended; the semiconductor industry is moving to multiple cores (dual, quad, hundreds). The only way to achieve extreme performance is to employ massively parallel arrays of multi-core processors. These can and will be used to model productive nanosystems, but new codes and algorithms as well as new optimization strategies will need to be developed.

### Typical Nanosystems

It is useful to remember that typical nanoparticles contain roughly 5000 atoms. For example, the atomic density of cobalt is 89 atoms/nm<sup>3</sup> and that of gold is 59 atoms/nm<sup>3</sup>. So a five-nanometer diameter cobalt particle will contain 5825 atoms, one of gold 3860. The molecular density of water is 33 molecules/nm<sup>3</sup>, so a 5-nm drop contains 2160 molecules, or 6480 atoms. A typical protein might contain 3000 atoms, but the need to surround the protein in water would add an additional 20,000 atoms. Recently Dumestre et al. [1] have reported the synthesis of arrays of nearly perfect iron nanocubes 7 nm on a side. Each nanocube would contain approximately 30,000 atoms.

An alternative geometry of great importance is the thin film. These have in many ways greater usability, since techniques for fabricating multilayer films with one to thousands of layers are well developed. It seems likely that in the near term the best atomic control will be obtained with films. And in any case, clusters need to be supported in order to be useful. An example of a calculation on a film is given in figure 1 which shows the spin (magnetization) density for an array of cobalt atoms on a platinum surface [2].

### Computational Tools

The essence of nanoscale science and technology is the precise control of atom placement. Nanostructures contain a small enough number of atoms that quantum size effects (quantum confinement) are important. Indeed, it is the very fact that such properties as chemical reactivity, optical absorption, and magnetization are different at the nanoscale,

and controllable, that makes nanoscale objects so revolutionary. In addition, many biological systems, proteins and viruses for example, are of nanometer size so the impact of an accurate computational methodology in biology will be revolutionary as well.

Quantum mechanics of course provides in principle a complete system of equations capable of predicting all of the properties of a system regardless of its size. However, as is well known, complete solution of the quantum equations requires an exponentially larger number of mathematical operations as the system size increases. This restriction is such that complete solutions are only available for molecules with a few tens of atoms, well below the nanoscale. In the last several decades an approximate version of quantum mechanics known as density functional theory (DFT) has been developed, for which Walter Kohn shared the Nobel prize in Chemistry in 1998 [3]. In its usual implementation DFT calculations scale as  $N^3$  ( $N$  is the number of atoms), a major improvement over exact solutions but still short of the nanoscale; currently DFT calculations are practical for  $\sim 1000$  atoms. However, it is likely that with advances in computing power these can be extended to the 10,000-atom range in the not too distant future. The price for this expansion in system size is a loss of accuracy. DFT calculations have been remarkably successful in predicting geometrical structures (better than 0.01 nm) and relative (equilibrium) bond energies but are generally not of sufficient accuracy to predict absolute bond energies or energy barriers (which would be needed to predict reaction rates). More accurate but approximate methods are in use by the quantum chemistry community, such as coupled cluster theory [4], but this scales as  $N^7$  and so will likely not reach the nanoscale without further approximation. Finally, there are promising techniques available [5] for the further development of DFT calculations which would scale linearly with  $N$  — these are especially promising. For further details see [6].

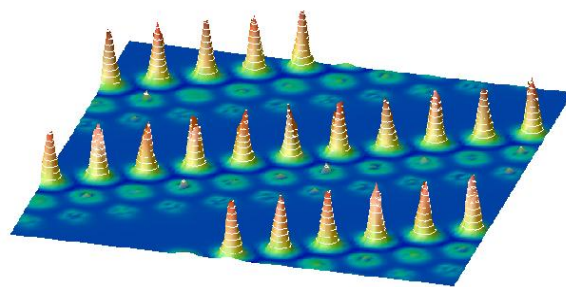

**Figure 1.** Calculated spin density of cobalt atoms on vicinal platinum surface.

Many will be more familiar with classical molecular dynamics (MD) calculations which are often performed on systems such as proteins embedded in water. For these Newton's law is used to advance the position of each atom in the simulation. This of course requires the forces on the atoms, and elaborate force fields have been developed using a mixture of experiment and (quantum mechanical) theory. For example, if a DFT calculation were performed on, say a glucose molecule, one of the outputs would be the forces on the individual atoms as a function of the atomic geometry. At equilibrium all these forces vanish (which is the definition of equilibrium), but for displacements from equilibrium the forces do not vanish. It is these forces which would enter into a molecular dynamics calculation. These force fields are quite complicated and contain many parameters. The simulated time is the time per step times the number of steps. The time per step is determined by the fastest vibrational frequencies and is usually  $10^{-15}$  seconds. Current hardware limits the number of steps to around  $10^6$ . So the simulated time is typically 1 nanosecond. Next generation machines will likely extend this by two to three orders of magnitude, approaching microseconds of simulated time. Still, this is less than one would like for many applications. An alternate approach, which is scalable to massively parallel machines, is to run a large number of replicas of the same system with different random starting configurations [7]. Such replicas can also be used to calculate the free energy of a cluster. For more information on classical molecular dynamics simulations see [8].

## First Principles Molecular Dynamics

It is also possible to combine quantum mechanics with molecular dynamics by computing the forces "on the fly" at each time step in a molecular dynamics simulation. The forces are then determined by the quantum mechanical motion of the electrons, but the ions' motion is governed by classical mechanics. This approach was pioneered by Roberto Car and Michele Parrinello and is widely known by their names [9]. A recent example of this kind of calculation is the study by Raty, Gygi, and Galli [10, 11] of the formation of carbon clusters which resemble the caps of carbon nanotubes in the presence of a nanometer-sized iron cluster. Raty et al. show the growth of tubelike carbon structures when in contact with iron. Similar growth does not occur in the presence of a comparably sized gold cluster. These simulations are relatively short by MD standards — only a few picoseconds — but they illustrate the remarkable power of first principles methods with no adjustable force parameters to describe fundamental processes relevant to a design paradigm for productive nanosystems.

## Multi-Scale Modeling

It should be clear from the previous section that no single theoretical technique can span the length and time scales

required for a quantitative description of nanoscale systems. Thus there will be a priority on developing inter-operative codes for which data can be transferred seamlessly from one to another. For example at the micron scale and larger, well developed continuum mechanics (elasticity, diffusion) are available. As yet the precise limits at the small scale are not known and the parameters in such theories need to be determined, either by calculations at shorter length scales or in some cases by experiment. A recent example of the use of multi-scale modeling to determine the mechanical properties of carbon nanotubes is described by Schatz [12]. This work explored the role of defects in carbon nanotubes in limiting the nanotubes' mechanical strength. Careful consideration of the matching of the different length scales was critical to the success of the approach.

The time scale problem is harder, and models which predict long time behavior (greater than 1 millisecond) are urgently needed.

## Hardware and Software

As indicated earlier, current high end computers make use of very large numbers of processors. For example the fastest machine on the TOP500 list [13] is an IBM Blue Gene/L, located at Lawrence Livermore National Laboratory, which contains 131,000 processor cores. The second is located at Oak Ridge National Laboratory and contains 23,000. The clock speeds on these machines are not different from those on a laptop, so they illustrate the design paradigm for the next decade which is massively parallel processing. The peak performance (maximum possible number of floating point operations per second) is usually in the range of 1 to 10 gigaflops times the number of processor cores. For the Blue Gene/L this is 360 teraflops ( $10^{15}$  flops). Petaflops machines are going to be installed at several institutions in the next several years and exaflops ( $10^{18}$  flops) machines are being contemplated. As a rule of thumb, for many reasons, the sustained performance is typically 10 to 20 % of peak and highly dependent on the particular code.

An added feature of the landscape is the electrical power consumption and associated cooling. Many machines being contemplated require tens of megawatts of power and cooling. The industry is working to reduce power consumption (lower clock speeds and multi-cores are both used) but we may be in an era where the largest machines are located in large centers which can provide the infrastructure.

The kind of software required for this is largely available in standard codes. There has been a large effort over the last decade to make codes parallel so that they can take advantage of these machines, and much progress has been made. Most researchers and most codes, though, have not been scaled to this level (100 to 200 processors being typical). So as these machines become more widely available there is still a need for the community to explore



new ways of adapting codes to take advantage of the unprecedented power which is available.

## What Does a Roadmap Look Like?

It should be clear from the above considerations that a roadmap for atomic modeling and design of productive nanosystems needs to consider the following points:

- Span length and time scales
- Plan for petaflops
- Develop inter-operative codes
- Develop standards for data sharing
- Requires a community effort
- Plan for data storage and retrieval

## Summary

In summary, high end computing is an imperative to develop a design methodology for productive nanosystems. Machines with 1,000 to 10,000 times increases in speed will be delivered in the next few years. Scientists and engineers need to develop the human and computational infrastructure to take advantage of these machines, to extract meaningful conclusions from the massive data sets they will produce, and to share the output in a meaningful way.

## References

1. Superlattices of Iron Nanocubes Synthesized from  $\text{Fe}[\text{N}(\text{SiMe}_3)_2]_2$ . Frédéric Dumestre, Bruno Chaudret, Catherine Amiens, Philippe Renaud, and Peter Fejes. *Science* **303**, 821-823 (2004).
2. From the bulk to monatomic wires: An ab initio study of magnetism in Co systems with various dimensionality. Matej Komelj, Claude Ederer, James W. Davenport, and Manfred Fahnle. *Phys. Rev. B* **66**, 140407(R) (2002).
3. Nobel Lecture: Electronic structure of matter – wave functions and density functionals. Walter Kohn. *Rev. Mod. Phys.* **71**, 1253 (1999).
4. Coupled-cluster theory in quantum chemistry. Rodney Bartlett and Monika Musial. *Rev. Mod. Phys.* **79**, 291 (2007).
5. Linear scaling electronic structure methods. Stephan Goedecker. *Rev. Mod. Phys.* **71**, 1085 (1999).
6. Electronic Structure, Basic Theory and Practical Methods. Richard M. Martin, Cambridge University Press, 2004.
7. Parallel Implementation of the replica exchange molecular dynamics algorithm on Blue Gene/L. M. Eleftheriou, A. Rayshubskiy, J. W. Pitera, B. G. Fitch, R. Zhou, and R. S. Germain. *Fifth IEEE International Workshop on High Performance Computational Biology*, April (2006).
8. Molecular Modeling and Simulation: An Interdisciplinary Guide. Tamar Schlick. Springer-Verlag, 2002.
9. Unified Approach for Molecular Dynamics and Density-Functional Theory. Roberto Car and Michele Parrinello. *Phys. Rev. Lett.* **55**, 2471 (1985).
10. Growth of Carbon Nanotubes on Metal Nanoparticles: A Microscopic Mechanism from *Ab Initio* Molecular Dynamics Simulations. *Phys. Rev. Lett.* **95**, 096103 (2005).
11. EPAPS Document No. E-PRLTAO-95-042535. Available at <http://www.aip.org/pubservs/epaps.html>.
12. Using theory and computation to model nanoscale properties. George C. Schatz. *Proc. Nat. Acad. Sci.* **104**, 6885 (2007).
13. [www.top500.org](http://www.top500.org)



## Productive Nanosystems: Multi-Scale Modeling and Simulation

Nanomanufacturing has been defined as an approach to design, produce, control, modify, manipulate, and assemble nanometer-scale elements or features into products or systems that exploit unique properties seen at the nanoscale. It includes bottom-up directed assembly from atomic molecular or supramolecular building blocks, top-down, high-resolution processing, physico-chemical engineering of molecules by design, and hierarchical integration with larger scale systems.<sup>1</sup>

Self-assembly is a process where higher order materials are generated from simpler molecular building blocks. Computational techniques are important for designing structural and superstructural targets and understanding the noncovalent interactions needed to produce functional nanosystems (see Table 1). Advances in hardware (massively parallel computer clusters) and software (more efficient algorithms) have enabled investigation of larger systems with better accuracy. Density functional quantum mechanical methods now permit accurate prediction of many physical and electronic properties e.g. electron transfer rates, excited states. Molecular dynamics simulations and in particular hybrid computational methods, such as Car-Parrinello molecular dynamics<sup>2</sup> and ONIOM<sup>3</sup> can now be used to study how large ensembles of molecules interact with each other and with surfaces. This is particularly important in patterning and templating functionalized surfaces.

### Objective

The primary goal of this roadmap section is to encourage development and coherent integration of a suite of modeling tools dedicated to the design and fabrication of atomically precise functional nanosystems. This involves developing computational software tools that link nano-meso-macro scales (time, length, and energy). These methods should simultaneously incorporate atomistic (1 to 10 nm) and mesoscale (1 to 10  $\mu\text{m}$ ) and have uniform bridging scales across 9 OM in length, 12 OM in time (and energy flow) and integrate with self-consistent scaling laws. This can involve continued development of large scale MD methods: Lattice-

Boltzman, Dissipative Particle Dynamics, Mesodyn, DFT and Mean Field Theory approaches, as well as, extensions of continuum models back down to nanoscale, currently bridged by QSPR or engineering models (UNIFAC) through experiment. In addition, development of algorithms and infrastructure to handle large scale models, multi-scale physics, and methods to include bond-breaking and forming in a computationally efficient method appropriate for many-atom ( $N > 1000$ ) simulations: REAXX force-field., QM-MD methods must continue. Finally, it would be valuable to develop methods to model chemistry at deformable interfaces during production of nano-structures and understand the thermodynamics and kinetics of ordering.

### Ordered Nanostructures, Hierarchical Self-Assembly and Modeling: Self Organization, Cellular Automata, and Coarse-Grain Hybrid Models

DNA, proteins, block copolymers, dendrimers and sol gels are potentially useful meso-scale components that self assemble. They can form scaffolds upon which nano-assembly can take place or can be used to drive nanoassembly of a nanodevice component in a dynamic fashion. In the near-term, it would accelerate the production of both nanosystems and computational modeling tools to narrow the focus to a subset of functionality dedicated to this area. For example, one could select one or two well-characterized fractions that exhibit the templating behavior of value to a first-generation device component. The protein polymers produced by Tirrell and coworkers (1994) are examples of this new methodology.<sup>4</sup> In one set of experiments, proteins were designed from first principles to have folds in specific locations and surface reactive groups in other places (Krejchi et al. 1994; 1997). One of the target sequences was  $-(\text{AG})_3\text{EG}-_{36}$ . As predicted, the AG regions in these biopolymers formed chain-folded lamellar crystals from the hydrogen-bonded networks of beta sheets and the glutamic acid provided a functional group for surface modification. This illustrates how coupling modeling with design can yield productive nanoscale building blocks.

Self-assembly and template effects are efficient means for generation of complex structures (e.g., helicates,

<sup>1</sup> Roco M.C., in Nanomanufacturing Handbook, A. Busnaina ed., CRC Press, (2007)

<sup>2</sup> Car, R. and Parrinello, M. "Unified approach for molecular dynamics and density functional theory," Phys. Rev. Lett. 55, (1985), p 2471.

<sup>3</sup> Svensson, M. et al., "ONIOM: a multilayered integrated MO + MM method for geometry optimizations and single point energy predictions., J. Phys. Chem., 100, (1996), p 19357

<sup>4</sup> Jelinski, L. in WTEC Report R&D Status and Trends in Nanoparticles, Nanostructured Materials and Nanodevices: "Biological Related Aspects of Nanoparticles, Nanostructured Materials and Nanodevices", (1998) pp113-130

dendrimers, micelles, and mesopores). The challenge is to produce structures with complex function, e.g. domains that can sense an external stimulus, transduce that signal through some internal i.e. conformational change and produce a useful external output signal or product. This requires control of both the lower order assembly pattern, and the higher-order self assembly, which relies on designing and managing a range of noncovalent forces.<sup>5</sup> Biomimetic systems have h-bonding and electrostatic interactions that may collapse as dry scaffolds. Supramolecular assembly relies primarily on electrostatic interactions, while in nanomechanical devices, van der Waals forces and stiction-related phenomena can be of prime importance. The structural and conformational control of function can benefit from the integration of computational quantum chemistry, supra-molecular dynamics simulation, and meso-scale interfaces to macro-scale properties.

Traditionally, computational studies of molecular self-assembly have been performed by Monte Carlo methods, microscopic lattice models, Ginzburg-Landau theories, membrane theories, simple lattice gas models or molecular dynamics (MD) simulations. Lattice gases are a particular kind of cellular automata that allow particles to propagate on the lattice in a natural manner (e.g., Lattice Boltzmann methods). A Molecular Dynamics Lattice Gas technique has been developed for simulation of the assembly of molecular building blocks into complex systems using coarse-grain cellular automata.<sup>6</sup> This hybrid technique accounts for detailed electromagnetic interactions between particles (molecules), and the momentum of the particles is continuous, so thermodynamic phenomena can be studied.

There are a number of reviews which discuss treating multi-scale modeling (atomistic through finite element) through a combination of methodologies.<sup>7</sup> For example, some couple quantum mechanical (QM) calculations within the tight-binding approximation with large-scale molecular dynamics (MD) simulations embedded in a continuum, which is handled with a finite element (FE) approach based on linear elasticity.<sup>8</sup> Similar methods such as Coarse-Grained Molecular Dynamics (CGMD) have been used to study submicron Nano-Electro-Mechanical Systems by

embedding atomistics into a finite element method of continuum mechanics<sup>9</sup>.

Cellular automata can also be used in the design and production of nanosystems. It has been shown that implementing a few simple knowledge-based rules rather than complicated constraints can produce highly complex structures.<sup>10</sup> Using this approach to guide initial fabrication could empower nano-assemblers by relaxing constraints that every placement be rigorously perfect, and precise, in a predefined blueprint pattern to produce functional nanosystems. Traditionally, it is common to work with constraints to force certain behavior to occur. However, by instead using explicit rules to determine how a construction will evolve, even from initial condition that is not perfectly pristine and non-random, one might rapidly produce complex, functional materials. By incorporating a degree of intrinsic randomness a system that may on the small scale be composed of discrete components can be made to exhibit behavior that seems smooth and continuous. Rather than starting from a target pattern that requires complete long-range control of all 2D registration of features during assembly, one can evolve the same degree of controlled growth from an "intelligent" nanoassembler that follows a simple set of rules that depend on it knowing only its immediate surroundings (nearest neighbors). For example, starting from a row of seven cells, a particular cell should be built upon whenever exactly three of its eight neighbors (including diagonals) are occupied, and otherwise it should stay unoccupied. Extension of building into 3D can be accomplished with rules that depend on the 26 neighbors that share a face or corner with a particular cell.

Shown in Figure 1 is a representation of the hierarchical partitioning of different modeling and simulation tools needed for development of rational nanomaterials designed systems.<sup>11</sup>

## Conclusions

A great deal of progress has been made in the development of quantum chemical and molecular simulation modeling tools that are directly applicable to the production of atomically precise nanosystems. In order to maximize their potential, continued progress in integration of these methods more seamlessly through hybrid and coarse grain methods will be important.

<sup>5</sup> Schalley, C.A., Lutzen, A. and Albrecht, M. "Approaching Supramolecular Functionality", *Chem. Eur. J.* (2004), 10, pp 1072-1080.

<sup>6</sup> Nilsson, M., Rasmussen, S. "Cellular Automata for Simulating Molecular Self-Assembly", *Discrete Mathematics and Theoretical Computer Science AB (DMCS)*, (2003), pp 31-42.

<sup>7</sup> Westmoreland P.R. ed. "Applying Molecular and Materials Modeling", WTEC Panel Report (2002),

<sup>8</sup> Abraham, F.F., J.Q. Broughton, N. Bernstein, and E. Kaxiras. 1998. Spanning the length scales in dynamic simulation. *Comput. Phys.* 12, p. 538.

<sup>9</sup> Rudd, R.E. "Concurrent Multiscale Modeling of Embedded Nanomechanics" *MRS Proceedings*, April 2001.

<sup>10</sup> Wolfram, S. "A New Kind of Science", (2002)

<sup>11</sup> Mize, A.S. "Toward Nanomaterials by Design: A Rational Approach for Reaping Benefits in the Short and Long Term" *Foresight Institute*, (2004).

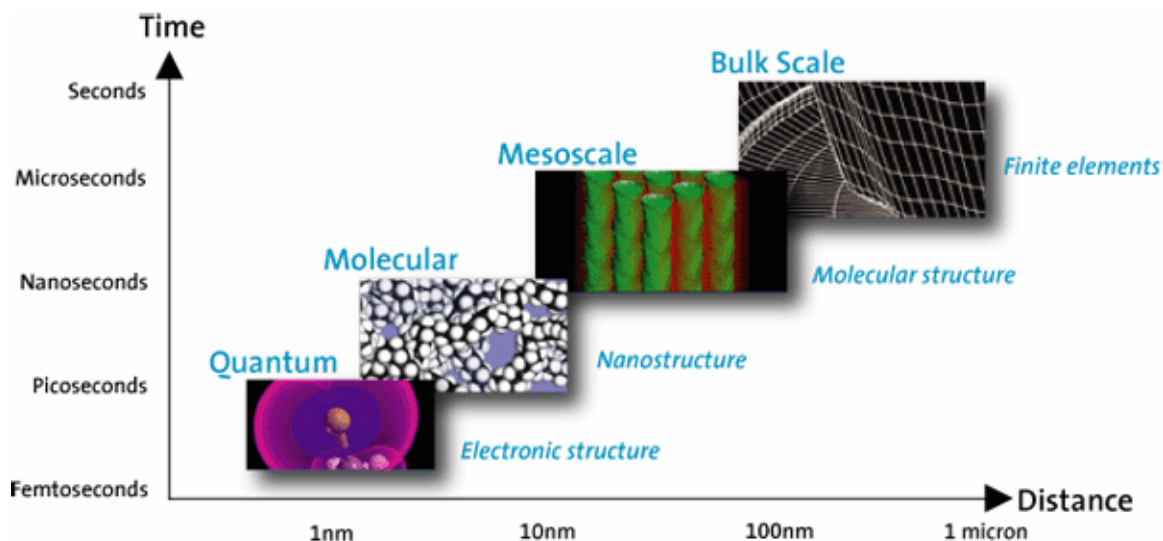

**Figure 1. Hierarchical Integration of Modeling and Simulation Methods (used with permission)<sup>11</sup>**

**Table 1. Molecular Modeling Applications to Atomically Precise Nanosystems**

Approach	Sub-Section	Application to Atomically Precise Nanosystems
Hartree-Fock > 100 atoms	Accounting for multiplicity	HF methods provide the most basic of the fundamentally sound quantum chemical studies one can perform on a molecule
	RHF, UHF, ROHF	As no parameters exist and classes of basis sets do exist that account for most every element in the periodic table, molecular properties can be predicted for nearly all possible molecules
		HF calculations provide sound "approximate geometry" results upon which post-HF methods can be employed in single-point energy calculation methods to property prediction
Density Function Theory	LDA (PWC, VWN)	Ubiquitous application
> 100 atoms	GGA (LYP, P86, B88, BP, BLYP, BOP)	Better property prediction than HF methods, far faster than post-HF methods, which are a LONG ways away from general use due to their computational demand
	Hybrid HF-DFT (B3LYP, B3P86)	Already applicable to solid-state studies, meaning property prediction of extended solids is possible
		Testing, designing new solid-state materials, predicting the properties of designer crystals and finite molecular lattices
	SCC-DFTB	Greater accuracy of deposition processes than HF methods, complete modeling of mechanosynthetic systems is possible
		With fully implemented time-dependent DFT, photophysical studies, dynamical studies, molecular electronics design and simulation becomes possible
		Car-Parrinello molecular dynamics implementations already allow for DFT-MD studies of solids, aggregates, conformational space sampling
Semi-Empirical Methods	GENERAL TYPES	In the absence of MM/MD methods that have parameters for constituent atoms, semi-empirical methods become the route to energy minimization and structural studies



Approach	Sub-Section	Application to Atomically Precise Nanosystems
> 1000 atoms	CNDO, INDO, MNDO, AM1	stepping-stone computational approaches to higher-level calculations, dry-run methodological studies
	PM3, MNDO/d, OM1, OM2, PM5	In the absence of considerable computational resources, semi-empirical methods provide the only route to the study of inorganic solids, given their lack of emphasis in MM/MD
Empirical Methods	Molecular mechanics	rapid prototyping of structural motifs
> 10 <sup>6</sup> atoms	Molecular dynamics	study of thermal stability of non-covalent structures
		with QM/MM implementations, modeling of covalent bond assembly processes
		simulations of transport phenomena in nanofabrication systems
		docking/interaction studies of self-assembling macromolecules, synthetic proteins

## Thoughts on Prospects for New Characterization Tools

### Sample Preparation

One of the key challenges for many imaging characterization methods is in preparing samples. For instance, TEM sample preparation for complex structures or soft materials is currently time consuming and expensive. Improving the throughput and decreasing the cost of key technologies such as focused ion beam (FIB) and cryo-ultramicrotoming sample preparation would aid in accelerating nanoscale research in soft materials, complex structures and at the intersection of biology and nanotechnology.

Sample preparation is a general issue related to nano-materials analysis due to the high surface area, impact of contamination and environmental induced alterations (see below). Increasing the availability of controlled atmosphere sample handling and a general extension of cryogenic sample methods (where appropriate) will enhance the quality of many types of data.

### Scanning Probe Analysis Rate

Currently, scanning probe methods are very much limited by the rate at which the tip can be rastered across a sample. Speeding up the rate of a single tip is only feasible to a point – massively parallel analysis would provide both a significant increase in throughput and sampling robustness.

### In situ/Operando Characterization

Many, if not most, nanoscale characterization methods require the use of ‘artificial’, or at least perturbed environments (vacuum for EM, high purity liquid for DLS, etc). Developing the capability to analyze nanoscale materials under more realistic conditions in real-time is a critical need. Many studies have demonstrated that the physical and chemical characteristics of nanoscale materials may change over time and under varying environments. Providing the capability to image or measure these changes in real time under realistic environments would speed the rate at which new information regarding, for example, the chemical and physical structure of catalytic active sites could be determined.

### Tabletop Synchrotron

The ability to produce and use bright, tunable X-rays in a standard laboratory would be a tremendous advance across many nanoscale materials research applications. The cost of

building and maintaining synchrotron light sources is tremendous, but still considered a good investment given the outstanding research that they enable.

### Data Integration and Automated Analysis

We can do a better job of integrating data from multiple techniques and automating analyses using the best available theoretical understanding of each method. This will require using computational and modeling tools more widely to extract maximum useful information from analyses. Currently, instruments are often used in a ‘routine analysis’ mode, where the information content is limited. For example, in X-ray Photoelectron Spectroscopy analysis of nanoparticles on a surface, the atomic composition, and maybe the chemical state are usually determined and reported. However, it is well-established that modeling of the spectra can also provide information such as contamination (or surface) overlayer thickness, and in some cases, more complex structural information. Fully utilizing this level of understanding in characterization of nanoscale materials would provide researchers additional information for little effort or cost.

Data integration and theoretical modeling is a general issue related to analysis of nanomaterials. Currently analysis often extends concepts and approaches developed for bulk materials to nano-sized materials. As noted by Billinge and Levin in their *Science* review of nano-structure, these concepts do not apply in detail and currently the nano-structure problem has no general solution and a combined experimental and theoretical effort is needed. They also note that no one structural analysis tool will provide adequate information.

### High Spatial Resolution — Not the Only Objective

It must be recognized that there is a critical need to get the high spatial resolution understanding of individual nano-objects AND to develop methods that extract the critical nano-scale information from much larger quantities of materials to determine if they are suitable for some type of manufacturing or assembling process. Integration of these different levels of information and understanding the “distribution” of properties and how they would impact the needed parameters is an important characterization challenge.

## Acknowledgments

Many of the thoughts in this working group proceeding report are based on capabilities and research conducted in the William R. Wiley Environmental Molecular Sciences Laboratory, a national scientific user facility sponsored by

the Department of Energy's Office of Biological and Environmental Research and located at Pacific Northwest National Laboratory, and during work supported by the DOE Office of Science.

## Characterization/Instrumentation Capabilities for Nanostructured Materials

### Background

A strong case can be made that advancements in high resolution imaging tools were a major – if not the major – technology development that enabled the current world wide research focus on nanoscience and nanotechnology. Although the importance of theory, the impact of new computational methods, and the advancement of critical ideas such as supramolecular chemistry and developments in many other areas are all very important, it is difficult to imagine nanotechnology without the ability to see particles and even atoms in almost real time with reasonable cost and widely accessible instrumentation.

The development of high spatial resolution imaging capabilities has played and will continue to play an essential role in the development and advancement of nanoscience and nanotechnology. Techniques to obtain critical information about nano-structured materials include electron microscopy (transmission electron microscopy [TEM] and cryo-electron tomography) and scanning probe microscopy (scanning tunneling microscopy [STM], atomic force microscopy [AFM], and related derivative scanning probes optimized to measure a wide variety of forces). Major research and development efforts are enabling different optical methods (including visible and X-ray) to approach the high spatial resolutions appropriate for measurements in the nanometers scales. A summary of some of these methods is provided in the Nanotechnology Roadmap: Topics in Detail under Design, Modeling, and Characterization.

As should be expected, high spatial resolution methods do not provide all the information needed regarding individual nano-sized objects or collections of them. The need extends beyond high resolution tools to further development and widespread application of other techniques that can provide atomic or molecular level information about nano-structured materials. Almost every available technique has been applied to these materials (see for example Appendix F Tools for characterization of Nanotechnology for the Forest Products Industry—Vision and Technology Roadmap ([http://www.agenda2020.org/PDF/fp\\_nanotechnology.pdf](http://www.agenda2020.org/PDF/fp_nanotechnology.pdf)). The list includes X-ray photoelectron spectroscopy (XPS), X-ray diffraction (XRD), various optical spectroscopies (laser, Raman, IR, light scattering, UV-Vis transmission), second harmonic generation (SHG), sum frequency generation (SFG), and secondary ion mass spectrometry (SIMS). There are two fundamentally different reasons for application of methods without the spatial resolution needed to resolve spatial features of nanoparticles. First current high spatial resolution methods cannot obtain the information needed to fully characterize these particles or there is

significant concern about probe induced alterations in the objects being characterized. Second, for nanotechnology to be truly useful, it is not possible to fully characterize every individual nano-component to verify the needed properties. Methods are needed that provide information about the nature and distribution of properties in a collection of nano-objects. For example, if nanoparticles are to be used in a manufacturing process, it would be desirable to have a probe that provides information about the average property of the nanoparticles provided by a vendor and the distribution and deviation of particles from that average.

The significant advances and major analysis successes are tempered by a growing recognition of significant challenges, many unmet needs, and many opportunities associated with the characterization of nanostructured materials. Several development opportunities were identified in a Report of the National Nanotechnology Initiative 2004 Workshop *Instrumentation and Metrology for Nanotechnology*. A March 2006 article in *Small Times Magazine* (Candace, S., *Small Times Magazine*, 2006) described a workshop held to identify roadblocks to nanobiotech commercialization, and reported the opinion of several experts that many important physical characteristics that are needed to understand the physical and chemical properties of nanoparticles go unreported in research reports or are apparently unmeasured, especially in areas related to assessing particle toxicity. The article also observes that the changes that these particles undergo when exposed to the environment where they are stored or used are especially important and usually unknown. The importance of the surface chemistry of these high surface area materials is sometimes underappreciated (Karakoti, A. S.; Hench, L. L.; Seal, S. *JOM* **2006**, *58*, 77-82) and too often unmeasured.

Determining the three-dimensional atomic structure of nanostructured materials is one specific example of the challenges faced. In a review of the needs and opportunities, Billinge and Levin identify what they call the *nanostructure problem* (Billinge, S. J. L., and Levin, I. *Science* **2007**, *316*, 561-565.). Based upon analysis of different techniques and the nature of the three-dimensional analysis and structure problem, they conclude that currently there are no broadly applicable and robust methods to obtain the needed structural information for nanostructured materials. It is likely that “successful solutions [to the nanostructure problem] will involve interactions among researchers from materials science, physics, chemistry, computer science and applied mathematics working within a “complex modeling” paradigm that combines theory and experiment in a self-consistent computational framework.” They also note that that no single analysis technique yields enough information to enable a unique structural determination. Although

standard structural analysis tools are important and useful for nanostructured materials, they are unable to provide all of the needed structural information.

As indicated by Billinge and Levin in relation to the atomic structure of nano-sized objects, the fundamental physics and chemistry of nano-sized and nano-structured objects play a significant role in their characterization. Different challenges and needs are discussed below.

## Nature of the Desired Nano-Properties

The size for which nano-scale properties significantly alter the behaviors of nano-sized objects depends upon the type of material and the specific property of interest. Some properties (solubility, electron affinity, or quantum-well energy spacing) scale simply with particle size. For these properties it may be important to know particle size within a specific range; some deviation of size may not be significant. However, the chemical properties of metallic clusters (such as Au) alter in an irregular manner as individual atoms of the same element are added to the structure. In this case it is necessary to measure the mass and size of these clusters to the individual atom level.

## Particle Stability, Damage, and Environmental Effects

Because of close lying energy levels, the structure and shape of nano-sized objects can easily be altered by the particle environment and the impact of measurement probes. Nanoparticles have a lower melting point than similar bulk material (highly susceptible to electron and X-ray induced melting) and the structure of nanoparticles can change in response to changes in the environment. In effect, nano-structured materials might be best viewed as “dynamic” objects where the variable nature of the material can actually be an important and useful property. Another important aspect of the variable nature and environmental susceptibility to change is the time dependence and aging properties of the materials. At a 2003 workshop (“National Nanotechnology Coordinating Office Interagency Research Meeting/Workshop – Nanotechnology and the Environment: Applications and Implications”), Robert Hwang observed that it was appropriate to think of nano-materials analysis as a four-dimensional investigation, in which the first two, normally expected for small objects, are expanded by the second two. They are

- (1) spatial resolution (for small objects)
- (2) energy or spectroscopy (for composition and chemical analysis)
- (3) the dimension of time (considering the dynamic and time variation of these materials)

- (4) environment because of the dynamic nature of nano-structured materials.

## Proximity Effects of Separation, Aggregation, and Support Structures

In many different circumstances the properties of individual nano-objects can be altered by supporting these objects on a substrate or placing them in close proximity to other objects. These proximity effects can be viewed as a general environmental influence on particle properties and provide a wide range of possibility for control of the properties of nanostructures, and even enable a “nano-ruler.” From the view point of characterization, it is useful to make measurements in conditions for which either individual or collective properties are of importance.

## Integration of Information from Theory and Different Analysis Methods

As suggested by the *nanotechnology problem* example, in many cases the characterization needed for nanostructured materials will require the integration of information from more than one experimental method and likely the application of theoretical analysis. This need has several aspects. First, a range of complementary analysis methods needs to be available along with the needed expertise. Second, the need to apply many analysis methods stretches the ability of many researchers and students. This reflects the prudence in encouraging collaboration and sharing facilities such as the DOE Nanotechnology User Facilities and the DOE Environmental Molecular Sciences Laboratory. Third, the use of many analysis methods for nano-structured objects could and should include information obtained from other methods. The analysis methods can often be best used if the analysis is *informed* about the nanostructured nature of the material. Unfortunately, this type of analysis approach is currently done only by experts and is not routine. Fourth, there is a great need for additional theory in relation to the properties and characterization of nanostructured objects.

Although advanced analysis tools currently enable a large portion of the research and development effort for nanotechnology worldwide, there are great needs and therefore many opportunities for significant advances in characterization tools. Fundamental prerequisites for further development are

- links between experimental tools and theoretical modeling
- integration of several complementary capabilities
- expert application and use of many techniques
- real-time measurements in “realistic” environments



- consideration of the impacts of probes on the nano-structured systems and materials.

Battelle, through the DOE Nanotechnology User Centers and the EMSL is highly equipped to develop many of these needed advances. As new capabilities are integrated into the Nanocenters and the capital refreshment plan is implemented in EMSL, there will be many opportunities to link theory and analysis and ways to use and integrate complementary information from different analysis methods.

## **Acknowledgments**

Many of the thoughts in this working group proceeding report are based on capabilities and research conducted in the William R. Wiley Environmental Molecular Sciences Laboratory, a national scientific user facility sponsored by the Department of Energy's Office of Biological and Environmental Research and located at Pacific Northwest National Laboratory, and during work supported by the DOE Office of Science.



# Nanomedicine Roadmap: New Technology and Clinical Applications

## Introduction

Nanomedicine is a blending of nanotechnology applied to innovative medical breakthroughs. The National Nanotechnology Initiative (NNI) defines nanotechnology as research and development at the atomic, molecular, or macromolecular levels in the sub-100-nm range (around 0.1 to 100 nm) to create structures, devices, and systems that have novel functional properties. While the term “nanotechnology” refers to a wide range of scientific projects focusing on phenomena or properties of the nanometer scale, nanomedicine concerns itself with the applications of these concepts and tools to clinical and basic medical sciences. We should not use too restrictive a definition of nanotechnology, and that a synergy exists between technology on the nano scale and processes at the micro and macro levels [Ref. 1]. Nanotechnology is already an established discipline, but nanomedicine, with its broad range of ideas, hypotheses, concepts, and undeveloped clinical devices, is still in its early stages. Freitas defines nanomedicine as “the monitoring, repair, construction and control of human biological systems at the molecular level, using engineered nanodevices and nanostructures.” [Ref. 2] Most accounts of the history and origins of nanotechnology begin with Feynman’s 1959 discussion [Ref. 3], in which he outlined the idea of building tiny robots for constructing smaller and smaller machines. This brilliant suggestion did not earn much traction until the mid 1980s, when Drexler [Ref. 4] published “Engines of Creation,” a popular treatment of the promises and potentials of nanotechnology. While a number of nanoassembly processes are in use today, many experts foresee large-scale, full-blown molecular nanotechnology to arrive between 2010 and 2020. Although there are many current nanomedicine technologies in the marketplace, at this stage they concern themselves principally with detection particles, drug delivery systems, emulsions and carriers for delivering vaccines, and nanofabricated biomaterials with unusual properties of strength, hardness, reduced friction, and improved biocompatibility [Ref. 5]. More exotic concepts, such as nanomachines that could move through the body, trouble shooting and repairing tiny brain and cardiovascular lesions, lie in the future.

## Long-Term Goal of Nanomedicine

To move nanomedicine forward, the “NIH Roadmap” has been proposed in order to address the roadblocks and knowledge gaps that currently constrain progress in biomedical research [Ref. 6]. The roadmap will bring together many NIH Institutes and Centers, in order to focus

and consolidate research and development in nanomedicine. NIH Roadmap funding will be allocated for three programs: (1) **New Pathways to Discovery**, a research program to pursue a comprehensive understanding of the body’s cells and tissues and the operation of complex biological systems, using the combined tools of structural biology, molecular libraries, imaging, bioinformatics and computational biology; (2) **Research Teams of the Future**, focusing on interdisciplinary, high-risk research through public-private partnerships; and (3) **Re-engineering the Clinical Research Enterprise**, advancing these discoveries into the clinical sphere.

The Roadmap concepts were developed by NIH in consultation with its professional staff and the public—to identify and prioritize the most pressing problems facing medical research today. The initiatives were selected because of their potential for having the most significant impact on the progress of medical research. Through the NIH Roadmap, NIH aims to accelerate the application of new knowledge to the development of new prevention strategies, diagnostics and treatments, and transfer these into the public domain. Specifically:

- Research centers on nanomedicine will help scientists construct synthetic biological devices, such as miniature, implantable pumps for drug delivery or sensors to scan for the presence of infectious agents or metabolic imbalances that could signify disease.
- Nanomedical approaches will be used to better quantify clinically important symptoms and outcomes, including pain, fatigue, and quality of life that are now difficult to measure. New technologies will be developed to measure these self-reported health states and outcomes across a wide range of illnesses and disease severities.
- A cadre of NIH Clinical Research Associates will be established, composed of community-based practitioners, who will receive specialized training in clinical research. These individuals will aim to advance the discovery process and to disseminate research findings to the community.
- A standardized data system, the National Electronic Clinical Trials and Research (NECTAR) network, will be developed to facilitate the sharing of data and resources, and augment research performance and analysis.

The NIH Roadmap builds on the progress in biomedical research achieved through the recent doubling of the NIH budget. It reflects a shift to adaptive management of the NIH

portfolio, to enable rapid responses to emerging needs and opportunities that do not fit clearly within the mission of the traditional grouping of Institutes and Centers. A unique aspect of the NIH Roadmap is the NIH Director's Pioneer Awards program that will enable highly talented, ingenious scientists to pursue "high risk-high reward" research. The review process for this new grant mechanism will emphasize the creativity and scientific potential of the person, rather than the project, thus providing a new way of supporting individuals who show the most promise for making seminal contributions to medical research.

## Basic Nanomedicine for Cellular and Molecular Dynamics in Living Cells

Over the past few years, fluorescent semiconductor nanocrystals (also known as quantum dots or QDs) have been tested in most biotechnological applications that use fluorescence, including DNA array technology, immunofluorescence assays [Ref. 7], and cell and animal biology. QDs tend to be brighter than dyes because of the compounded effects of extinction coefficients that are an order of magnitude larger than those of most dyes [Refs. 8, 9]. But their main advantage resides in their resistance to bleaching over long periods of time (minutes to hours), allowing the acquisition of images that are crisp and well contrasted. This increased photostability is especially useful for three-dimensional (3D) optical sectioning, where a major issue is bleaching of fluorophores during acquisition of successive *z*-sections, which compromises the correct reconstruction of 3D structures.

In addition, submicrometer studies of cell ultrastructure have been performed with scanning- and transmission-electron microscopes (SEM and STM), and atomic-force microscopes (AFM). However, living cells cannot be examined with the first two instruments because those systems require cell fixation and observation in vacuum, and images of living cells obtained with the AFM may be compromised by direct contact between the cantilever and the sample-deforming soft tissue. High-resolution analysis of activities of live cells is limited by the use of non-invasive methods. It is not practicable to use an apparatus such as SEM, STM, or AFM because the necessary treatment or the harsh contact with system probe will disturb or destroy the cell. Optical methods are purely non-invasive, but they are usually diffraction limited, and their resolution is limited to approximately 1  $\mu\text{m}$ . To overcome these restrictions, the study of membrane activity of a live cell sample using a Scanning Near-field Optical Microscope (SNOM) is developed [Refs. 10-13]. A near-field optical microscope is able to detect tiny vertical movement on the cell membrane in the range of only 1 nm or less, about 3 orders of magnitude better than conventional optical microscopes. It is a purely non-invasive, non-contact method, so the natural life activity of the sample is unperturbed. This methodology

will open a new approach to investigate live samples. The extreme sensitivity of SNOM and specialized QDs allows measurements that are not possible with any other method on live biomaterial paving the way for a broad range of novel studies and applications.

## Clinical Nanomedicine for Future Therapeutics Approach

The three main areas of nanotherapeutics under study and development at the Institute are drug therapy, gene therapy and immunotherapy. In drug therapy, nanotechnology can dramatically improve the therapeutic potential of many water-insoluble and unstable drugs either through size reduction or encapsulation of the drug particles. In gene therapy, polymers and lipids can condense DNA into nanoparticles that can be internalized by cells, followed by delivery of the DNA into the nucleus. DNA-nanoparticles can deliver functional genes to correct genetic disorders such as hemophilia, cystic fibrosis, and muscular dystrophy. In addition, lipid-based nanosystems such as nanoemulsions, lipid-core micelles, small unilamellar vesicles, and variations thereof, have long been in existence and some have long been improving patient's lives. Indeed, lipid-based nanoformulations are among the most attractive candidates for improving drug solubility and for site-specific targeting following parenteral administration. Specifically, great strides are being made with such complexes and nanosystems in combating the growth and spread of cancerous tissues (e.g., through exploitation of angiogenic tumour vasculature, combination chemotherapy, and endogenous triggered activation and release of encapsulated lipid prodrugs), treatment of macrophage infections (through exploitation of macrophage clearance mechanisms), gene transfer (by breaching the endo-lysosomal barrier with cationic lipid vectors) and stimulation of immune responses to antigens (with the aid of vesicular systems and lipid-complexes with self-adjuvanting properties). Although, lipid-based nanocarriers may overcome solubility or stability issues for the drug and minimize drug-induced side effects through favorable pharmacokinetic profiles and site-specific targeting, there are significant toxicity issues with carriers themselves that need to be addressed. However, nanotechnology in therapeutics has provided a broad sample of the state of the art.

## Engineering Nanomedicine to Develop Nano-Devices, -Biosensors, -Tubes, -Wires, and NEMS

Nanomaterials are exquisitely sensitive chemical and biological sensors. Nanosensors with immobilized bioreceptor probes that are selective for target analyte molecules are called nanobiosensors. They can be integrated into other technologies such as lab-on-a-chip to facilitate

molecular diagnostics. Their applications include detection of microorganisms in various samples, monitoring of metabolites in body fluids and detection of tissue pathology such as cancer. The nanomaterials transduce the chemical binding event on their surface into a change in conductance of the nanowire in an extremely sensitive, real time and quantitative fashion. Boron-doped silicon nanowires (SiNWs) have been used to create highly sensitive, real-time electrically based sensors for biological and chemical species [Ref. 14]. The small size and capability of these semiconductor nanowires for sensitive, label-free, real-time detection of a wide range of chemical and biological species could be exploited in array-based screening and in vivo diagnostics.

Nanowires and nanotubes carry charge and excitons efficiently, and are therefore potentially ideal building blocks for nanoscale electronics and optoelectronics [Refs. 15, 16]. Carbon nanotubes have already been exploited in devices such as field-effect [Refs. 17, 18] and single electron [Refs. 19, 20] transistors, but the practical utility of nanotube components for building electronic circuits is limited, as it is not yet possible to selectively grow semiconducting or metallic nanotubes [Refs. 21, 22]. The electrical properties of the assembly of functional nanoscale devices are controlled by selective doping.

## Diagnostic Nanomedicine for Cellular and Organ Imaging

Nanomolecular diagnostics is the use of nanobiotechnology in molecular diagnostics [Refs. 23, 24]. Nanotechnology is the creation and utilization of materials, devices, and systems through the control of matter on the scale length of a nanometer (1 billionth of a meter). Numerous nanodevices and nanosystems for sequencing single molecules of DNA are feasible. Given the inherent nanoscale of receptors, pores, and other functional components of living cells, the detailed monitoring and analysis of these components will be made possible by the development of a new class of nanoscale probes. Nanobiotechnologies are clinically relevant and have the potential to be incorporated in clinical laboratory diagnosis. Nanotechnologies enable the diagnosis at single cell and molecule level and some of these can be incorporated in the current molecular diagnostics such as biochips. Besides following techniques, nanoparticles, such as gold nanoparticles and quantum dots, are the most widely used. The nanotechnology-based chips on a nanoscale are related to nanomanipulation. The droplets used are 1 billion times smaller in volume than has been demonstrated by conventional methods. The levitated particles can be manipulated and positioned with accuracy within a range up to 300 nm. Use of this technology on a lab-on-a-chip would refine the examination of fluid droplets containing trace chemicals and viruses. As such, these technologies will

extend the limits of current molecular diagnostics and enable point-of-care diagnosis as well as the development of personalized medicine. Although the potential diagnostic applications are unlimited, most important current applications are foreseen in the areas of biomarker research, cancer diagnosis and detection of infectious microorganisms.

## Genetic Nanomedicine for Gene Detection and Gene Delivery

Gene delivery is an area of considerable current interest; genetic materials (DNA, RNA, and oligonucleotides) have been used as molecular medicine and are delivered to specific cell types to either inhibit some undesirable gene expression or express therapeutic proteins. To date, the majority of gene therapy systems are based on viral vectors delivered by injection to the sites where the therapeutic effect is desired. Viral gene-transfer techniques can deliver a specific gene to the nucleus of a cell, for expression, through integration into the genome or as episomal vectors. Viral vectors can have potentially dangerous side effects due to unintended integration of the viral DNA into the host genome, which may include incorporation of the virus into the hosts immune system and, hence, have been less successful than originally hoped. Liposome based gene transfer has relatively low transfection rates, are difficult to produce in a specific size range, can be unstable in the blood stream, and are difficult to target to specific tissues [Ref. 25]. Injection of naked DNA, RNA, and modified RNA directly into the blood stream leads to clearance of the injected nucleic acids with minimal beneficial outcome [Ref. 26].

The use of non-viral vectors represents a good alternative to viral vectors because of their non-immunogenicity and easy production; however, most non-viral vectors have lacked the high transfection efficiency obtained with viral vectors. As such, there is currently a need for a gene delivery system that has minimal side effects but high potency and efficiency. The idea that nanosystems have unique physical and biological properties that might be used to overcome the problems of gene and drug delivery has gained interest in recent years. Nanosystems can be designed with different compositions and biological properties. Some of these systems, such as nanoparticles, dendrimers, nanocages, micelles, molecular conjugates, liposomes and so on, have been extensively investigated for drug and gene delivery applications [Ref. 27]. One such system could be that of the self-assembled nanoparticles coated with targeting biomolecules [Ref. 28]. It uses a nanoparticle platform for diagnostic probes and effective targeted therapy [Ref. 29].

## Nanotechnology-Based Regenerative Medicine: Cell Sheet Engineering

By combining preformed biodegradable polymer scaffolds and specific cell types, various tissues including



cartilage, bone, and blood vessels have been reconstructed, although, so far, therapeutic use has been very limited. A method to circumvent the need for the traditional technology is “cell sheet engineering” which utilizes temperature-responsive culture surfaces. These novel surfaces are created by the covalent grafting of the temperature-responsive polymer, poly(*N*-isopropylacrylamide) by electron beam irradiation. The grafted polymer thickness and density are precisely regulated in a nanometer regime. These surfaces allow for the non-invasive harvest of cells by simple temperature reduction. Confluent cells are non-invasively harvested as single, contiguous cell sheets with intact cell-cell junctions and deposited extracellular matrix from the surfaces. These harvested cell sheets have been used for various tissue reconstructions, including ocular surfaces [Ref. 30], periodontal ligaments, cardiac patches [Refs. 31, 32], esophagus, liver [Ref. 33], and various other tissues.

## Oncology Nanomedicine for Early Cancer Diagnosis and Treatment

Targeting and local delivery are the key challenges in both diagnosis and treatment of cancer. Cancer therapies are based on a better understanding of the disease at the molecular level. Nanobiotechnology is being used to refine discovery of biomarkers, molecular diagnostics, drug discovery and drug delivery, which are important basic components of personalized medicine and are applicable to management of cancer as well. Examples are given of the application of quantum dots, gold nanoparticles, and molecular imaging in diagnostics and in combination with therapeutics—another important feature of personalized medicine. Management of cancer, facilitated by nanobiotechnology, is expected to enable early detection of cancer, more effective and less toxic treatment increasing the chances of cure.

Nanotechnology is an emerging interdisciplinary field dedicated to the manipulations of atoms and molecules that lead to the construction of structures in the nanometer scale size range that retain unique properties. Emerging BioMicroNano-technologies have the potential to provide accurate, real-time, high-throughput screening of tumor cells without the need for time-consuming sample preparation. These rapid, nano-optical techniques may play an important role in advancing early detection, diagnosis, and treatment of disease. Recently, many nanotechnology tools have become available which can make it possible for clinicians to detect tumors at an early stage. The nanostructures can potentially enter the single tumor cell, which can help improve the current detection limit by imaging techniques. Gourley [Ref. 34] shows that laser scanning confocal microscopy can be used to identify a previously unknown property of certain cancer cells that distinguishes them, with single-cell resolution, from closely related normal cells. This property is the correlation of light scattering and the spatial

organization of mitochondria. In addition, the new technology of nanolaser spectroscopy using the biocavity laser can be used to characterize the unique spectral signatures of normal and transformed cells. These optical methods represent powerful new tools that hold promise for detecting cancer at an early stage and may help to limit delays in diagnosis and treatment. Nanotechnology can help diagnose cancer using dendrimers and kill tumor cells without harming normal healthy cells by tumor selective delivery of genes using nanovectors. These and other technologies currently are in various stages of discovery and development.

## Pharmacological Nanomedicine for Drug Delivery and Drug Design

The application of nanotechnology in life sciences is becoming a hot topic in drug design and drug delivery. The nanotechnologies, including nanoparticles and nanodevices such as nanobiosensors and nanobiochips, are used to improve drug discovery and development. Nanoscale assays can contribute significantly to cost-saving in screening campaigns. Many drugs discovered in the past could not be used in patients because a suitable method of drug delivery was lacking. Nanotechnology is also used to facilitate drug delivery. A product incorporating the NanoCrystal technology of Elan Drug Delivery (King of Prussia, PA, USA), a solid-dose formulation of the immunosuppressant sirolimus, was approved by the FDA in 2000 [Ref. 35]. Abraxane™ (Abraxis™ Oncology), containing paclitaxel as albumin-bound particles in an injectable suspension, is approved for the treatment of breast cancer after the failure of combination chemotherapy for metastatic disease or after relapse within six months of adjuvant chemotherapy. It is based on nanoparticle technology, which integrates biocompatible proteins with drugs to create the nanoparticle form of the drug (with a size  $\sim$ 100 to 200 nm) to overcome the insolubility problems encountered with paclitaxel. Now, the trend is to consider drug-delivery issues at the earlier stages of drug discovery and design. Potential applications of nanotechnology to facilitate drug delivery can be taken into consideration at the stage of drug design. A carrier nanoparticle can be designed simultaneously with the therapeutic molecule. Although there might be some safety concerns with respect to the *in vivo* use of nanoparticles, studies are in place to determine the nature and extent of adverse events. Future prospects for the application of nanotechnology in healthcare and for the development of personalized medicine appear to be excellent.

## Dendrimer Based Nanomedicine: Its Impact on Biology, Pharma Delivery, and Polyvalent/Targeted Therapies

Dendrimers are now referred to as “artificial proteins” based on the close scaling/mimicry of their dimensions, shapes and surface chemistries to these biological nanostructures [Refs. 36-38]. Considering the importance of nanoscale structures, dimensions associated with proteins, DNA, antibody-antigen complexes, viral particles, to mention a few, it is safe to make the following statement: *“The positive management of human health, disease and longevity will likely be determined/controlled by a deeper understanding of critical parameters in the nano-length scale; namely: nanomedicine.”* This theme will be used to present the use of precise, synthetic nanostructures (i.e., dendrimers) as critical nanoscale building blocks in a variety of nano-diagnostic, drug delivery and nano-pharma-type applications [Refs. 39, 40].

Dendrimers are routinely synthesized as tunable nanostructures that may be designed and regulated as a function of their size, shape, surface chemistry, and interior void space. They are obtained with structural control approaching that of traditional biomacromolecules such as DNA/RNA or proteins and are distinguished by their precise nanoscale scaffolding and nanocontainer properties. These important properties are expected to play an important role in the emerging field of nanomedicine. Recent efforts have focused on the synthesis and preclinical evaluation of multipurpose dendrimer prototype STARBURST PAMAM (polyamidoamine) that exhibits properties suitable for use as: (i) targeted, diagnostic MRI/NIR (near-IR) contrast agents, (ii) and/or for controlled delivery of cancer therapies. This dendritic nanostructure (~5.0 nm in diameter) was selected on the basis of a very favorable biocompatibility profile, the expectation that it will exhibit desirable mammalian kidney excretion properties and demonstrated targeting features.

## Cardiovascular Nanomedicine for Heart and Vascular Diseases

Cardiovascular disease remains the leading cause of death in the United States. One out of every four Americans has cardiovascular disease and every 30 seconds one person dies from heart disease. Although significant advances have been made in the management and treatment of this disease, the effectiveness of early detection and treatment in preventing heart attacks is still questionable, since few of the heart attacks could be predicted by the physicians. One of the fundamental and unresolved problems in cardiovascular biology is the in vivo detection of atherosclerotic disease and the evaluation of atherosclerotic disease activity. Current technology limits clinicians to diagnostic techniques that

either image or functionally assess the significance of large obstructive vascular lesions. Techniques have been developed recently to achieve molecular and cellular imaging with most imaging modalities, including nuclear, optical, ultrasound, and magnetic resonance imaging (MRI). In addition, current imaging modalities do not allow for the possibility of imaging atherosclerotic disease at its earliest stages nor do available techniques allow routine assessment of atherosclerotic lesions susceptible to rupture and/or thrombosis. This is of particular clinical significance given that myocardial infarctions and other sequela of atherosclerotic disease are just as likely to occur from small non-obstructive coronary artery disease based on the degree of luminal obstruction is fundamentally flawed. Newer technologies must be developed that are capable of identifying earlier atherosclerotic lesions as well as atherosclerotic lesions that are active or unstable. The role of nanotechnology in cardiovascular diagnosis is expanding rapidly. It has been applied to the area of atherosclerosis, thrombosis, and vascular biology. The technologies for producing targeted nanosystems are multifarious and reflect end uses in many cases. The results to date indicate rapid growth of interest and capability in the field. The future of cardiovascular diagnosis is already being impacted by nanosystems that can be both diagnose pathology and treat it with targeted delivery systems. To date, both advanced imaging methods and new targeted nanoparticles contrast agents for early characterization of atherosclerosis and cardiovascular pathology at the cellular and molecular levels that might represent the next frontier for combining imaging and rational drug delivery to facilitate personalized medicine. The rapid growth of nanotechnology and nanoscience could greatly expand the clinical opportunities for molecular imaging.

## Neurological Nanomedicine for Neuroscience Research

Applications of nanotechnology in basic neuroscience include those that investigate molecular, cellular and physiological processes. They fall in three specific areas. The first is nanoengineered materials and approaches for promoting neuronal adhesion and growth to understand the underlying neurobiology of these processes or to support other technologies designed to interact with neurons in vivo (for example, coating of recording or stimulating electrodes) [Ref. 41]. The second is nanoengineered materials and approaches for directly interacting, recording and/or stimulating neurons at a molecular level [Ref. 42]. The third is imaging applications using nanotechnology tools, in particular, those that focus on chemically functionalized semiconductor quantum dots [Ref. 43]. Applications of nanotechnology in clinical neuroscience include research aimed at limiting and reversing neuropathological disease states. Nanotechnology approaches are designed to support and/or promote the functional regeneration of the nervous

system [Ref. 44]; neuroprotective strategies, in particular those that use fullerene derivatives [Ref. 45]; and nanotechnology approaches that facilitate the delivery of drugs and small molecules across the blood-brain barrier (BBB) [Ref. 46]. Applications of nanotechnologies for neuroprotection have focused on limiting the damaging effects of free radicals generated after injury, which is a key neuropathological process that contributes to CNS ischaemia, trauma and degenerative disorders [Ref. 47].

## **Dermatological Nanomedicine for Skin Research**

There are several nanoparticles used in molecular imaging: gold nanoparticles, quantum dots and magnetic nanoparticles. Gold nanoparticles are particularly good labels for sensors because a variety of analytical techniques can be used to detect them, including optical absorption, fluorescence, Raman scattering, atomic and magnetic force, and electrical conductivity. This technique can be used to detect microorganisms and could replace PCR and fluorescent tags used currently. Quantum dots (QDs) are nanoscale crystals of semiconductor material that glow, or fluoresce when excited by a light source such as a laser. QDs have fairly broad excitation spectra—from ultraviolet to red—that can be tuned depending on their size and composition. At the same time, QDs have narrow emission spectra, making it possible to resolve the emissions of different nanoparticles simultaneously and with minimal overlap. QDs are highly resistant to degradation, and their fluorescence is remarkably stable. Bound to a suitable antibody, magnetic nanoparticles are used to label specific molecules, structures, or microorganisms. Magnetic immunoassay techniques have been developed in which the magnetic field generated by the magnetically labeled targets is detected directly with a sensitive magnetometer.

## **Nanotoxicology in Health and the Environment Research**

It is still very early in the toxicological evaluation and characterization of the safety of nanomaterials, and there are few data on the safety of nanomaterials at the present time. There is no question that this situation is rapidly changing. There is also little debate over the fact that even though it is recognized that nanomaterials exhibit unique properties that clearly distinguish them from their bulk counterparts, many of the methods, tests, assays, and principles that have been the cornerstones of traditional approaches to safety assessment can also be applied to the design of the studies characterizing nanomaterial safety. There is a good foundation on how to proceed with characterizing the safety of nanomaterials that has been developed through several years of studying materials such as fine and ultrafine particles, increasing understanding of the lungs and the skin

as portals of entry and as potential target organs, and improving approaches to characterize the important roles played by absorption, distribution, metabolism, and excretion. It is generally thought that it is unlikely that nanomaterials will manifest new toxic manifestations in spite of their unique physical-chemical properties. Therefore, many traditional methods and approaches will likely be applicable to studies of nanomaterials, especially if it is acknowledged that not all nanoscale materials are the same and that potential impacts due to the unique properties of these materials are to be expected.

## **Conclusion and Future Development of Nanomedicine**

Nanotechnology is beginning to change the scale and methods of vascular imaging and drug delivery. Indeed, the NIH Roadmap's 'Nanomedicine Initiatives' envisage that nanoscale technologies will begin yielding more medical benefits within the next 10 years. This includes the development of nanoscale laboratory-based diagnostic and drug discovery platform devices such as nanoscale cantilevers for chemical force microscopes, microchip devices, and nanopore sequencing, to note a few. The National Cancer Institute has related programs too, with the goal of producing nanometer scale multifunctional entities that can diagnose, deliver therapeutic agents, and monitor cancer treatment progress. These include design and engineering of targeted contrast agents that improve the resolution of cancer cells to the single cell level, and nanodevices capable of addressing the biological and evolutionary diversity of the multiple cancer cells that make up a tumor within an individual. Thus, for the full in vivo potential of nanotechnology in targeted imaging and drug delivery to be realized, nanocarriers have to get smarter. Pertinent to realizing this promise is a clear understanding of both physicochemical and physiological processes. These form the basis of complex interactions inherent to the fingerprint of a nanovehicle and its microenvironment. Examples include carrier stability, extracellular and intracellular drug release rates in different pathologies, interaction with biological milieu, such as opsonization, and other barriers en route to the target site, be it anatomical, physiological, immunological or biochemical, and exploitation of opportunities offered by disease states (e.g., tissue-specific receptor expression and escape routes from the vasculature). Inherently, carrier design and targeting strategies may vary in relation to the type, developmental stage, and location of the disease. Toxicity issues are of particular concern but are often ignored. Therefore, it is essential that fundamental research be carried out to address these issues if successful efficient application of these technologies is going to be achieved. The future of nanomedicine will depend on rational design of nanotechnology materials and tools based around a detailed and thorough understanding of biological processes rather

than forcing applications for some materials currently in vogue.

## References

1. Putnam D. Polymers for gene delivery across length scales. *Nat Mater.* 2006;5:439-451.
2. Freitas RA. What is nanomedicine? *Nanomedicine* 1:2-9, 2005.
3. Hush NS. An overview of the first half-century of molecular electronics. *Ann N Y Acad Sci.* 1006:1-20; 2003.
4. Drexler KE. Molecular engineering: An approach to the development of general capabilities for molecular manipulation. *Proc Natl Acad Sci USA* 1981; 78: 5275-6278.
5. Haynie DT, Zhang L, Zhao W, Rudra JS. Protein-inspired multilayer nanofilms: science, technology and medicine. *Nanomedicine.* 2006;2:150-157.
6. Westfall JM, Mold J, Fagnan L. Practice-based research--"Blue Highways" on the NIH roadmap. *JAMA.* 2007;297:403-6.
7. A. P. Alivisatos, *Nature Biotechnol.* 22, 47 (2004).
8. B. Dubertret et al., *Science* **298**, 1759 (2002).
9. B. Ballou, B. C. Lagerholm, L. A. Ernst, M. P. Bruchez, A. S. Waggoner, *Bioconjug. Chem.* **15**, 79 (2004).
10. Rosaria Piga, Ruggero Micheletto and Yoichi Kawakami. Nano-probing of the membrane dynamics of rat pheochromocytoma by near-field optics. *Biophys Chem.* 117 (2005), pp 141-146.
11. S.M. Moghimi *et al.*, Long-circulating and target-specific nanoparticles: theory to practice. *Pharmacol. Rev.* **53** (2001), pp. 283–318.
12. A.C. Hunter and S.M. Moghimi, Therapeutic synthetic polymers: a game of Russian roulette?. *Drug Discov. Today* **7** (2002), pp. 998–1001.
13. J.D. Hood *et al.*, Tumor regression by targeted gene delivery to the neovasculature. *Science* **296** (2002), pp. 2404–2407.
14. Y. Cui, Q. Wei, H. Park and C.M. Lieber, Nanowire nanosensors for highly sensitive and selective detection of biological and chemical species, *Science* **293** (2001), pp. 1289–1292.
15. Hu, J., Odom, T.W. & Lieber, C.M. Chemistry and physics in one dimension: synthesis and properties of nanowires and nanotubes. *Acc. Chem. Res.* 32, 435-445 (1999).
16. Dekker, C. Carbon nanotubes as molecular quantum wires. *Phys. Today* 52(5), 22-28 (1999).
17. Tans, S. J., Verschueren, R. M. & Dekker, C. Room temperature transistor based on a single carbon nanotube. *Nature* 393, 49-52 (1998).
18. Martel, R., Schmidt, T., Shea, H. R., Hertel, T. & Avouris, P. Single- and multi-wall carbon nanotube @eld effect transistors. *Appl. Phys. Lett.* 73, 2447-2449 (1998).
19. Tans, S. J. et al. Individual single-wall carbon nanotubes as quantum wires. *Nature* 386, 474-477 (1997).
20. Bockrath, M. et al. Single electron transport in ropes of carbon nanotubes. *Science* 275, 1922-1925 (1997).
21. Odom, T. W., Huang, J.-L., Kim, P. & Lieber, C. M. Atomic structure and electronic properties of single-walled carbon nanotubes. *Nature* 391, 62-64 (1998).
22. Wildoer, J. W. G., Venema, L. C., Rinzler, A. G., Smalley, R. E. & Dekker, C. Electronic structure of atomically resolved carbon nanotubes. *Nature* 391, 59-62 (1998).
23. K. K. Jain, Nanotechnology in clinical laboratory diagnostics, *Clinica Chimica Acta* 358 (2005), pp. 37-54.
24. Nishida K, Yamato M, Hayashida Y, et al. Corneal reconstruction with tissue-engineered cell sheets composed of autologous oral mucosal epithelium. *N Engl J Med.* 2004;351:1187-1196.
25. K.K. Jain, Nanodiagnostics: application of nanotechnology in molecular diagnostics, *Expert Rev Mol Diagn* 3 (2003), pp. 153–161.
26. De Smedt SC et al 2000. Cationic polymer based gene delivery systems. *Pharm Res.* 17: 113-126.
27. Sandberg JA et al 2000. *Antisense nucleic A* 10: 153-162.
28. Sahoo SK, Labhassetwar V: Nanotech approaches to drug delivery and imaging. *Drug Discov Today.* 2003, 8: 1112-1120.
29. Lvov Y and Caruso F 2001. Biocolloids with ordered urease multilayer shells as enzymatic reactors. *Anal Chem* 73: 4212-4217.
30. Sumide T, Nishida K, Yamato M, et al. Functional human corneal endothelial cell sheets harvested from temperature-responsive culture surfaces. *FASEB J.* 2006;20:392-394.
31. Shimizu T, Sekine H, Yang J, et al. Polysurgery of cell sheet grafts overcomes diffusion limits to produce thick, vascularized myocardial tissues. *FASEB J.* 2006;20:708-710.
32. Ohki T, Yamato M, Murakami D, et al. Treatment of oesophageal ulcerations using endoscopic transplantation of tissue-engineered autologous oral mucosal epithelial cell sheets in a canine model. *Gut.*2006;55:1704-1710.
33. Ohashi K, Yokoyama T, Yamato M, et al. Engineering functional two- and three-dimensional liver systems in vivo using hepatic tissue sheets. *Nat Med.* 2007;13:880-885.
34. Gourley PL, Hendricks JK, McDonald AE, Copeland RG, Barrett KE, Gourley CR, Singh KK, and Naviaux RK. Mitochondrial correlation microscopy and nanolaser spectroscopy - new tools for biophotonic detection of cancer in single cells. *Technol Cancer Res Treat.* (2005) 4 (6):585-92.
35. K. K. Jain. 2005 The role of nanotechnology in drug discovery. *Drug Discovery Today.* 10 (21): 1435-1442.



36. Svenson S, Tomalia DA. Dendrimers in biomedical applications--reflections on the field. *Adv Drug Deliv Rev.* 2005
37. Tomalia DA, Reyna LA, Svenson S. Dendrimers as multi-purpose nanodevices for oncology drug delivery and diagnostic imaging. *Biochem Soc Trans.* 2007;35:61-7.
38. Tomalia DA. Supramolecular chemistry: fluorine makes a difference. *Nat Mater.* 2003;2:711-2.
39. Svenson S, Tomalia DA. Dendrimers in biomedical applications—reflections on the field. *Adv Drug Deliv Rev.* 2005 Dec 14;57(15):2106-29.
40. Tomalia DA, Reyna LA, Svenson S. Dendrimers as multi-purpose nanodevices for oncology drug delivery and diagnostic imaging. *Biochem Soc Trans.* 2007;35(1):61-7.
41. Moxon, K. A. *et al.* Nanostructured surface modification of ceramic-based microelectrodes to enhance biocompatibility for a direct brain-machine interface. *IEEE Trans. Biomed. Eng.* 51, 881–889 (2004).
42. Vu, T. Q. *et al.* Activation of membrane receptors by a neurotransmitter conjugate designed for surface attachment. *Biomaterials* 26, 1895–1903 (2005).
43. Dahan, M. *et al.* Diffusion dynamics of glycine receptors revealed by single-quantum dot tracking. *Science* 302, 442–445 (2003).
44. Silva, G. A. *et al.* Selective differentiation of neural progenitor cells by high-epitope density nanofibers. *Science* 303, 1352–1355 (2004).
45. Dugan, L. L. *et al.* Fullerene-based antioxidants and neurodegenerative disorders. 7, 243–246 (2001).
46. Gelperina, S. E. *et al.* Toxicological studies of doxorubicin bound to polysorbate 80-coated poly(butyl cyanoacrylate) nanoparticles in healthy rats and rats with intracranial glioblastoma. *Toxicol. Lett.* 126, 131–141 (2002).
47. Lo, E. H., Dalkara, T. & Moskowitz, M. A. Mechanisms, challenges and opportunities in stroke. *Nature Rev. Neurosci.* 4, 399–415 (2003).



## Applications for Positionally Controlled Atomically Precise Manufacturing Capability

This supplemental report outlines potential near-term target applications for systems with limited capabilities to fabricate atomically precise objects via positional control. Positional control may be achieved in several different ways, thus, this analysis makes no assumptions about how the positional control is accomplished, except where noted. By “limited capabilities,” we mean:

- Little or no parallelization, limiting the number of objects that can be fabricated per unit time. This also puts realistic limits on the size of the objects—perhaps a few hundred to a few thousand atoms as a practical upper limit, depending on the degree of automation available.
- Only a few types of atoms (<5) can be used as building blocks. This implies that the tool tip set is limited as well, and can position and react with only a few types of molecules.

Nanostructures fabricated via positional control would have qualitatively different characteristics from nanostructures fabricated by self-assembly, so this section focuses only on applications that take advantage of positionally controlled processes. Greater design complexity is possible at the atomic level with positional control, but the tradeoff is that the scale-up to larger systems is more difficult. In fabrication by self-assembly, scale-up is readily accomplished because the individual building block units naturally link to each other. In a positionally controlled system, scale-up of product size would be dependent on parallelization of the fabrication devices or increasing their speed of operation.

A hybrid approach might involve designing the positionally controlled structures as self-assembling subunits that can spontaneously interlock, but are mechanically guided or designed to form structures of significantly greater complexity than if the subunits simply coalesce out of solution. The difference would be analogous to Lego® blocks being randomly assembled vs. crafted into clever designs [Ref. 1].

### Atomic Precision Matters

DARPA has recently issued a Broad Agency Announcement (BAA) soliciting proposals on Tip-Based Nanofabrication to make nanowires, nanotubes, or quantum dots using functionalized scanning probe tips [Ref. 2]. Clearly, these applications are of particular importance and worthy of mention in this section of the Roadmap. We note, however, that the BAA does not specify sufficient positional resolution to accomplish atomically precise manufacturing (Table 1). This difference in precision is important.

The ability to fabricate nanodevices to atomic precision promises order-of-magnitude improvements in the performance of materials and devices—even compared with devices fabricated to nanometer precision. For example:

- Fluids pass through an array of multi-wall carbon nanotubes at velocities 1000 to 100,000 times greater than would be expected from continuum mechanics [Ref. 3]. This is because nanotube walls are essentially atomically perfect, and that fundamentally changes the nature of the interaction between the fluid molecules and tube walls compared with normal microscopically rough tubes.

**Table 1. Metrics in DARPA BAA for Tip-Based Nanomanufacturing [Ref. 2].**

Metric	Unit	Phase I	Phase II	Phase III
Feature Position Control	nm	50	25	5
Feature Size Control	% of dimension	10%	3%	1%
Heterogeneity		2 values of one parameter	5 values of 2 parameters	Continuous control over 2 parameters
Feature Rate		1/min Single tip	5/min/tip 5-tip array	60/min/tip 30-tip array
Tip Shape Variation	% of dimension	Height<10% Radius<20% 100 operations	Height<10% Radius<20% 10 <sup>3</sup> operations	Height<10% Radius<20% 10 <sup>6</sup> operations
Tip Height Sensing	nm	20 nm	10 nm	2 nm

- A small change in precision can have significant consequences: the affinity of the molecule *histamine-SGA* for a receptor site was changed by a factor of 14,500 by making a sub-nanometer change in geometry to the receptor site surface (replacing a CH<sub>3</sub> group with H) [Ref. 4].
- In a theoretical analysis of diamond-like sleeve bearings, changing the circumference of the inner sleeve by a single carbon atom (only a few Angstroms) increased the energy barrier to rotation<sup>1</sup> ten million times [Ref. 5].

Because this difference is critical, we focus on specific advantages of atomic precision for each application. For positional assembly, the pathway to achieving this is in the reverse order of that shown in Table 1, which progresses toward increasingly greater precision. By contrast, the evolution of positionally controlled APM starts from our current capability to position a single atom on a surface, and progresses to larger and larger atomically precise structures as the technology matures.

## Applications

### *High Quality Contacts for Molecular Electronic Devices*

An important problem in the development of molecular electronic devices is establishing a consistent electrical connection between molecular wires and molecular switches [Ref. 6, 7]. Ideally, this requires an atomically precise interface between the two components for an optimal conductive path, but current technological capabilities limit our ability to provide this consistently. In the near term, if we could use a limited APM system to construct a defect-free interconnect, this would allow us to interface with an individual molecular switch in an optimal manner, and measure its performance more accurately. With parallelization or fast automation (such as proposed for NIST's Autonomous Atom Assembly system [Ref. 8]), many molecular electronic devices could be integrated into an array of high reliability, which could then be interfaced with microelectronic systems.

### *Highly Stable Single Electron Transistor (SET) Devices*

Because they are one of the most sensitive devices for measuring electric charge, and because they can transfer individual electrons, SETs have been proposed as components for nanoelectronic systems. Single electron

transistor device sensitivity is limited by low frequency noise [Ref. 9], and these devices are also subject to drift of the correct operating gate voltage [Ref. 10]. Both of these difficulties are caused by atomic defects in the metal or semiconductor that migrate over time. These defects, or vacancies, in the crystal lattice are artifacts of today's manufacturing processes which cannot reduce vacancy concentrations below a thermodynamic equilibrium level. With the ability to construct crystals with every atom in position, APM provides a method to produce metals with metastable vacancy concentrations near zero, and to maintain this condition by sealing the surfaces with ionically or covalently-bound films. Therefore, SETs could be manufactured that perform near their theoretical limits for highly reliable operation at maximum sensitivity.

### *Quantum Computing*

Quantum computers, once developed with capacities larger than a few qubits, may be able to significantly outperform classical computers for certain problems such as simulations of quantum mechanics and factoring large integers (useful for "cracking" many types of encryption systems). Research has therefore intensified to develop quantum computers and the market promises to be substantial if the technical challenges can be overcome. If quantum computers can be made to atomic precision, it may help to solve the problems of maintaining all the components in a coherent state, and isolating a qubit from everything except the components that are intended to access it. Qubit modules for quantum computers could be constructed, assuming positional synthesis that is capable of fabricating small planar diamondoid structures with an occasional precisely positioned guest atom (such as a phosphorus [Ref. 11] or heavy-carbon atom [Ref. 12]) embedded in the diamond matrix.

### *Room Temperature Superconductors*

Room temperature superconductors, if possible, would have significant commercial applications for energy savings (particularly if they could be fabricated inexpensively). One of the barriers to studying the physics of high temperature superconductors such as cuprate-perovskite ceramic materials is our limited ability to synthesize complex crystalline structures. A technology that could construct arbitrary permutations of chemically-possible crystal structures would greatly accelerate progress in our search for room-temperature superconducting compounds. Atomic precision is critical in this application, since atomic scale defects can disrupt superconducting behavior [Ref. 13].

<sup>1</sup> A metric analogous to "friction."

## *Molecular Machine Systems*

Current efforts to build molecular machines are limited by our ability to position molecular components, fix them in place, and functionalize them to interact mechanically. For example, the Zettl Group's molecular motor based on multiwalled carbon nanotubes [Ref. 14] could be used to drive other molecular machines, such as a positioning system with sub-Angstrom resolution and repeatability, if the drive nanotube could be connected to similar nanotubes with suitable gearing. Nanotube-based systems with simple gearing have been proposed [Refs. 15-18]. There are still significant engineering challenges; we need the capability to:

- Synthesize atomically-precise support structures for these geared-nanotube systems
- Functionalize the nanotubes by adding gear teeth, perhaps a worm drive
- Position the molecular gears and bearings in three dimensional space
- Fix their positions with suitable welding operations (covalent bonding of the bearings to the support structures)

There is also an important opportunity in carbon nanotube-based computers, memories, and other electronics systems, since diamondoid mechanosynthesis (DMS) [Refs. 5, 19] should also be able to fabricate at least small pieces of carbon nanotubes of any specified diameter or chirality, using hexagonal, pentagonal or septagonal rings. DMS should enable the fabrication of connection stubs between nanotube charge carriers and the underlying substrate in an atomically precise manner, and these connection stubs can be attached to any point along an insulating, semiconducting, or metallic nanotube structure. Short sections of diamond nanowires and small arrays of nanoscale pyramidal diamond field emitters might also be fabricated.

## *High Precision Atomic Clock*

NIST researchers [Ref. 20] designed a MEMS based atomic clock by reducing the size and operating power of the core physics assembly of an atomic clock. The device had a volume of  $9.5 \text{ mm}^3$ , a fractional frequency instability of  $2.5 \times 10^{-11}$  at 1 s of integration, and dissipating less than 75 mW of power. The NIST MEMS device has the potential to bring atomically precise timing to hand-held, battery-operated devices. Wafer-level assembly of the structures could enable low-cost mass-production of thousands of identical units with the same process sequence, and easy integration with other electronics.

APM systems might be able to construct a much smaller, more precise core physics assembly for an atomic clock. This device could have both smaller frequency instability as well as much lower power dissipation. Mass production and integration with other electronic components would be a remaining engineering challenge.

## *High Precision Nanoresonator for Mass Sensing*

Mass sensors have been constructed [Ref. 21] based on a resonating cantilever or beam. The resonant frequency of the resonating cantilever or beam is dependent on the mass of the device. By monitoring the resonant frequency change of the cantilever or beam, any changes in mass of the device can be detected. Resolution increases as device size decreases, and presumably, as structural accuracy increases with concomitant increases in tensile strength, bulk modulus, and shear modulus. In this domain, seemingly small differences make a big difference. It was found with current devices, that the Quality factor increases by a factor 400, from 70 to 28000, by operating the cantilever in vacuum.

## *Carbon Nanotubes and Molecular Wires for Molecular Electronic Devices*

There are at least three short to intermediate term dimensions of improvement: (1) complex nanotube shapes that can only be fabricated using positional control, (2) fabrication of those complex structures at a specific location, and (3) adding positionally controlled interconnects between nanotubes on otherwise self-assembled nanotube electronic structures.

Complex nanotube shapes and structures could be produced by a DMS capability involving tooltips that can be manipulated with 0.2-0.5 Å repeatable precision between workpiece and tool rack. The tool rack could include a minimal toolset that can build diamondoid structures including at least C, H, and Ge atoms, and with buildable structures that include, for example, clean and hydrogenated molecularly-precise unstrained cubic diamond C(111)/C(110)/C(100) and hexagonal diamond surfaces of process-limited size, including some Ge-substituted variants; methylated and ethylated surface structures; handled polyynes, polyacetylene and polyethylene chains of process-limited length; and both flat graphene sheets and curved graphene nanotubes. These structures could provide a range of new application capabilities for semiconductor electronics, sensors, and devices.

Similarly, APM could construct small carbon nanotube structures. Without massive parallelization, we would be

limited to building one-offs, so we would need to concentrate on the highest-value nanotube structures in the highest-value industries, such as molecular electronics. An example would be binding sites. These binding sites processes would be similar to conventional processes like molecular imprinting (which surrounds template molecules with polymers that solidify, then the template is removed, leaving behind binding sites for the template molecule) but would allow greater precision of binding pocket design, and would allow rational design of buildable binding sites from scratch without any need for a template molecule. These binding sites could potentially be used in nanosensor and enzymatic applications.

## Research Topics That Would Address Key Challenges

Four classes of research would address key challenges in producing APM applications. They are: (1) standards and testbeds for programming and measuring the output of APM processes, (2) information theoretic descriptions of the nanoscale structures built by APMs, and methods for manipulating these structures that would program specific patterns of self assembly, (3) methods of interfacing and integrating APM devices into standard electronics packages and systems, and (4) methods of scaling up single APM devices using mass arrays or other parallelization techniques.

## References

- [1] Ralph C. Merkle, "Molecular building blocks and development strategies for molecular nanotechnology," presented at the Seventh Foresight Conference on Molecular Nanotechnology, Santa Clara, CA (1999).  
<http://www.zyvex.com/nanotech/mbb/mbb.html>
- [2] Thomas Kenny, "Tip-Based Nanofabrication (TBN)," DARPA BAA 07-59  
<http://www.fbo.gov/spg/ODA/DARPA/CMO/BAA07-59/listing.html>
- [3] Majumder, et al., "Enhanced Flow in Carbon Nanotubes," *Nature*, v. **438**, (3 Nov. 2005): 44.
- [4] Michel Delaage, "Physico-Chemical Aspects of Molecular Recognition," in Michel Delaage, ed., *Molecular Recognition Mechanisms*, VCH Publishers, Inc., 1991, Chapter 1, pp. 1-13.
- [5] K. Eric Drexler, *Nanosystems: Molecular Machinery, Manufacturing, and Computation*, John Wiley & Sons, New York, 1992, p. 288. [For outer sleeve circumference  $n=9$ , changing inner sleeve circumference  $m$  from 7 to 6 atoms.]
- [6] G. Cuniberti, F. Großmann, and R. Gutiérrez, "The role of contacts in molecular electronics," *Advances in Solid State Physics* **42**, 133 (2002).
- [7] Gregory S Snider and R Stanley Williams, "Nano/CMOS architectures using a field-programmable nanowire interconnect," *Nanotechnology* **18** (2007)
- [8] "Autonomous Atom Assembly," Center for Nanoscale Science and Technology,  
[http://cnst.nist.gov/epg/Projects/STM/aaa\\_proj.html](http://cnst.nist.gov/epg/Projects/STM/aaa_proj.html)
- [9] Miha Furlan and Sergey V. Lotkhov, "Electrometry on charge traps with a single-electron transistor," *Physical Review B* **67**, (2003): 205313.
- [10] N. Zimmerman, W. Huber, A. Fujiwara, and Y. Takahashi, "Excellent charge offset stability in a Si-based single-electron tunneling transistor," *Applied Physics Letters*, **79** (19) (5 NOVEMBER 2001): 3188-3190.
- [11] Andre R. Stegner, Christoph Boehme, Hans Huebl, Martin Stutzmann, Klaus Lips, Martin S. Brandt, "Electrical detection of coherent 31P spin quantum states," *Nature Physics* **2** (December 2006): 835-838.
- [12] M.V.G. Dutt, L. Childress, L. Jiang, E. Togan, J. Maze, F. Jelezko, A.S. Zibrov, P.R. Hemmer, M.D. Lukin, "Quantum register based on individual electronic and nuclear spin qubits in diamond," *Science* **316** (1 June 2007): 1312-1316.
- [13] H. J. Kang, *et al.*, "Microscopic annealing process and its impact on superconductivity in T'-structure electron-doped copper oxides," *Nature Materials* **6** (2007): 224 – 229.
- [14] A. M. Fennimore, T. D. Yuzvinsky, Wei-Qiang Han, M. S. Fuhrer, J. Cumings, and A. Zettl, "Rotational actuators based on carbon nanotubes," *Nature* **424** (24 July 2003): 408-410.
- [15] Jie Han, Al Globus, Richard Jaffe, Glenn Deardorff, "Molecular dynamics simulations of carbon nanotube-based gears," *Nanotechnology* **8**(1997):95-102.  
[http://alglobus.net/NASAwork/papers/MGMS\\_EC1/simulation/paper.html](http://alglobus.net/NASAwork/papers/MGMS_EC1/simulation/paper.html)
- [16] Al Globus, Charles W. Bauschlicher Jr., Jie Han, Richard L. Jaffe, Creon Levit, Deepack Srivastava, "Machine phase fullerene nanotechnology," *Nanotechnology* **9** (1998):192-199.
- [17] Richard Jaffe, Jie Han, Al Globus, "Formation of Carbon Nanotube Based Gears: Quantum Chemistry and Molecular Mechanics Study of the Electrophilic Addition of o-Benzyne to Fullerenes, Graphene, and

- Nanotubes,” First Electronic Molecular Modeling & Graphics Society Conference, 1996.
- [18] Al Globus, Richard Jaffe, “NanoDesign: Concepts and Software for a Nanotechnology Based on Functionalized Fullerenes,” First Electronic Molecular Modeling & Graphics Society Conference, 1996.
- [19] R. A. Freitas Jr., R. C. Merkle, “Introduction to Diamond Mechanosynthesis (DMS),” Nanofactory Collaboration website, 2006;  
<http://www.MolecularAssembler.com/Nanofactory/DMS.htm>
- [20] Svenja Knappe, Vishal Shah, Peter Schwindt, Leo Hollberg, John Kitching, Li-Anne Liew, John Moreland, “A microfabricated atomic clock,” *Applied Physics Letters* **85** (9) (30 Aug 2004): 1460-1462.
- [21] G. Abadal, Z. J. Davis, B. Helbo, X. Borrise, R. Ruiz, A. Boisen, F. Campabadal, J. Esteve, E. Figueras, F. Perez-Murano and N. Barniol, “Electromechanical model of a resonating nano-cantilever-based sensor for high-resolution and high-sensitivity mass detection,” *Nanotechnology* **12**, pp. 100-104 (2001).





## Piezoelectrics and Piezo Applications

### Background

Ferroelectricity, named by analogy to ferromagnetism, refers to the tendency of certain dielectrics to exhibit spontaneous electric polarization (separation of positive and negative charges to opposite sides of the material) that can be reversed in direction by the application of an electric field. A subset of ferroelectrics, pyroelectrics produce a charge separation with change in temperature. A related and sometimes overlapping set of materials, piezoelectrics, exhibit the direct piezoelectric effect by generating electric charge in response to applied mechanical stress. In demonstrating the converse piezoelectric effect, piezoelectric materials produce mechanical stress and/or strain in response to an applied electric field. Piezoelectrics represent an example of a smart material—one that changes its properties in response to external stimuli. Piezoelectric materials are useful as sensors, actuators, transducers, and energy converters.

Following their work with pyroelectricity, Pierre and Paul-Jaques Curie experimentally demonstrated piezoelectricity in the 1880s for certain inorganic crystal structures including quartz and sugar.<sup>i</sup> The “Curie point” of a ferroelectric material (again by analogy to ferromagnetism) is defined as the temperature at which the material loses its ferroelectric properties. Ceramic piezoelectric materials based on the perovskite structure were heavily pursued in the 1940s with most initial work involving barium titanate (BiTiO<sub>3</sub>). Perovskite refers to a general group of crystals with a similar structure and that have the chemical formula ABO<sub>3</sub>, where A and B are cations of different sizes.

The lead zirconate titanate (PZT) (PbTiO<sub>3</sub>:PbZrO<sub>3</sub>) solid solution family of perovskites are the ceramic piezoelectrics most commonly used today. Mechanically-induced slight alteration of crystal cell structure gives rise to the piezoelectric charge generation. Conversely, an applied electric field induces a change in crystal unit cell structure that produces a mechanical deformation (dimensional change).

Above the Curie point perovskites have a simple cubic structure with a symmetric arrangement of positive and negative charges—no net dipole. Below the Curie point, crystals such as BaTiO<sub>3</sub> exist in either tetragonal or rhombohedral forms, each crystal having a dipole moment. In a perfect single crystal, all of the unit cell dipoles are aligned in a single crystal direction, creating an active direction for the piezoelectric response. Most practical bulk piezoelectric ceramic materials, however, consist of many crystalline domains. The piezoelectric response of these materials is greatly enhanced through treatment of the material through a process called ‘poling’.

*In a randomly axed polycrystal ceramic, even if the grains are polar or ferroelectric ... under normal circumstance the random orientation will cancel out any anisotropy engendering a macroscopic center of symmetry which forbids piezoelectricity. For the ferroelectric ceramic however a new anisotropy can be induced since the domain polar vectors can be switched under realizable field. Thus the poling operation which develops a high [remnant] polarization  $P_R$  in the ceramic is essential to destroy the macro center of symmetry taking the material into the texture symmetry group  $\infty mm$ .*

from L.E. Cross, *Ferroelectric Ceramics*.

In electrical poling, a large dc electric field is applied across a piezoelectric sample, for instance in the thickness direction of a plate or disc of the material, at a temperature below its Curie point. Crystalline domains with dipoles that are nearly parallel with the applied field preferentially expand in the direction of the field and the sample increases in the poling dimension. When the poling field is removed the aligned domains remained locked in this configuration and the sample retains a permanent, or remnant, polarization. The vectorial directions of anisotropic response of the piezoelectric material are defined in terms of the direction of the poling field.

While not the first demonstration of piezoelectricity in polymers, the report of strong piezoelectric effect in stretched semicrystalline polyvinylidene difluoride (PVDF) by Heiji Kawai in 1969<sup>ii</sup> sparked much interest in the field of piezoelectric polymers that continues today. Similar to ceramic piezoelectrics, it is the polar crystallites of PVDF that contribute to a remnant polarization in the material and give rise to its piezoelectric properties. In fact, PVDF exists in several crystalline phases (including  $\alpha$ ,  $\beta$ ,  $\gamma$  and  $\delta$ ), with  $\beta$  being the polar phase that exhibits piezoelectric behavior.

In addition to an electric poling step to create anisotropic alignment of the crystalline domains in PVDF, additional processing steps such as stretching films of the polymer are performed to convert the  $\alpha$  phase, the majority phase in a PVDF film when it is formed, to  $\beta$  phase.<sup>iii</sup> Electrical poling may be performed near or above the glass transition temperature of the PVDF, which consists of crystalline regions within amorphous regions, to allow reorientation of the polar crystallites with the field. Cooling of the sample before removing the applied field locks in the orientation. The stretching direction of the polymer is perpendicular to the polarization direction.

Piezoelectric response in materials is inherently anisotropic and is described in terms of third rank tensorial coefficients that relate different forms of electrical and

mechanical energy that are coupled in piezoelectric materials. By convention, sample directions used in the coefficient ( $i, j$  in  $d_{ij}$ ) are labeled as “1” for longitudinal direction, the “2” axis is perpendicular to this (width direction), “3” indicates the axis of applied (measured) field (thickness direction). Shear planes “4”, “5”, and “6” are perpendicular to the directions “1”, “2”, and “3”, respectively.

The piezoelectric charge coefficient,  $d_{ij}$ , relates induced dielectric displacement  $D$  with applied stress  $\sigma$  in the direct piezoelectric effect. In the converse piezoelectric effect  $d_{ij}$  (with units C/N or m/V) relates the induced strain  $x$  to the applied electric field  $E$ . The coefficient  $g_{ij}$  (in units Vm/N or  $m^2/C$ ) relates the induced strain  $x$  to the induced dielectric displacement  $D$  and the applied electric field  $E$  to the applied stress  $\sigma$ . The coefficient  $h_{ij}$  (in V/m or N/C) relates the applied stress to the induced dielectric displacement and the applied electric field  $E$  to the induced strain  $x$ .

## Engineering Structure to Enhance Piezoelectric Performance

Since piezoelectric response is emergent from the structure of piezoelectric materials, much of the effort to optimize and improve performance has been directed at altering and controlling material structure.

For example, alteration of the Zr:Ti ratio in PZT solid solutions changes both the remnant polarization and the dielectric/piezoelectric response. ‘Softening’ of piezoceramics such as PZT by addition of donor aliovalent oxides, where the charge on the cation is larger than that which it replaces in the PZT structure, such as  $Mb_2O_5$ , enhance both dielectric and piezoelectric response at room temperature. Under high electric fields these materials show symmetrical, unbiased hysteresis loops with good ‘squareness’ and lower coercivity.<sup>iv</sup>

For the piezopolymer PVDF, the use of copolymer compositions has improved piezo response and material properties. For PVDF-TrFE (vinylidene difluoride copolymerized with trifluoroethylene), for instance, the Curie temperature is above 100C, compared to 80C for PVDF, and majority piezo-active  $\beta$ -phase naturally forms in cast films without mechanical stretching. Manipulation of crystallinity in piezopolymer films has also been achieved using terpolymers (PVDF-TrFE-CFE (poly(vinylidene-trifluoroethylene-chlorofluoroethylene))),<sup>v</sup> polymer blends (PVDF-TrFE/PMMA (poly (methyl methacrylate))),<sup>vi</sup> and physical treatments (e-beam irradiation) to control mobility of dipoles within the material.<sup>vii</sup>

The ease of processing of polymers has also enabled exploration of particle inclusions in polymers such as PVDF to form piezocomposites. Such inclusions may also be used to effect crystallinity, such as templating of the  $\beta$ -phase in

PVDF using carbon nanotubes.<sup>viii</sup> Inclusion of high dielectric fillers, such as ferroelectric ceramic particles, can also increase the effective dielectric constant of the piezocomposite.<sup>ix</sup> Fillers, including carbon nanotubes, may also be used in the conventional sense to improve and tune the mechanical properties of piezoelectric polymer composites.<sup>x</sup>

Additionally, the figure of merit of the application of a piezoelectric may require performance that a pure material, such as PZT, would have difficulty in achieving by itself. PZT is dielectrically ultra soft ( $k \sim 3000$ ) compared to the quite stiff dielectricity of a polymer ( $k \sim 10$ ). Conversely, a ceramic is elastically very stiff ( $s_{11} \sim 2.10^{-11} m^2/N$ ) compared to an ultra soft polymer ( $s_{11} \sim 30.10^{-11} m^2/N$ ). By engineering the directional geometry of piezoceramic/polymer composite, one may put the relative strengths of each material to the advantage of the transducer application.<sup>iv</sup>

## Piezoelectric Applications

Rochelle Salt (sodium potassium tartrate tetrahydrate) was the piezoelectric material most heavily studied prior to the 1940s. Despite its drawbacks as a practical material (eg. it is friable and water soluble), this early piezoelectric found widespread commercial use. By the late 1940s almost every inexpensive phonograph had a Rochelle Salt bimorph pickup head (produced by the Brush Development Company).

Today piezoelectric materials are used in many applications, both in direct mode (sensing) and converse mode (actuating). Limitations for application of piezoceramics include difficulty in processing of the materials and restrictions in the forms and configurations that can be achieved with ceramics. Limitations for applications of piezopolymers include maximum operating temperatures of around 100C and piezoelectric performance that can be much lower than that of piezoceramics.

As sensors, piezoelectrics are used to detect sound waves, acceleration, strain, fluid flow and motion. They are used, for example, in microphones, electric instrument pickups, automobile airbags, perimeter trespass detectors, sonar detectors, counterfeit coin detectors and stethoscopes.

As actuators, piezoelectrics are used to generate acoustic waves, generate pressure, and control position. They are used, for example, in inkjet print heads, ultrasonic generators, quartz clocks, focused sound arrays, surface probe microscope nano-positioners, light/portable sparker detonators, and linear and rotary electric motors. Mechanical stimulation using piezoelectric elements has also been used to help with wound healing.

The fact that many piezoelectric material systems can be used for both sensing and actuation makes them good candidates for incorporation into smart structures/devices that can both monitor and control. Conversion of

mechanical energy into electrical energy using piezoelectric elements is also a promising and developing field.

## Atomically Precise Manufacturing of Piezoelectric Materials

The ability to assemble atoms at will and so to construct atomically precise piezoelectric ceramic crystals would allow for the experimental measurement of intrinsic piezoelectric properties of crystal lattices as differentiated from the effects of domain walls, phase boundaries, and defects. The difficulty in obtaining verifiable single crystals of some of the most optimally performing  $\text{PbZrO}_3\text{:PbTiO}_3$  (PZT) solid solutions has made study of the intrinsic properties difficult. The ability to place atoms (and defects) controllably into a crystal lattice structure would enable the accumulation of new fundamental knowledge of piezoelectric behavior.

As mentioned above, the polycrystalline nature of formed piezoceramics results in the need to electrically pole piezoelectric elements to align the dipoles of the individual crystallites in the device-active direction. The maximum polarizability that can be obtained this way has theoretical limits that are inherently less than that of a single crystal. A broadening of the polarization also occurs since there is a distribution of alignment vectors for the multiple dipoles. This divergence from perfect alignment is proportional to the number of domains and thus inversely proportional to the grain size in a sample.

Remnant polarization and piezoelectric response are diminished for polycrystalline samples relative to that of a single crystal. Atomic precision in the construction of a piezoelectric ceramic element can eliminate defects, grain boundaries, and variation in crystallite domains. This would enable maximum, single crystal piezoelectric performance. Precise positioning of atoms within a lattice might obviate the need for electric poling as the lattice is created in its desired orientation. Atom-by-atom placement may even allow formation of crystal structures that are piezoelectrically beneficial but not thermodynamically favorable and hence would not form using conventional preparation methods.

The piezoelectric coupling coefficient  $k$  of a material is a dimensionless measure of its efficacy for electromechanical transduction. It is proportional to the piezoelectric stress constant ( $e$ ) of the material divided by the square root of the product of its elastic stiffness ( $c$ ) and dielectric permittivity ( $\epsilon$ ). Alternatively,  $k$  is proportional to the piezoelectric strain coefficient ( $d$ ) of a material divided by the square root of the product of its elastic compliance ( $s$ ) and dielectric permittivity ( $\epsilon$ ). For a non-ferroelectric material, with no remnant polarization,  $k$  is equal to 0. From energy balance considerations, the theoretical maximum value of  $k$  is 1.

State-of-the-art single crystal ferroelectric materials currently approach  $k$  values of 0.9.

Piezoelectric materials with low  $k$  values, such as quartz, are valuable for applications requiring narrow bandwidths, such as filters and resonators, since bandwidth is proportional to  $k$ . Large  $k$  piezoelectric materials, such as PZT, are useful for applications including filters that require large bandwidths. Determination of the placement of atoms in a piezoelectric material lattice would enable tuning of the material for its intended application; maximizing strain produced with electric field for actuators or minimizing dielectric displacement with electric field for narrow bandwidth filters. Though the dipoles in a perfectly aligned piezoelectric material would still misalign over time, the ability to fabricate a single crystal, single domain piezoelectric ceramic with no defects or grain boundaries using atomically precise manufacturing would enable the ultimate minimization of factors contributing to many of the mechanisms for loss and material performance degradation that limit current piezoelectric material performance.

Though their piezoelectric charge coefficient can be an order of magnitude lower than that of PZT piezoceramics, PVDF piezopolymers are used for some piezoelectric applications due to their ease of processing compared to the ceramics. These thermoplastic polymers may much more easily be formed into arbitrary shapes, thin films and patterns than their ceramic counterparts. However, the ability to assemble atoms one-by-one into arbitrary shapes would permit the higher-performing ceramic materials to access many of these applications. It would also enable more arbitrary control over combinations of ceramics and polymers in hybrid structures to engineer ferroelectric and elastic tensor elements.

As well as bulk composition, atomic control of the manufacturing of materials in devices would also enable the engineering of material interfaces. Adhesion between piezoactive elements and electrodes, structures and supports may be greatly improved with the ability to unsharpen the boundaries between them. A graded interface to control mechanical coupling may also compensate for the impedance mismatch that exists between high impedance piezoceramics and low impedance water, enabling medical diagnostic and sonar applications for these materials.

Atomic precision in the construction of piezopolymer structures will eliminate the need for process steps, such as mechanical stretching, to achieve desired piezo-active crystal phases. Control over the dispersion and boundaries between crystalline regions in amorphous polymer and nanofillers in piezopolymer composites will optimize electromechanical coupling responses and efficiencies.

## Further Reading

### Reviews

IEEE UFFC Ferroelectrics Review Articles by L.E. Cross  
<http://www.ieee-uffc.org/femain.asp?view=review>

Characterization, Performance and Optimization of PVDF as a Piezoelectric Film for Advanced Space Mirror Concepts, T.R. Dargaville, M.C. Celina, J.M. Elliott, P.M. Chaplya, G.D. Jones, D.M. Mowery, R.A. Assink, R.L. Clough and J.W. Martin, SANDIA REPORT SAND2005-6846

Piezoelectric Polymers, J.S. Harrison and Z. Ounaies  
 NASA/CR-2001-21142 ICASE Report No. 2001-43

Piezoelectricity: Old Effect, New Thrusts. A. Ballato IEEE Trans. on Ultrasonics, Ferroelectrics, and Frequency Control 1995 42(5) 916-925

### Theory on the Web

Piezoelectric Ceramics: Principles and Applications, APC International, Ltd..  
[http://www.americanpiezo.com/piezo\\_theory/](http://www.americanpiezo.com/piezo_theory/)

Fundamentals of Piezoelectricity, Physik Instrumente (PI) GmbH & Co. KG  
[http://www.physikinstrumente.com/en/products/piezo\\_tutorial.php](http://www.physikinstrumente.com/en/products/piezo_tutorial.php)

<sup>i</sup> J. Curie and P. Curie "Development by Pressure of Polar Electricity in Hemihedral Crystals with Inclined Faces" *Bull. Soc. Min de France*, 3, 90-102 (1880)

<sup>ii</sup> H. Kawai "Piezoelectricity of Poly (Vinylidene Fluoride)" *Jap J Appl Phys* 8 (7): 975- 1969 (1969)

<sup>iii</sup> D.K. Das-Gupta and K. Doughty "Piezoelectricity in uniaxially stretched and corona poled polyvinylidene fluoride" *J. Phys. D: Appl. Phys.*, 13 95-105 (1980)

<sup>iv</sup> L.E. Cross "Ferroelectric Materials for Electromechanical Transducer Applications", *Jpn. J. Appl. Phys.* 34, 2525-32 (1995).

<sup>v</sup> R.J. Klein, F. Xia, Q.M. Zhang, F. Bauer "Influence of composition on relaxor ferroelectric and electromechanical properties of poly(vinylidene fluoride-trifluoroethylene-chlorofluoroethylene)" *J. of Appl. Phys.* 97(9) (2005)

<sup>vi</sup> R. Gregorio Jr. and N.C.P.d.S. Nociti "Effect of PMMA addition on the solution crystallization of the alpha and beta phases of poly(vinylidene fluoride) (PVDF)" *J. Phys. D: Appl. Phys.* 28(2): 432 (1995)

<sup>vii</sup> Q.M. Zhang, V. Bharti, X. Zhao "Giant Electrostriction and Relaxor Ferroelectric Behavior in Electron-Irradiated Poly(vinylidene fluoride-trifluoroethylene) Copolymer" *Science* 280(5372): 2101-2104 (1998)

<sup>viii</sup> N. Levi, R. Czerw, S.Y. Xing, P. Iyer, D.L. Carroll "Properties of polyvinylidene difluoride-carbon nanotube blends" *Nano Lett.* 4(7): 1267-1271 (2004)

<sup>ix</sup> R. Gregorio, M. Cestari, F.E. Bernardino "Dielectric behaviour of thin films of beta-PVDF/PZT and beta-PVDF/BaTiO<sub>3</sub> composites" *J. Mater. Sci.* 31(11): 2925-2930 (1996)

<sup>x</sup> A. Ramaratnam and N. Jalili "Reinforcement of piezoelectric polymers with carbon nanotubes: Pathway to next-generation sensors" *J. Intell. Mater. Syst. Struct.* 17(3): 199-208 (2006)



## Fuel Cell Electrocatalysis: Challenges and Opportunities

An area of concern that is both widespread and growing is energy sources and their availability, environmental effects, and particularly expectations for the future. Many consider that fuel cells eventually will become a major source of clean energy, given their several potentially ideal properties. The expectation is that their application in transportation will be especially vital and important since the uniquely high energy-conversion efficiency of fuel cells may entail a substantial decrease in the adverse environmental effects from using fossil fuels. That may confer on fuel-cell technology the possibility of radically changing global energy relations and politics. Further developing of fuel-cell technology poses considerable challenges, but promising solutions may be in the works.

Despite definitive advances in recent years, existing fuel-cell technology still has several drawbacks: i) the lower than theoretical efficiency of energy conversion, ii) the high Pt content of electrocatalysts and iii) the instability of Pt under potential cycling conditions. These problems are connected to the electrocatalytic O<sub>2</sub> reduction reaction (ORR).<sup>1</sup> The ORR occurs at the fuel cell cathode, and involves the reaction between oxygen, electrons, and protons to produce H<sub>2</sub>O, the final product of the electrocatalytic oxidation of the cell's fuel (H<sub>2</sub>). Even on the best Pt-based ORR catalysts, the kinetics of ORR is rather slow. **Accordingly, improving the activity of Pt for the ORR represents the first great challenge of electrocatalysis.**

Using platinum as a fuel-cell catalyst in automotive applications will cause an unquantifiable increase in the demand for this metal. However, the reserves and availability of platinum are limited, such that this may have serious implications for commercializing this source of clean energy. Some researchers predict that the world's sources of platinum will be exhausted in 15 years;<sup>2</sup> others consider it a difficult, but manageable issue.<sup>3</sup> However, undisputedly, the Pt content in catalysts, its cost and its availability, must be resolved before fuel cell vehicles can become a common means of transportation. **Decreasing the content of Pt, or eliminating it, in fuel cell electrocatalysts is the second great challenge of electrocatalysis.**

Recent work recorded a substantial loss of surface area of Pt over time in proton-exchange membrane fuel cells (PEMFCs) during the stop-and-go driving of an electric car that causes the electrode potential cycling. Thus, **the dissolution of Pt under potential cycling conditions is a third great challenge of electrocatalysis.**

Solving the above three challenges represents a problem of high significance. It is likely that a combination of i)

atomically precise synthesis/manufacturing of catalysts, ii) designing catalysts using advanced theoretical methods and iii) further improvement of *in situ* characterization with atomic specificity and sub-angstrom resolution will be necessary to address successfully this challenges.

The benefits of atomically precise manufacturing may seem difficult to achieve given the system's complexity (different size and shape of metal or alloy nanoparticles, interaction with the Nafion<sup>®</sup> membrane and the carbon substrate). However, small metal nanoparticles of 2 to 5 nm in diameter are single crystal particles **without steps and kinks**. Placing atoms of a catalyst, or catalyst modifier, on the well-ordered facets of a nanoparticle support with atomic precision can be conducive to significantly improving their properties. Thus, we may be able to "tailor" the adlayer structure for a particular reaction to

1. obtain the optimal ensemble effect for a particular reactant
2. optimize the spill-over effect via the right coverage
3. effectuate blocking adsorption of catalytic poisons.

In making membrane electrode assemblies (MEAs) with such well designed catalysts particles, the catalysts' utilization, water management, and gas transport can be improved due to the uniform phase-boundaries and the regularity of mass transport pathways. These examples are not without precedents. Some can be found in the nature, as indicated above.

We recently demonstrated one promising way to address the first two challenges by synthesizing the platinum monolayer electrocatalysts for the hydrogen-oxidation<sup>4,5</sup> and the ORR reactions wherein the Pt content is lowered by one order of magnitude compared with conventional catalysts.<sup>5,6</sup> Catalytic reactions are surface reactions, i.e., they encompass the interactions of a reactant with the top layer (monolayer) of atoms on the catalyst's surface. Thus, in principle, a catalyst can be reduced to a single monolayer supported by a suitable substrate. Accordingly, a monolayer of platinum was placed on the carbon-supported nanoparticles of a metal or alloy. Besides having an ultimately low platinum content, these catalysts show up to a 20-fold increase in Pt mass activity compared to conventional ones. We identified the origin of their increased activity through a combination of experimental methods, employing electrochemical and surface-science techniques, X-ray absorption spectroscopy, and density functional theory calculations.

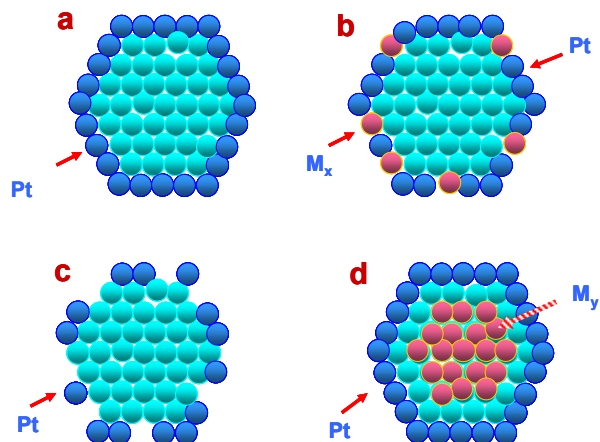

- Quasi cross-sectional schematic of a Pt monolayer on a metal or alloy nanoparticle.
- Mixed Pt-metal monolayer on metal nanoparticle.
- Pt submonolayer (islands) on a metal or alloy nanoparticle.
- Further reduction of the catalysts' noble metal content. Pt monolayer on a non-noble- noble metal core-shell nanoparticle.

**Figure 1. Several possible types of platinum monolayer catalysts**

Figure 1a is a cross-sectional schematic of a Pt monolayer on a nanoparticle of another metal or alloy. In addition to the obviously high utilization of Pt, the activity of the Pt monolayer can be tuned through its interaction with the substrate (enhanced or decreased) via substrate-induced tensile or compressive strain<sup>7-9</sup> that links the change in activity to the shift of the center of the d-band.<sup>8,10</sup> The electronic (ligand) effects can reduce the oxidation of Pt (i.e., the formation of PtOH), thus enhancing the ORR's kinetics. This effect also is observed with a mixed Pt-metal (M) monolayer catalyst. Here, the facile adsorption of OH on M decreased PtOH formation by the lateral repulsion between OHs on the two metals<sup>7</sup> (Figure 1b). Furthermore, with Pt islands (a Pt submonolayer) on a substrate, "ensemble" effects can be observed. A bifunctional catalyst also can be obtained, provided that the substrate acts as a co-catalyst. (Figure 1c). As Figure 1d illustrates, to reduce further the content of the other noble metals that can compose the substrate (Pd, Ru), the substrate's nanoparticle core can be made of a non-noble metal, encapsulated by a noble-metal shell.<sup>11</sup>

To facilitate the synthesis of these Pt monolayer electrocatalysts, we devised two new synthetic methods: the electroless (spontaneous) deposition of Pt on Ru,<sup>12</sup> and the galvanic displacement of a Cu monolayer deposited at underpotentials on substrate nanoparticles, upon immersion in a platinum salt solution.<sup>13</sup> This latter methodology involves an atomically precise synthesis of catalysts (monolayer thickness), while the coverage of Pt is controlled by the Cu coverage placed on the support nanoparticle. The approach offers has a great versatility for synthesizing catalysts. We recently developed a method of similar versatility for **placing metal nanofilms on oxide surfaces**. It involves cation adsorption on oxide surfaces, followed by their electrochemical or chemical reduction and the galvanic

displacement of reduced cations by a more noble metal. (Patent Application, 2007).

Figure 2 presents a verification of the Pt monolayer on Au/Ni core-shell nanoparticles obtained by scanning probe energy dispersive spectroscopy in a transmission electron microscopy set up.

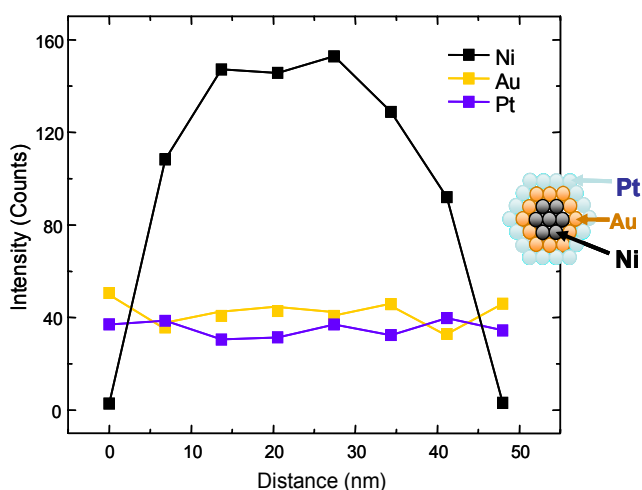

**Figure 2. Distribution of components in a Pt monolayer on a Ni-Au core-shell nanoparticle, Pt/Au/Ni<sub>5</sub>/C, obtained by scanning probe energy dispersive spectroscopy**

There have been many efforts to synthesize non-noble metal electrocatalysts and although remarkable progress is being made, but the activity of such catalysts is still too low. A considerable advances also have been made in the

theoretical treatment of catalytic systems, in particular in employing density functional theory (DFT), which can help in designing new, better catalysts<sup>14,15</sup>. Figure 3 displays the DFT calculated structures of top layers of PdFe alloys and predicted current densities of a Pd overlayer on Pd<sub>3</sub>Fe(111) and on PdFe(111) based on the calculated oxygen-binding energy in comparison with experimental data. The results predict the possibility of designing a Pd alloy catalyst having higher activity than that of Pt.<sup>16</sup>

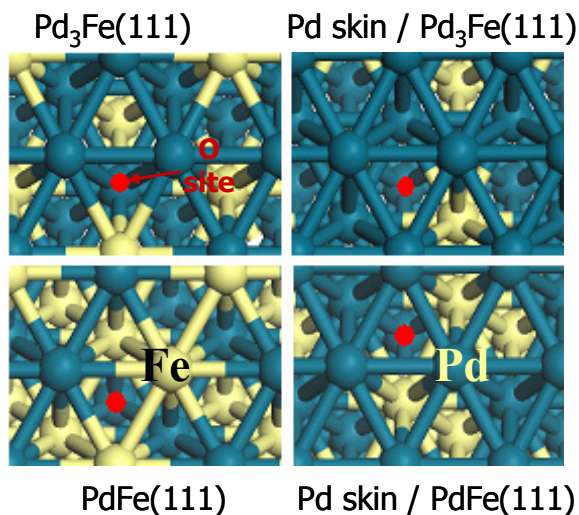

**Figure 3a.** Top view of a) Pd<sub>3</sub>Fe(111), b) Pd overlayer on Pd<sub>3</sub>Fe(111), c) PdFe(111), and d) Pd overlayer on PdFe(111). The yellow and blue balls represent Fe and Pd atoms, respectively. The red dots indicate the most stable sites for O adsorption on each surface.

The most telling evidence for the long-term stability of Pt monolayer catalysts was obtained in operational fuel cell tests. Thus, no decline in activity was found over 900 hours with an anode catalyst; small losses occurred in 2400 hours in a similar test. The cathode catalyst exhibited a moderate loss of activity for over 3000 hours.

In another example of fuel cell tests Figure 4 displays the polarization curves in MEAs for a Pt monolayer catalyst on Pd/C and mixed (Pt +Ir) monolayer (80:20) on Pd/C catalyst in comparison with commercial Pt/C catalyst.<sup>17</sup> The Pt mass activities of monolayer catalysts are by factor of 4-6 larger than that of a commercial Pt catalyst.

The third challenge involving the dissolution of Pt under potential cycling conditions was successfully addressed under laboratory conditions by modifying Pt with a

The stability of Pt monolayers catalysts clearly is the major question in realizing their potential. To avoid unwanted segregation effects, Pt and the supporting metal should constitute a strongly surface-segregated system in which Pt is thermodynamically stable at the surface of nanoparticle.

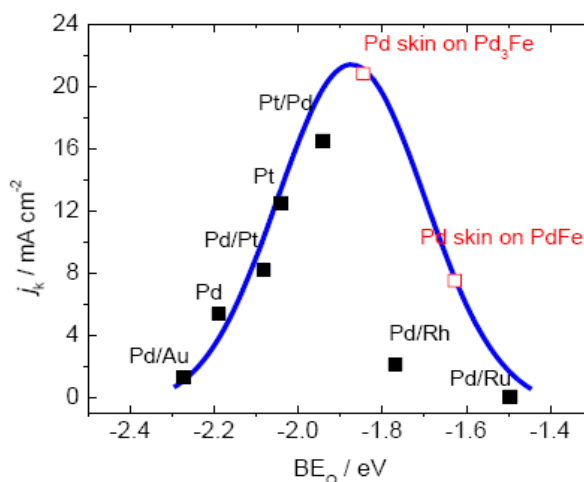

**Figure 3b.** Volcano dependence of the ORR activity (expressed as the kinetic current density at 0.8 V vs RHE; rotation rate 1600 rpm; room temperature) on the calculated oxygen-binding energy. The experimental data and the predicted current densities of the Pd overlayer on Pd<sub>3</sub>Fe(111) and PdFe(111) based on the calculated oxygen-binding energy are shown, respectively, as the solid and open squares.

submonolayer of Au clusters. Au enhances the stability of Pt nanoparticles by shifting the latter's oxidation to more positive potentials, and by blocking the kink and step sites for O adsorption.<sup>18</sup>

Studies involving the concept of platinum monolayer electrocatalysts are at an early stage. However, the results reported so far indicate that such electrocatalysts are likely to afford a solution to the problem of large Pt loadings in fuel-cell electrodes, and will significantly ameliorate the problems of their insufficient activity and stability. A sustained research effort with continuing focus on catalysts performances helped with new developments in nanoscience and nanotechnology, in particular with atomically precise synthesis and new theoretical and *in situ* characterization methods will succeed in making fuel cells power sources a reality.

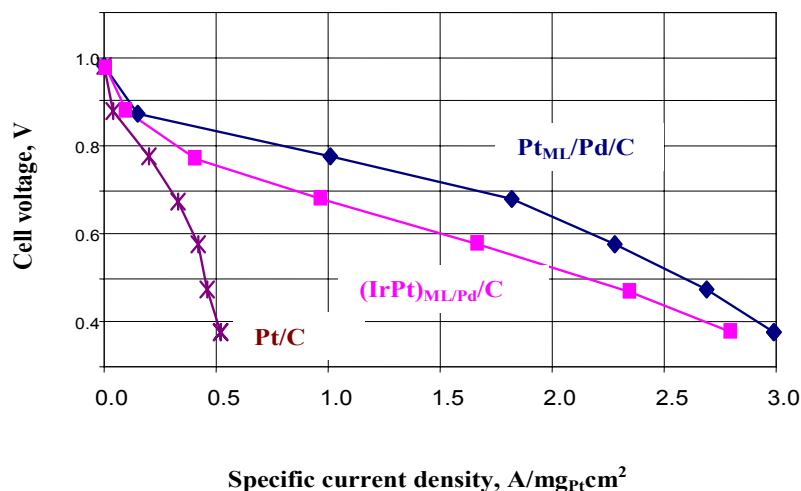

**Figure 4. Polarization curves (Pt mass-specific) for a Pt monolayer catalyst on Pd/C and mixed Pt+Ir monolayer (80:20) on Pd/C in comparison with commercial Pt/C catalyst.**

## References

- (1) Adzic, R. R. Recent advances in the kinetics of oxygen reduction. In *Electrocatalysis*; Jacek Lipkowski, P. N. R., Ed.; Wiley-VCH, Inc., 1998; pp 197.
- (2) Cohen, D. *New Scientist* **2007**, 34.
- (3) Garland, N. L.; Milliken, J.-A.; Carlson, E.; Wagner, F. T. *SAE Technical paper series* **2002**, 01, 1896.
- (4) Brankovic, S. R.; Wang, J. X.; Adzic, R. R. *Electrochemical and Solid State Letters* **2001**, 4, A217.
- (5) Sasaki, K.; Mo, Y.; Wang, J. X.; Balasubramanian, M.; Uribe, F.; McBreen, J.; Adzic, R. R. *Electrochimica Acta* **2003**, 48, 3841.
- (6) Zhang, J.; Mo, Y.; Vukmirovic, M. B.; Klie, R.; Sasaki, K.; Adzic, R. R. *J. Phys. Chem. B* **2004**, 108, 10955.
- (7) Zhang, J. L.; Vukmirovic, M. B.; Sasaki, K.; Nilekar, A. U.; Mavrikakis, M.; Adzic, R. R. *Journal of the American Chemical Society* **2005**, 127, 12480.
- (8) Hammer, B.; Nørskov, J. K. Theoretical surface science and catalysis - Calculations and concepts. In *Advances in Catalysis*; Academic Press Inc: San Diego, 2000; Vol. 45; pp 71.
- (9) Greeley, J.; Mavrikakis, M. *Nature Materials* **2004**, 3, 810.
- (10) Mavrikakis, M.; Hammer, B.; Nørskov, J. K. *Phys. Rev. Lett.* **1998**, 81, 2819.
- (11) Zhang, J.; Lima, F. H. B.; Shao, M. H.; Sashikata, K.; Wang, J. X.; Hanson, J.; Adzic, R. R. *J. Phys. Chem. B* **2005**, 109, 22701.
- (12) Brankovic, S. R.; McBreen, J.; Adzic, R. R. *Journal of Electroanalytical Chemistry* **2001**, 503, 99.
- (13) Brankovic, S. R. W., J.X.; Adzic, R.R. *Surface Science* **2001**, 477, L173.
- (14) Hammer, B.; Nørskov, J. K. *Adv. Catal.* **2000**, 45, 71.
- (15) Zhang, J.; Vukmirovic, M. B.; Xu, Y.; Mavrikakis, M.; Adzic, R. R. *Angew. Chem. Int. Ed* **2005**, 44, 2132.
- (16) Shao, M.; Liu, P.; Zhang, J.; Adzic, R. R. *J. Phys. Chem. B* **2007**, 111, 6772.
- (17) Sayre, J.; Sessler, M.; Kawczak, A.; Zhang, J.; Adzic, R. R. *in preparation* **2007**.
- (18) Zhang, J.; Sasaki, K.; Sutter, E.; Adzic, R. R. *Science* **2007**, 315, 220.

## Atomic Precision Materials Development in PEM Fuel Cells

A fuel cell is an electrochemical device that continuously converts chemical energy into electric energy and some heat for as long as fuel and oxidant are supplied.<sup>1</sup> At the heart of the PEM fuel cell is a membrane electrode assembly (MEA). The MEA includes a membrane made from a polymer electrolyte or proton conducting polymer. The polymer electrolyte membrane is sandwiched between a pair of electrodes called an anode and a cathode. The MEA also usually includes porous, electrically conductive sheets called gas diffusion layers positioned adjacent to the electrodes to permit diffusion of reactants to the electrodes.

In operation, a fuel such as hydrogen or methanol is flowed into contact with the anode where it dissociates into electrons and protons. The electrons, which cannot pass

through the membrane, flow from the anode to the cathode through an external circuit containing an electric load, which consumes the power generated by the cell. The protons pass through the membrane and combine with oxygen and electrons on the cathode to produce water and heat.

Although fuel cells have been around since 1839, their wide use has been hindered by high cost and poor performance/durability. There are critical research challenges at the atomic level that must be met to overcome these barriers to develop next-generation PEM fuel cell technologies. The list of challenges is too exhaustive for this paper. Therefore, the focus of this paper is on those associated with PEM fuel cell stack components (see Table 1), in particular the membrane and electrodes.

**Table 1. Stack component critical attributes.**

PEM Stack Components	Critical Attributes*
Polymer electrolyte membrane	High protonic conductivity Low reactant permeability Optimal water balance
Catalyst layer / electrodes	Allow simultaneous access of protons, electrons and oxygen to as many catalytically active sites as possible.
Gas diffusion layers	High reactant and product permeability High electrical and thermal conductivity
Bipolar plates	High electrical and thermal conductivity Corrosion resistance
Seals and gaskets	Good chemical resistance Resistance to set, creep

\* There are many more required attributes of stack components than tabulated here; only a few critical ones are shown.

Atomically precise structures, such as self-assemblies, crystalline morphologies, nanostructures, and biocomponents are critical in PEM fuel cell technologies. There are numerous limits in today's synthesis and fabrication capabilities. Atomically precise, multifunctional systems are needed.

Precise internal structure materials with novel properties, such as ionic conductivity, are necessary for enabling fuel cell membranes. Most current membranes rely on sulfonated groups for proton transport. Post sulfonation methods lack control over the degree and location of functionalization. Direct copolymerization of sulfonated monomers can overcome this drawback by enhancing the stability and increasing the acidity by placing the sulfonic groups on the deactivated sites of the repeat units. However, there is still a clear need for the synthesis of new PEM polymeric materials. Polymers bearing functional moieties for proton conduction might also be designed to serve as

hosts for inorganic compounds to afford a proton conducting component in a blend, as well as a standalone PEM. The two current hurdles for polymeric membranes are the high protonic conductivity at low water contents and long-term durability under fuel cell conditions. Current sulfonic acid-based materials suffer from low conductivity in the absence of water. New proton conducting moieties and morphologies are required to fulfill the requirements of these higher temperature systems.<sup>2</sup>

Unique assembly of atomically precise, complex, multicomponent structures are needed in the electrodes. As noted earlier, the critical attribute of the electrode is to allow simultaneous access of protons, electrons and oxygen to as many catalytically active sites as possible, see Figure 1. To meet this need, self-assembling, multicomponent systems must be engineered with tailored nanostructured morphologies and pores to yield high conductivity, optimal water balance, and improved O<sub>2</sub> permeability.



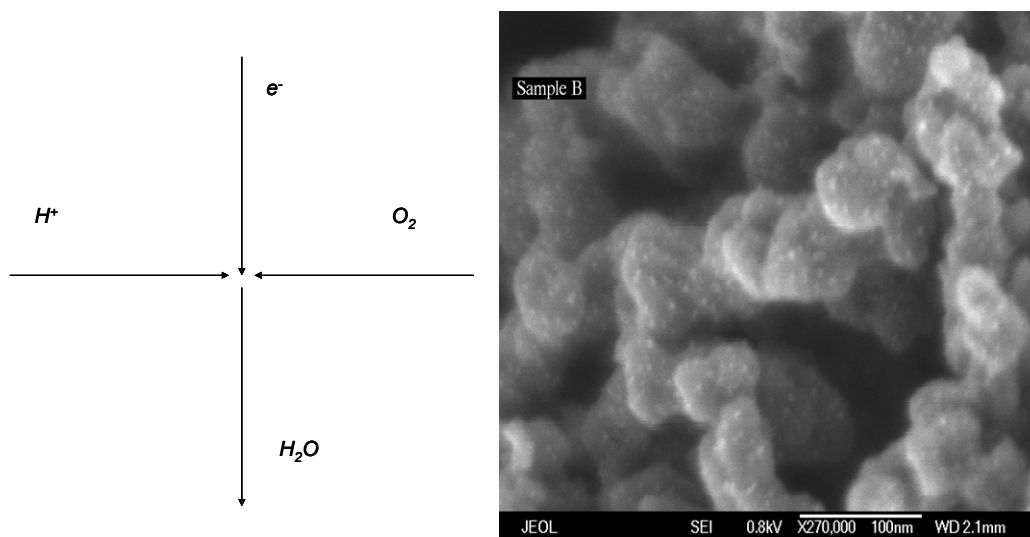

**Figure 1. Field-emission scanning electron micrograph of fuel cell electrode and representative schematic.**

## References

1. Hoogers, G., *Fuel Cell Technology Handbook*. CRC Press: Washington, DC, 2003; p 1-1.
2. Hickner, M. A.; Ghassemi, H.; Kim, Y. S.; Einsla, B. R.; McGrath, J. E., Alternative polymer systems for proton exchange membranes (PEMs). *Chemical Reviews* **2004**, 104, (10), 4587-4611.

## Hydrogen Storage

One of the greatest demands for the realization of a hydrogen based energy economy is the development of new materials and approaches to store hydrogen with sufficient energy densities for fuel cell powered devices. The challenges are greatest for on-board storage system, where there are strict volumetric, gravimetric, and kinetic constraints. The 'System' is everything that is needed to get the hydrogen from the storage material to the fuel cell. In short, the hydrogen storage system must weight no more than, and take no more volume than, the competing technology, a gasoline delivery system. The kinetics of desorption and resorption are defined by the need to deliver hydrogen to the fuel cell stack at rates up to 2 grams H<sub>2</sub>/sec and be completely recharged at a fueling station within a few minutes. Furthermore, the discharge and recharge of the storage material must be capable of repeating this feat over several cycles (or refuelings). To meet these kinetic challenges scientists and engineers have place a major focus on the thermodynamics of the storage material. There is a very narrow window of thermodynamic opportunity that will permit the economical operation of fuel cell powered vehicles. The DOE website [www1.eere.energy.gov/hydrogenandfuelcells](http://www1.eere.energy.gov/hydrogenandfuelcells) is frequently updated with the requirements for on-board hydrogen storage materials.

Because neither high pressure nor liquid hydrogen storage approaches can meet long term DOE targets there are two other general approaches to storing hydrogen in condensed phases that are under investigation: (1) physi-sorption on high surface area materials and (2) chemi-sorption on compounds built from light atoms. The technical challenges are to increase the binding energy of physi-sorbed hydrogen and/or to decrease the binding energy of chemi-sorbed hydrogen. Research on Physi-sorption storage approaches has focused on high surface area materials. Molecular Organic Frameworks (MOFs) have received significant attention due to the ability to make reproducible nano building blocks using metallic anchors with organic linkers. Research on Chemi-sorption storage approaches has focused on design of new materials with tunable thermodynamics. It is commonly accepted knowledge in the scientific community that nano-scaling of chemi-sorption materials will have two significant benefits for hydrogen storage: (1) enhanced kinetics due to shorter diffusing lengths and (2) tunable thermodynamics through modification of particle size.

However, outside of theoretical predictions there have been only a few experimental examples to qualify the enhanced properties of nano-scale materials. Especially challenging are methods to preserve the nano scale properties of materials through the discharge/recharge cycling of hydrogen materials. One approach that has been

successful is to utilize a 'nano scaffold' to hold conventional storage materials in nano scale dimensions. PNNL demonstrated the modification of thermodynamics and enhancement in kinetics for ammonia borane (19.6 wt H<sub>2</sub>) embedded in mesoporous silica (pore diameter 7 nm); The University of Utrecht in The Netherlands demonstrated enhanced storage properties of NaAlH<sub>4</sub> supported on carbon nanofibers [2] and a group for HRL in the DOE Metal Hydride CoE demonstrated the enhanced properties of LiBH<sub>4</sub> embedded in the nanopores of carbon aerogels [3].

Very little discussion has focused on the potential of performance improvement brought about from atomic precision in hydrogen storage but we can envision the beneficial advantages. With Atomic Precision one can design the 'Perfect' Hydrogen Store. The perfect storage material will have the optimum thermodynamics and rapid kinetics for hydrogen sorption and desorption. Atomic Precision will enable synthesis of the precise composition of elements and fabricated at the precise physical dimensions to provide the perfect hydrogen store. Theory can be used to guide experiment. There are a growing number of examples in the literature using computational approaches to predict how thermodynamics can be tuned in nanoscale particles. More recently there have been presentations discussing how the alloying Mg nanoclusters with other elements offer a mechanism to tune the thermodynamics of Mg storage materials [4].

## References

- [1] A. Gutowska et al., *Angew Chem. Int. Ed* 2005, 44, 3578.
- [2] C.P. Balde et al., *Angew. Chem. Int. Ed.* 2006, 45, 3501.
- [3] P. Liu and J.J. Vajo, [www.hydrogen.energy.gov/pdfs/review07/st\\_18\\_liu.pdf](http://www.hydrogen.energy.gov/pdfs/review07/st_18_liu.pdf)
- [4] W. Stier et al. *Prepr. Pap. –Am Chem. Soc., Div Fuel Chem.* 2005, 50, 15.



## The Potential of Atomically Precise Manufacturing in Solid State Lighting

More than any other technology, the absence of artificial lighting would profoundly degrade our quality of life. It also uses an enormous amount of energy; 22% of the nation's electricity (or 8% of the nation's total energy) was used for artificial lighting in 2001. The cost of this energy to the consumer was roughly \$50 billion per year or approximately \$200 per year for every person living in the US. The cost to the environment, furthermore, was approximately 130 million tons of carbon emissions. The artificial lighting we take for granted, however, is extremely inefficient, primarily because conventional technologies generate light as a by-product of energetic processes such as heat or a plasma. Incandescent lamps (a heated wire in a vacuum bulb) convert only about 5% of the energy they consume into visible light, with the rest emerging as heat. Fluorescent lamps (a phosphor-coated gas discharge tube, invented in the 1930s) achieve a conversion efficiency of only about 20%. These low efficiencies contrast starkly with the relatively high efficiencies of other common building technologies: heating is typically 70% efficient, and electric motors are typically 85-95% efficient.

Solid-state lighting (SSL) offers the potential to revolutionize the efficiency of artificial light. It can be defined as the *direct* conversion of electricity to visible white light in a semiconductor and has the potential to convert energy directly to light with very little co-generation of heat. It accomplishes this by avoiding the energetic processes characteristic of traditional incandescent and fluorescent lighting; taking the heat out of lighting, in other words. Recently, for example, SSL devices emitting infrared light have demonstrated<sup>1</sup> an efficiency of 76%. There is no

### Organic Light Emitting Devices

Organic light emitting devices (OLEDs) are based on thin films are based on largely amorphous films of molecular materials and, until recently, have been developed for applications in flat-panel displays. The films are conventionally deposited either by physical vapor deposition in a vacuum or by casting from a solution using techniques such as spin coating or printing. The films are on the order of only a few tens of nanometers thick but there is currently little or no control of their structure at the molecular level. (Structural control of the crystal structure of organic materials using molecular engineering to control, for example, hydrogen bonding is well known but such bulk crystalline materials generally do not emit light and cannot be deposited as thin films.

known fundamental physical barrier to achieving similar (or even higher) efficiencies for visible white light, perhaps approaching 100% efficiency, if we could arrange the charge transporting and light emitting building blocks in exactly the right order.

Today, SSL suitable for illumination has a power conversion efficiency significantly less than 100%. This, combined with the high purchase cost of SSL (too high by a factor of 10 – 100x) results in a cost of ownership too large to be competitive with conventional lighting technologies. The potential for atomically precise manufacturing to impact the field of energy efficient solid state lighting is multifold: Many materials must be combined in order to form a light emitting device, each individual material working in concert with the others to control the flow of electrons so that all their energy produces light. Today, novel light-emitting and charge-transporting materials tend to be discovered rather than designed “with the end in mind”. To approach 100% efficiency will require the ability to design the fundamental atomic or molecular building blocks so that they assemble into a structure which simultaneously optimizes the processes of charge injection and transport to a recombination region where non-radiative modes of recombination are totally suppressed. In short, molecularly precise manufacturing is required. Three examples of potential impact in the field of molecular light emitting semiconductors will be given here. Many of the arguments could equally well be applied to conventional semiconducting materials or hybrid structures containing quantum dots or, more ambitiously, light emitting carbon nanotubes.

The emission of light from an OLED is the result of a cascade of fundamental physical processes. In order to maximize the efficiency of these processes, state-of-the-art OLEDs employ multiple organic layers between two electrodes (Figure 1). The first process that takes place upon application of a bias in an OLED is the injection of electrons and holes from the electrodes (cathode and anode, respectively) into the adjacent organic films. The next step is charge transport, where the electrons and holes drift towards opposite electrodes. If and when electrons and holes meet somewhere inside the organic films, neutral excitons form which can subsequently diffuse. Recombination of the exciton can result into the emission of a photon or can be non-radiative via energy transfer to phonon modes. The flexibility of carbon chemistry leads to an enormous (potentially infinite) range of organic molecules that can be

synthesized for charge transport and light emission but the potential for atomic precision between the molecular building blocks of an OLED is largely unexplored territory.

There is a great deal of similarity in the processes of charge injection, transport and recombination that give rise to the phenomenon of electroluminescence in both organic and conventional, inorganic LEDs. The detailed physics of the processes, however, are different, due to the different nature of electronic excitations in organic and inorganic materials. Organic thin films are extremely thin, typically on the order of 100 nm thick, and therefore even low voltage devices operate at extremely high electric fields on the order of  $10^8$  V/m. This is partly due to the low charge carrier mobility of organic thin films. Under these conditions, charge moves perpendicular to the electrodes and the entire OLED area emits light. Current-spreading layers are not required. We will explore the implications of such mechanisms on the potential for molecularly precise assembly below.

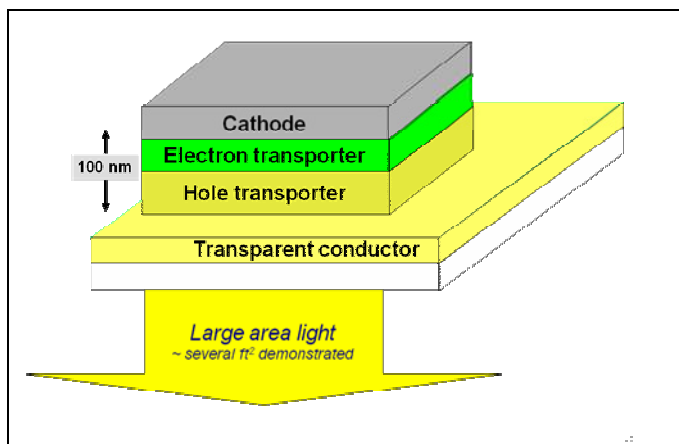

**Figure 1.** The simplest efficient OLED structure (state of the art devices contain many more interfacial and charge-blocking layers).

The hole transporting and electron transporting layers are made up of different organic molecules. One or other of these layers is usually doped with a few percent of an efficient organic phosphor.

## Molecular Building Blocks to Achieve Tailored Photophysical Properties

Significant advances in organic light emitting device (OLED) technology have occurred over the last decade due both to the development of new organic materials and optimization of device architectures. Because of this progress, the efficiency of OLEDs has increased to the point where they are within range of solid state lighting applications but realizing this potential requires the generation of *white* light and the most efficient OLEDs demonstrated to date are green or red. In these colored devices, however, internal quantum efficiency (IQE, the percentage of injected electrons which generate a photon) in excess of 80% has indeed been demonstrated and various schemes exist to improve the optical out coupling at least to 50%, which would make organic SSL extremely competitive in terms of power efficiency. In all cases, however, the most efficient materials on the basis of IQE (and the only materials which have demonstrated IQEs > 80%) are guest-host composites consisting of up to 20% of a small molecule organometallic phosphor in a charge transporting host material. Light comes from the phosphor due to either energy transfer from the host, direct trapping of charge on the phosphor or a combination of the two processes. To generate a pure white light suitable for general lighting, blue light must be mixed with the green and red and it is currently the relatively low efficiency of blue light emission that limits the overall efficiency and stability of white OLEDs.

Efficient blue OLEDs require host materials with an especially wide separation between the LUMO and HOMO. Such materials are often termed “wide bandgap” by analogy with inorganic semiconductors. Now, certain classes of organic molecules with relatively weak inter-molecular interactions (sometimes called Van der Waals bonded solids) can be considered as molecular quantum boxes, where the bandgap can be increased by shrinking the size of the molecule or, more accurately, by decreasing its conjugation length. (These are both over-simplifications but sufficient to grasp the general concept. More accurate interpretations can be found in the literature.<sup>2,3</sup>) It is difficult to achieve this in practice, however, because there is a tradeoff between decreasing the conjugation length to widen the bandgap and adversely affecting both the thermal stability and charge transport properties of the bulk material. For example, wide bandgap small molecules such as cabazole, dibenzofuran and dibenzothiophene (Figure 2b, bottom) are well known but all form solids with low melting points and poor charge transport properties. Using molecular engineering, however, it has recently been demonstrated that such building blocks can be incorporated into larger, tractable molecules with excellent electron transport properties by using saturated linkers to extend the size of the molecule without extending its conjugation length. Such a molecular construct is shown in Figure 2 (b), where the “active bridge” is so named because it is the molecular unit which defined the photophysics of the molecule. A particular case where the



saturated linker is a phosphine oxide group is shown in Figure 2a, where it can be seen that the absorbance (abs), fluorescence (em) and phosphorescence (77K phos) of 4,4'-bis(diphenylphosphine oxide)biphenyl<sup>4</sup> is almost identical to that of the small molecule 4,4'-dibromobiphenyl. Similar demonstrations have been published for other bridges.<sup>5</sup>

This demonstrates the general potential for using organic chemistry to build precise molecular structures with tailored

photophysical properties. It does not demonstrate the final goal of atomic precision across macroscopic length scales but is an important first step, allowing the fabrication of larger and more useful *building blocks* from atomic components. Such a general design strategy will be essential for creating efficient molecular solid state lighting.

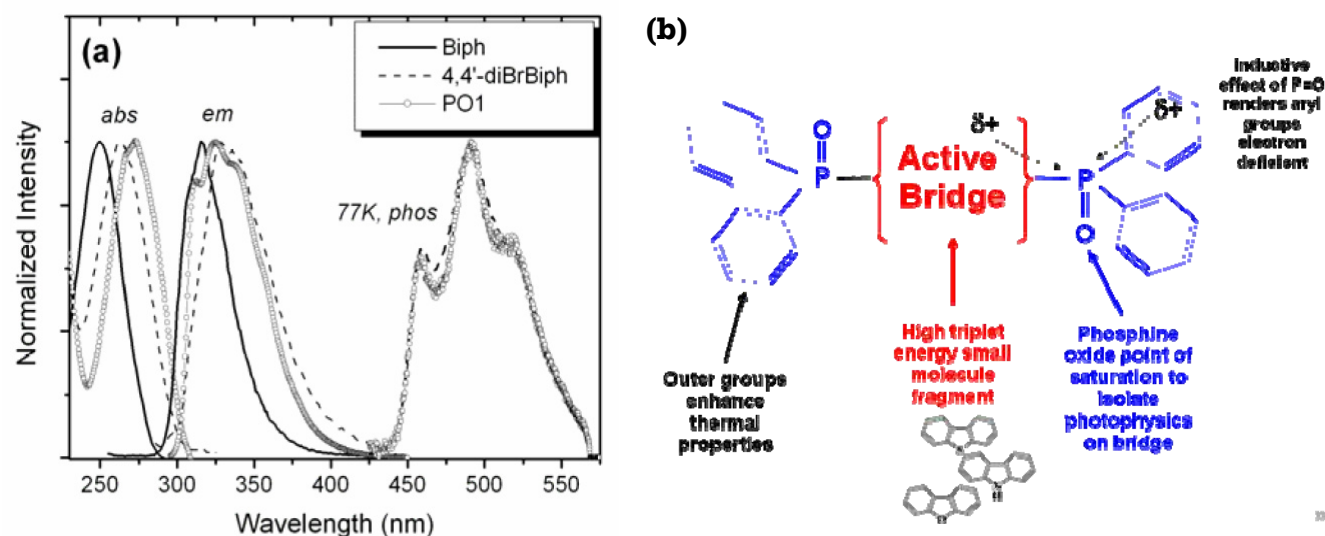

**Figure 2.** (a) Demonstration that the photophysics of a molecule built with P=O linkages is identical to the original biphenyl core. (b) Design scheme for molecular building blocks assembled into an electron transporting molecule suitable for high efficiency OLEDs.

## Precise Positioning of Light Emitting Elements to Increase the Probability of Energy Emission Into Radiative Modes.

The key to high efficiency SSL is using electrons to produce only light, not heat. The most fundamental process inside a solid state lighting device is the generation of atomic or molecular excited states which subsequently relax to the ground state, accompanied by the emission of a photon. The efficiency of this process can be reduced by competition with non-radiative modes of recombination either intrinsic to a molecule or externally induced, by image charge quenching in a nearby metal for example. It is also well known that coupling radiative modes to surface plasmon modes in, for example, a metal nanoparticle, can reduce the radiative excited state lifetime and therefore increase the efficiency of light emission by reducing the time available for non-radiative modes to leak away energy. A surface plasmon is a type of electromagnetic wave propagating along the *surface* of a conductor (hence the

sensitivity of such species to nanoscale structure). The metal is usually gold, silver, platinum or the like.

An excellent demonstration of the potential for the coupling of radiative states into surface plasmons to radically improve the efficiency of light emission was recently published<sup>6</sup> and is summarized in Figure 3. An 80 nm gold nanoparticle was mounted on the end of a tapered optical fiber, irradiated with a laser beam and scanned by means of a tuning fork crystal above an oriented organic molecule randomly cast on a glass coverslip. The fluorescence intensity measured from the organic molecule is also shown in Figure 3 and shows more than a factor of three enhancement at very close (nanometer) separation of the molecule from the metal sphere. Too close, though, and quenching kicks in, destroying the plasmon resonance enhancement. Maximum fluorescence intensity is only

obtained over a *very* narrow range of separation. Sub-nanometer positioning accuracy would be required in order to assemble a device which was to fully take advantage of the physics demonstrated here.

We do not currently have the synthetic techniques to combine molecular building blocks with monodisperse noble

metal nanoparticles with atomic precision in the recombination zone of an electroluminescent device. If such techniques could be developed, the efficiency of fluorescent OLEDs and conventional LEDs could likely be increased multifold, with a concomitant increase in the efficiency of solid state lighting devices.

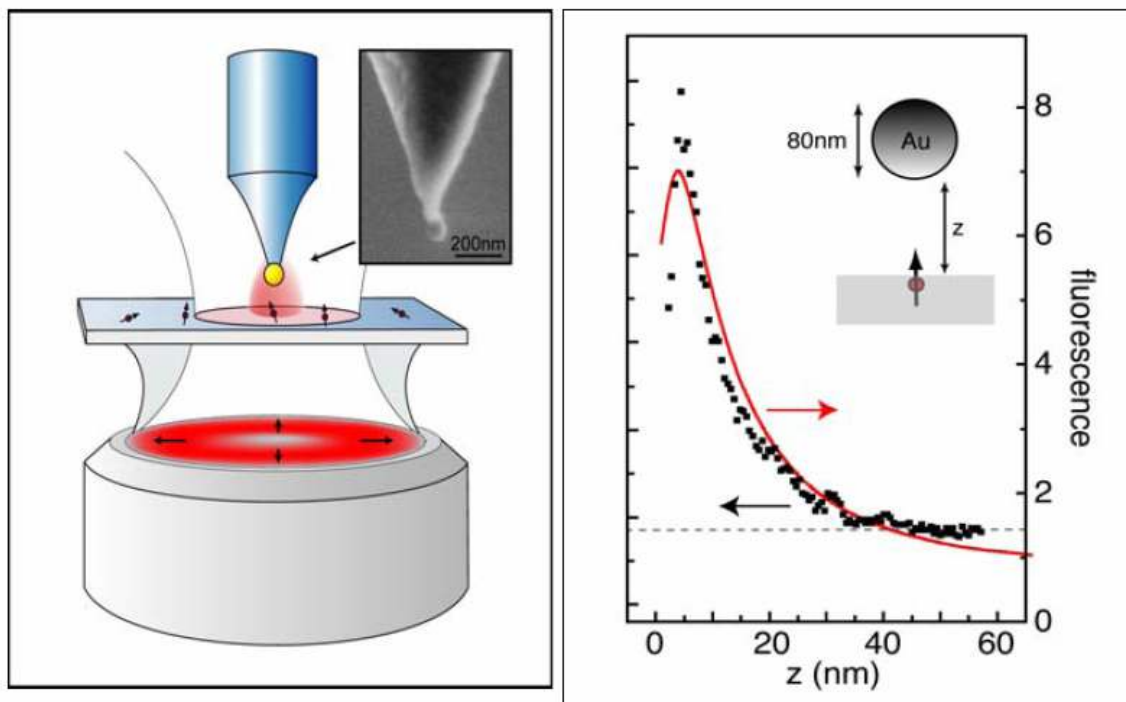

**Figure 3. Experiment (left) and results (right) showing that the fluorescence efficiency of an organic molecule can be dramatically enhanced by its proximity to a gold nanoparticle, from ref. vi.**

## The Precise Placement of Molecules to Optimize Charge Transport

The arrangement of molecular building blocks is particularly important to maximize the effectiveness of charge transport. Today, efficiency is lost in an organic light emitting device because of voltage dropped across an injection barrier for electrons and holes and the relevant molecular states at both the cathode and anode, respectively. Still more efficiency is lost via voltage dropped across the bulk resistance of the molecular thin films themselves, which are largely amorphous.

While we can usefully think of electrons and holes moving in conduction and valence bands on conventional semiconductors, the presence of an extra electron on a molecular unit causes the bond structure of the molecule to change in order to minimize the free energy of the additional charge. This forms a hybrid charged species known as a polaron.<sup>7</sup> Charge carriers therefore tend to be relatively localized on an individual site and the concept of conduction

band and valence band are generally replaced by lowest unoccupied molecular orbital (LUMO) and highest occupied molecular orbital (HOMO), respectively.

So, whereas the local orientation of a particular gallium nitride cluster in a conventional light emitting diode is of secondary importance, the orientation of one molecular building block with respect to its neighbor is utterly critical for effective charge transport because the overlap integral between unoccupied and occupied molecular orbitals in adjacent molecules will partly determine the electron transfer rate between them. Again, this is a conceptual simplification and far more detailed physics (such as the molecular reorganization energies of the radical cation or anion) is required to fully understand the processes and design efficient charge transporting molecules. Theoretical understanding of these processes, coupled with the inexorably increasing speed of the computers which crunch

the numbers, has advanced significantly in recent years.<sup>8</sup> An example model calculation is shown in Figure 4. The spatial distribution of the orbital density of electrons and holes is shown as light- and dark-grey lobes on the molecular structure of a molecule of tetracene. The graphs show the calculated transfer integrals for electron and hole transfer as a function of the degree of translation of one molecule along its long axis (left) and short axis (right), with the intermolecular distance set at 3.74 Å. Clearly, huge differences in transfer efficiency are obtainable simply by

displacing one molecule a few Ångstroms with respect to its neighbor. These effects cannot currently be exploited because we lack the technology to assemble the bulk structure with molecular precision. If we could do so, the potential exists for OLEDs which work at an operating voltage equal to the photon energy and, in direct consequence, molecular solid state lighting with close to 100% of the thermodynamic efficiency for conversion of electricity to light.

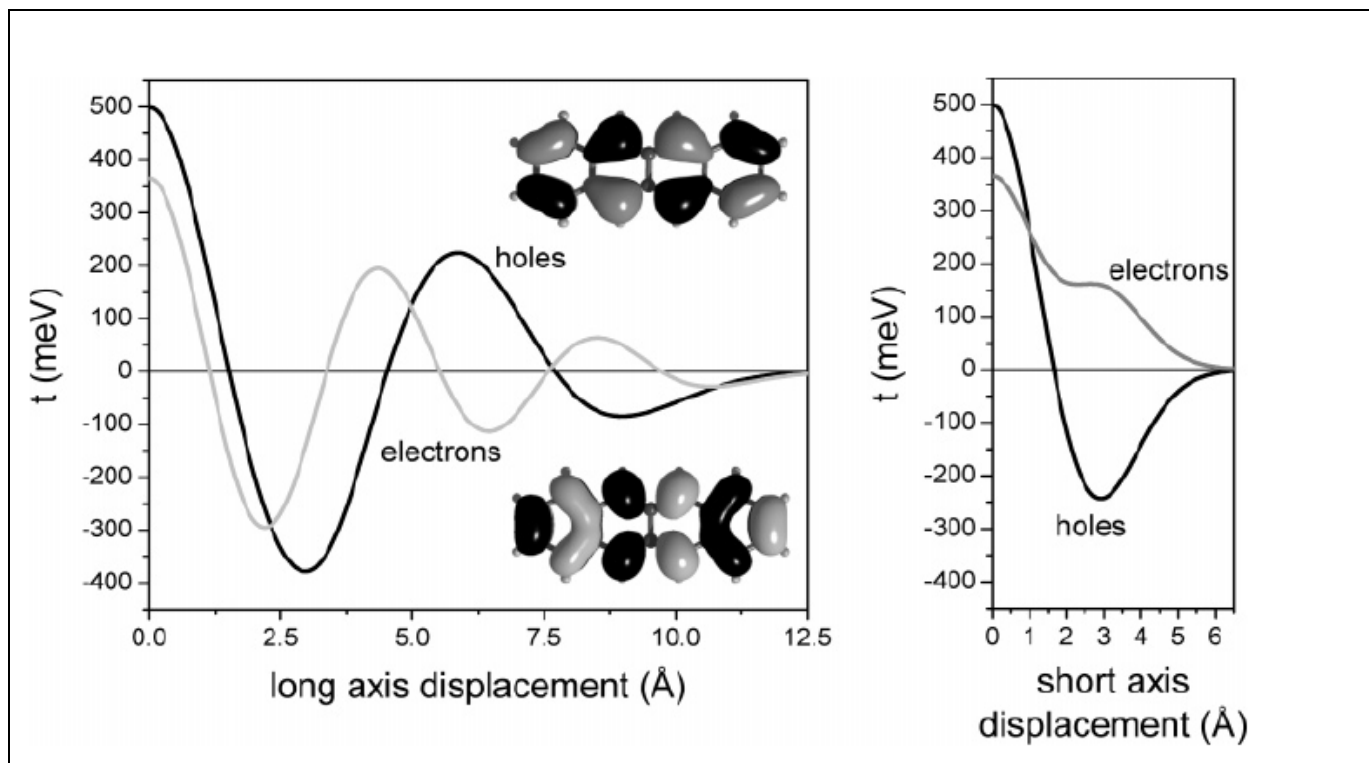

**Figure 4.** Calculated transfer integrals for electrons and holes between to molecules of tetracene displaced along their long and short axes, respectively. The corresponding experimental data has not yet been obtained. From ref. viii

## Summary

This chapter has examined three ways in which atomically precise manufacturing might dramatically improve a technology which consumes more than a fifth of our annual electricity generation. Organic chemistry has the tools now to build large molecular structures with essentially atomic precision and designed functionality, as illustrated by the phosphine oxide examples. We lack the tools to properly arrange such building blocks in the precise order which would maximize the efficiency of light emission and minimize the voltage required to inject charge. If we could do so, it has been calculated<sup>9</sup> that the resulting energy

savings could eliminate the need for 70 nuclear power plants by the year 2025.

Many similar advantages could be gained for conventional LEDs, also. For example, the relatively high conversion efficiency of InGaN LEDs in the presence of an enormous defect density in the crystal structure has recently been ascribed to excited state localization on nanoscale InN aggregates. The designed placing of such particles to maximize plasmon coupling with metal nanospheres could further increase their efficiency. There are further obvious parallels between solid state lighting and solar cells, since

one is basically the reverse process of the other. Many of these potential breakthroughs are described in more detail in reports published<sup>10</sup> by the Office of Science of the

Department of Energy, from which several of the above ideas have been drawn.

---

<sup>1</sup> M.G. Peters, Talk PTuC3, Conference on Lasers and Electro-Optics, May 23<sup>rd</sup> 2006.

<sup>2</sup> M. Pope and C.E. Swenberg "Electronic Processes in Organic Crystals and Polymers" 2<sup>nd</sup> Ed. Oxford Science Publications, 1999

<sup>3</sup> E.A. Silinsh "Organic Molecular Crystals: Their Electronic States." Springer-Verlag, 1980.

<sup>4</sup> P.E. Burrows, A. Padmaperuma, and L.S. Sapochak, P. Djurovich and M.E. Thompson Appl. Phys. Lett. **88**, 183503 (2006)

<sup>5</sup> P. A. Vecchi, A. B. Padmaperuma, H. Qiao, L. S. Sapochak and P. E. Burrows Org. Lett. **8**, 4211 (2006); A.B. Padmaperuma, L.S. Sapochak and P.E. Burrows, Chem. Mater. **18**, 2389 (2006).

<sup>6</sup> P. Anger, P. Bharadwaj and L. Novotny, *Phys. Rev. Lett.* **96**, 113002 (2006)

<sup>7</sup> Holstein 1959

<sup>8</sup> V. Coropceanu et al. Chem. Rev. **107**, 926-952 (2007).

<sup>9</sup> J.Y. Tsao, Laser Focus World, May 2003

<sup>10</sup> Available as a pdf file from <http://www.sc.doe.gov/bes/reports/list.html>

## Towards Gaining Control of Nanoscale Components and Organization of Organic Photovoltaic Cells

This manuscript has been authored by UT-Battelle, LLC under Contract No. DE-AC05-00OR22725 with the U.S. Department of Energy. The United States Government retains and the publisher, by accepting this article for publication, acknowledges that the United States Government retains a non-exclusive, paid-up, irrevocable, world-wide license to publish or reproduce the published form of this manuscript, or allow others to do so, for United States Government purposes.

Control of the properties of individual building blocks and simultaneous organization of such blocks into working device structure is a prerequisite to development of novel applications of nanostructured devices. The same challenges are repeated in general in all applications involving nanomaterials. Here we consider organic photovoltaics as an example of these challenges.

Direct and efficient conversion of sunlight into energy using photovoltaics (PV) is being recognized increasingly as an important component of future global energy production. While silicon-based PV dominate, low-cost PV like nanostructured organic photovoltaics (NOPV) are believed to be a key to the future of inexpensive and efficient PV systems.

Currently, the conversion efficiency of existing NOPVs is close to 5% (for laboratory-scale devices), which is a factor of three smaller than the best efficiency demonstrated by CdTe thin film PV systems or amorphous-silicon PV. CdTe, Si, and Grätzel cells are the most studied and widely used PV candidates today. However, processing them is technologically challenging. The multi-step process involves vacuum deposition, selenization of metal precursors, cathode sputtering or spraying, and electrode deposition, followed by the encapsulation of PV in a polymer layer and the deposition of a protective layer of glass. The size of the PV modules made with this technology is limited by the maximum size of the vacuum chamber. The largest size of CdSe thin-layer PV demonstrated is only 30 cm x 30 cm, and it operated at 12.8% conversion efficiency. The alternative technology of thin layer PV Grätzel cells have a different set of problems. First, the liquid electrolyte lacks stability over time due to evaporation; second, operation occurs in a limited temperature range; and third, there is a major problem with degradation of charge collector electrode material due to the corrosive environment of electrolyte employed. Finally, thin film monocrystalline silicon PV cells have their own set of problems, including: (1) the thickness of Si, which needs to be greater than 10  $\mu\text{m}$  to absorb a significant amount of light, which renders it less flexible; (2) the challenge of growth of large-area monocrystalline silicon; (3) a wire sawing problem; and (4) a conversion efficiency degradation within the first year by 20 to 30% from the original, followed by a steady decline over the next several years. The cost of these technologies remains an obstacle. The low cost of NOPV, the unlimited raw materials supply, the low temperature processing, and the possibility of making large area devices on flexible substrates cheaply make NOPV very

attractive. With a theoretical efficiency similar to that of conventional semiconductor-based PV and with a low-cost structure, NOPVs have the potential of achieving the goal of PV technology: economic generation of large-scale electrical power.

Multiple approaches to NOPV design have been tested thus far, and comprehensive reports can be found elsewhere [Refs. 1, 2]. This report focuses mostly on the benefits of gaining control of zero- and one-dimensional nanomaterials as well as their organization for improved NOPV efficiency.

### Key General Problems of NOPV

1. Low 5 to 6% efficiency. NOPV require at least 10% efficiency for commercialization
2. Small charge mobility, typically measured to be  $10^{-6} \text{ cm}^2/\text{V/s}$  to  $10^{-3} \text{ cm}^2/\text{V/s}$ , which is an order of magnitude smaller than charge mobility in conventional PV cells. Charge mobility is determined by intermolecular overlap of frontier orbitals of adjacent molecules. This overlap is weak compared to inorganic semiconductors. Therefore, a conventional description of band transport for the charge transport in NOPV cannot be used. Instead the carrier hopping mechanism of charge transport is employed.
3. The defective crystalline structure of most NOPV results in poor charge transport efficiency. Change in morphology, loss of interfacial adhesion, and interdiffusion of donor-acceptor components are responsible in part for the general failure mechanism in NOPV.
4. Harvesting “red photons” is challenging. Currently the efficiency of OPC for harvesting “blue photons” is 70%. The target of NOPV will have an active medium with the optical band gap close to 1.4 eV.
5. The interfaces require improvement, especially in multilayer NOPV, since poor interfaces result in high contact resistance between the layers and poor band alignment. Poor wetting between organic and inorganic components of OPV decreases device lifetime.
6. NOPV components show a poor stability to oxygen and water contamination, which results in short lifetime and the need for encapsulation. The morphology of NOPV can be metastable.



## Optimizing the Interface for Mesoscale Three-Dimensional Devices

High efficiency in nanostructured devices does not necessarily require absolute atomic precision of the components, but rather (i) building blocks that are robust against minor fluctuation in the number and positions of their atoms, and (ii) an organization of these building blocks into a working stable structure. The potential components include polymers and various nanomaterials.

The ease of processing long chain polymers by solution casting is one of the major advantages of the OPVs. However, the disorder in intermolecular interactions generally increases as molecules get longer. The absence of intrinsic defects like dislocations, impurities, and non-uniform dopant distribution could improve the photo-generation efficiency of excitons, their dissociation to electrons and holes, and the rapid migration of these charges to the electrodes. The task of designing such a polymer system with a balance between optimal physical properties and fabrication simplicity still exists. Among interesting polymers from this point of view are donor/acceptor block copolymers where self-organization of two different phases could be maintained over large areas [Refs. 3, 4, 5]. Thermodynamically stable co-polymers are expected to have fewer defects.

NOPV can benefit from nanostructured materials in various ways.

1. Zero-dimensional nanomaterials such as quantum dots (QD) in OPV can

- *Improve NOPV spectral response.* Air stable, all inorganic CdSe, CdTe PV has been demonstrated. [Ref. 6]. Nanostructures can improve the spectral response of the polymer and the efficiency of NOPV [Ref. 7].
- QD enable *multiple exciton generation (MEG) conditions* removing the central limitation of existing solar cell approaches, which is the one-to-one relationship between an absorbed photon and a generated electron-hole pair. For instance, as many as three excitons per absorbed photon have been claimed in semiconductor PbSe and PbS quantum dots [Ref. 8]. The efficiency of OPV operating in MEG regime could overcome the Shockley-Queisser limit and possibly approach the thermodynamic limit of PV cells (tandem cell configuration) [Ref. 9]. Since only a small fraction of the photons generate multiple excitons, MEG needs further exploration and research.

NOPV with QD and QD-enabled MEG regime requires an efficient transfer and extraction of the generated excitons into charges, from the nano-structured matter to the contacts. This challenge could be potentially resolved by *one-dimensional nanostructures*, such as nanowires and carbon nanotubes, and positioning QD close to the interface

2. One-dimensional nanomaterials (such as nanowires and carbon nanotubes) in OPV can:

- *Improve electron mobility.* Most of the polymers used in OPV are p-type semiconductors with low electron mobility. Introduction of one dimensional nanostructures such as SWNTs improves electron mobility. [Ref. 10, 11, 12] However, even the high quality of SWNTs used in these experiments were bundles of nanotubes consisting of a mixture of 1/3 metallic and 2/3 semiconducting SWNTs. The bundling of nanotubes produces multiple scattering sites, which decreases electrical conductivity of SWNTs from the ballistic regime by several orders of magnitude. The system is expected to perform better with pure unbundled metallic SWNTs.
- SWNT could *improve spectral response of OPV to NIR photons.* The band gap of semiconducting SWNT depends on the diameter of the nanotube. Nanotubes with diameters between 0.5 and 5 nm could be effectively used to create a system with absorption spectrum matching terrestrial (AM1.5) or extraterrestrial solar spectrum (AM0).
- SWNT could *enable novel transparent conducting electrodes (TCE) with tunable workfunction to replace indium tin oxide (ITO)* and in the design of tandem and multilayer OPVs. With their high conductivity and mechanical flexibility, carbon nanotube networks have the potential to replace relatively expensive and rigid ITO. Unlike ITO, the carbon nanotube TCE workfunction can be changed by non-covalent doping of the nanotube with dopants located on the surface or inside the nanotube. The goal of changing the workfunction without increasing charge carrier concentration is a difficult target. The design of TCE fabricated with nanotubes requires large quantities of homogeneous quality metallic nanotubes and macroscopic processing techniques for processing nanometer thin and micron long nanotubes into macroscopic transparent conductive assemblies [Ref. 13].

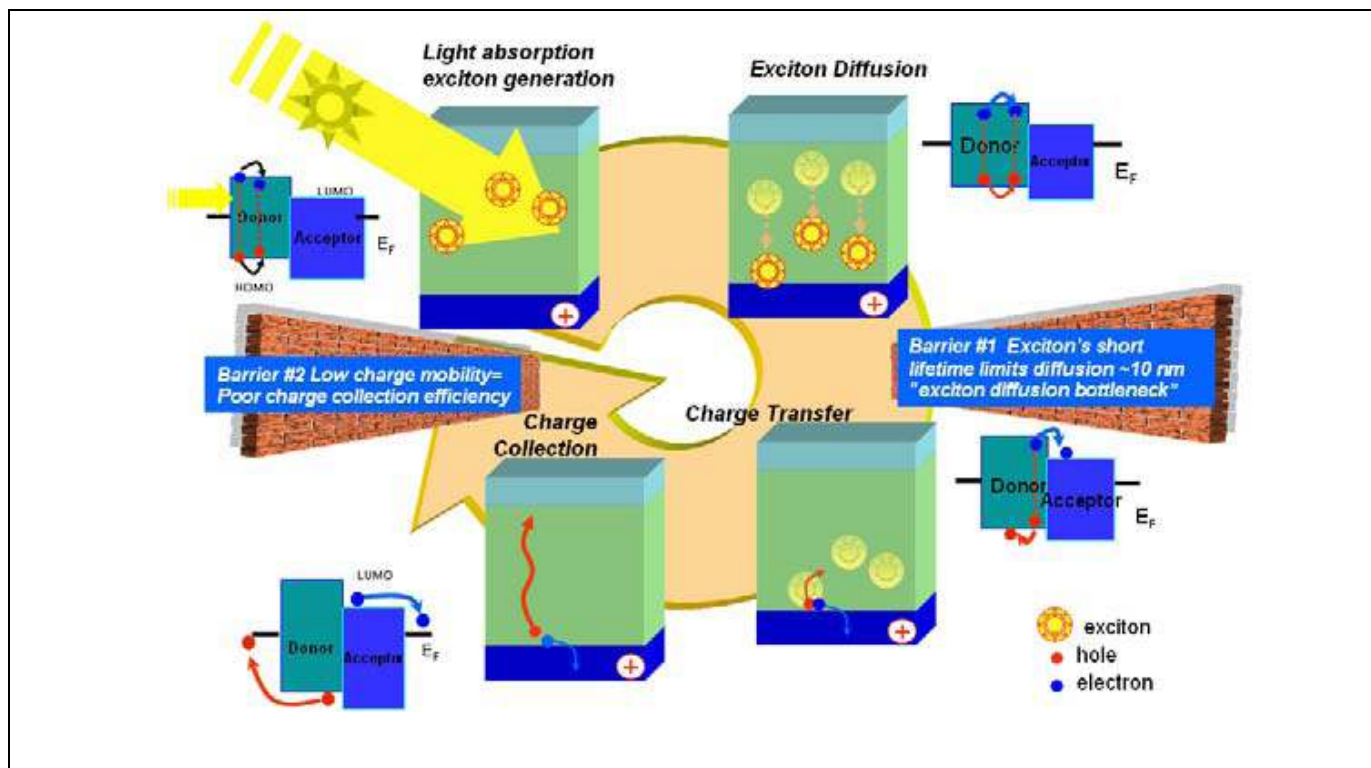

Figure 1. Challenges to overcome in improving the efficiency of photovoltaic devices.

Photovoltaics (including organic photovoltaics) is a relatively new, emerging field which picked up interest with the discovery of conductive polymers (2000 Nobel Prize). To date (August 18th, 2007) the highest reported efficiency was 6.5 %, achieved with a tandem cell by Alan J. Heeger's group [Ref. 14]. The commercialization threshold for OPVs is set at 10% efficiency. Under AM1 solar illumination a 10% efficiency would correspond to  $J = 20 \text{ mA/cm}^2$  current extracted out of the cell. Two major obstacles impede further improvements in OPV efficiency: (1) short lifetime of exciton (exciton diffusion bottleneck) and (2) low charge mobility. These problems require atomically precise engineering of each component and their positioning inside the cell.

- *Three-dimensional NOPV structures with vertically aligned arrays have been demonstrated [Ref. 15].* However, the control of spacing of vertically aligned nanowire arrays, and their band gap cannot be controlled. The spacing of wires in arrays will have to be controlled with precision close to a few nanometers (exciton diffusion length).
- *We can envision All-Nanotubes-PV (ANT-PV) in which only nanotube components are used (i.e., semiconducting nanotubes perform simultaneously as a light absorbing and charge generating media, and metallic nanotubes layers work as transparent charge-collecting electrodes).* The ANT-PV could have a multilayer design for more efficient light absorption and spectral tunability. The development of tools for macroscopic assembly of defect-free layer of ANT-PV with nanoscale precision is a major challenge. Perhaps, these tools will use a Langmuir-Blodgett mechanism of self-assembly which has been successfully demonstrated for carbon nanotubes assembly [Ref. 16, 17].
- The atomically perfect lattice of SWNTs provides an excellent skeleton for polymer ordering over distances and directions defined by the nanotube network *enabling the polymer self-assembly* (building an ordered nanointerface). Thus, nanotube networks inside the PV cell could potentially be used to enhance hole mobility by promoting long range polymer order. Such SWNT ordering induced in polymers has been demonstrated for conjugated polymers [Ref. 18]. The nanotube sidewalls should be *atomically perfect over the scale of several microns*. Such systems present challenges for synthesis, processing, and high throughput of quality control.
- Nonlinear effects in nanostructures potentially could be exploited for advanced photon management including upconversion,

downconversion, and waveguides. This goal requires a precise control of the properties at the nanoscale as well as a precise positioning of building nano-blocks ordered to create photonic structures with prescribed properties. This task would be largely benefited by any advance in nanomanufacturing. The development of tools enabling the fabrication of such optical materials is

one of the major tasks to address to improve energy harvesting NOPV applications.

- Improved performance stability of NOPV compared to all-polymer OPV. Addition of carbon nanotubes to polymer tend to increase Tg and improve polymer thermal stability. Implementation of nanotubes in barrier layer of OPV could also improve stability of OPV.

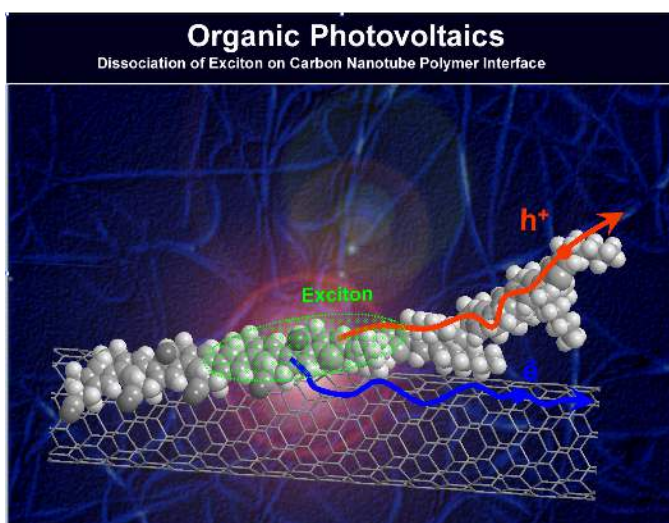

**Figure 2. Dissociation of exciton at nanotube-polymer interface.**

**The polymer diblock structure helps to self-assemble a three dimensional structure of OPV with nanotubes in one phase for improved electron mobility and long range order p-semiconducting polymer in second phase for hole conduction. The background is SEM image of transparent conducting nanotube membrane used as electrode in OPV. The grand challenge of the OPV is enabling atomically precise interface for meso scale OPV for efficient light absorption, exciton generation.**

## General Challenges

In very general terms, an optimized OPV device requires control of the organization of nanocomponents with the right gaps forming interfaces with the right band offsets in a structure that is thermodynamically stable. This general goal involves succeeding in several tasks that include:

- 1) Find components which build a system robust enough to tolerate a certain level of atomic imperfections without hampering high efficiency of the device.
- 2) *Control the synthesis of defect free nanomaterials.* This may require development of a better understanding of multivariable process of nanomaterial synthesis. The challenge calls to improve our understanding and control of defect formation and growth termination. This in turn requires the development and improvement of growth monitoring techniques and tools.
- 3) *New methods for assembly or self assembly of well characterized nanostructured components into meso-scale devices* will be required. A significant advance would be to achieve synthesis of nano materials and assembly of macroscopic structures in a single step.
- 4) Macroscopic applications will require the synthesis of large amounts of materials with homogeneous properties in an economical way for basic, R&D, and production efforts. *New approaches for synthesis of nanomaterial at the commercial scale will have to be developed*, requiring revolutionary engineering design.
- 5) *Quality standards ought to be developed* among various research groups across the world in order to quantify the quality of the material and establish its precise composition and preparation methods in order to be able to reproduce the material elsewhere.
- 6) *New instrumentations should be developed to characterize nanomaterials and for quality control.* Because of the lack of standard quality assessment routines, multiple instruments are required to characterize the quality of a single material and make these process extremely time-consuming.
- 7) *New methods for calculation modeling and simulations* are required across several size scales in order to understand and predict the properties of the individual components and their interactions in a working device. Moreover, since the characterization of nonmaterial is hindered by size reduction and the convoluted structure of their interfaces, experimental data.

These challenges clearly require multidisciplinary teams that combine the expertise of several areas of scientific research



and development. A broad effort must be carried out that involves R&D in fundamental and basic science and extends to practical applications.

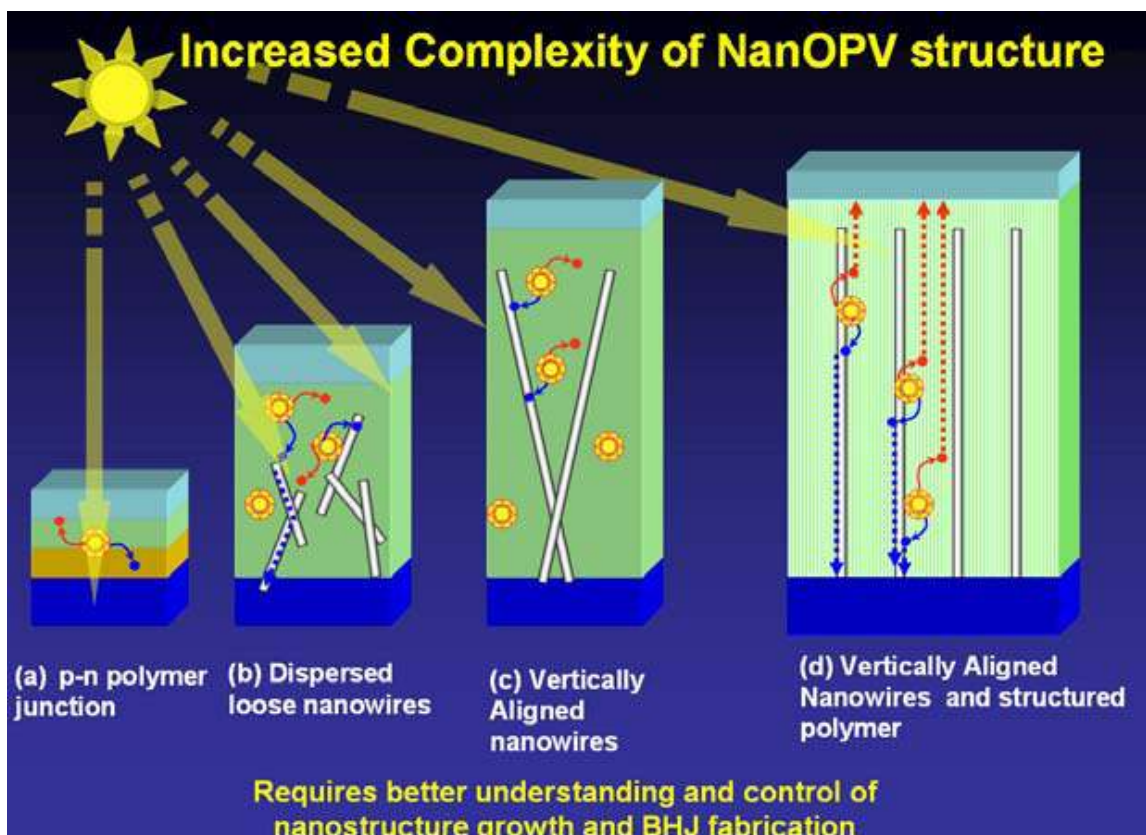

**Figure 3. Increasing complexity of architecture of organic photovoltaic cells requires nanomanufacturing control of nanomaterial quality, positioning.**

**(a) Schottky-barrier between hole conducting polymer and electrode with lower work function.**

**(b) BHJ with dispersed nanomaterials.**

**(c) BHJ with vertically aligned nanomaterials demonstrate improvement over planar devices.**

**(d) BHJ where nanomanufacturing will enable full control of nanomaterial quality, positioning and assembly of next generation NOPV.**

## References

1. DOE BES Report Basic research needs for solar energy utilization April 18-21, 2005  
[http://www.sc.doe.gov/bes/reports/files/SEU\\_rpt.pdf](http://www.sc.doe.gov/bes/reports/files/SEU_rpt.pdf).
2. Innovation and technological development in energy. Photovoltaic: Objectives – Technology.  
[http://ec.europa.eu/energy/res/sectors/photovoltaic\\_en.htm](http://ec.europa.eu/energy/res/sectors/photovoltaic_en.htm)
3. J. A. Gratt, R. E. Cohen (2004). "The role of ordered block copolymer morphology in the performance of organic/inorganic photovoltaic devices." *Journal of Applied Polymer Science* **91**(5): 3362-3368.
4. G. Hadziioannou, (2002). "Semiconducting block copolymers for self-assembled photovoltaic devices." *MRS Bulletin* **27**(6): 456-460.
5. S.-S. Sun (2004). "Design and Development of Conjugated Block Copolymers for Use in Photovoltaic Devices," *Organic Photovoltaics IV*, Aug 7-8 2003, San

Diego, CA, United States, International Society for Optical Engineering, Bellingham, WA 98227-0010, United States.

6. I. Gur, N. A. Fromer, M. L. Geier, and A. P. Alivisatos (2005) Air-Stable All-Inorganic Nanocrystal Solar Cells Processed from Solution, *Science*, 310, 5747, 462.
7. E. Arici, N. S. Sariciftci, D. Meissner (2003). "Hybrid solar cells based on nanoparticles of  $\text{CuInS}_2$  in organic matrices," *Adv. Funct. Mat.*, **13**, 2, 165.
8. R. Schaller, V. Klimov (2004) "High Efficiency Carrier Multiplication in PbSe Nanocrystals: Implications for Solar Energy Conversion," *Phys. Rev. Lett.* **92**, 186601.
9. P. G. Hoertz, A. Staniszewski, A. Marton, G. T. Higgins, C. D. Incavito, A. L. Rheingold, G. J. Meyer (2006). "Toward Exceeding the Shockley-Queisser Limit: Photoinduced Interfacial Charge Transfer Processes that Store Energy in Excess of the Equilibrated Excited State" *J. Am. Chem. Soc.*, 128, 25, 8234 – 8245.
10. E. Kymakis, I. Alexandrou, et al. (2003). "High open-circuit voltage photovoltaic devices from carbon-nanotube-polymer composites." *J. App.Phys.* **93**(3): 1764-1768.
11. E. Kymakis, and G. A. J. Amaratunga (2005). "Carbon nanotubes as electron acceptors in polymeric photovoltaics," *Rev. Adv. Mat. Science* **10**(4): 300-305.
12. Z. Xu, Y. Wu, et al. (2005). "Carbon nanotube effects on electroluminescence and photovoltaic response in conjugated polymers," *Appl. Phys. Lett.* **87**(26): 263118.

13. D. Hecht, L. Hu, G. Gruner (2006). "Conductivity scaling with bundle length and diameter in single walled carbon nanotube networks" *Appl. Phys. Lett.* **89**, 133112
14. E. Kymakis, G. A. J. Amaratunga (2003). "Photovoltaic cells based on dye-sensitisation of singlewall carbon nanotubes in a polymer matrix," *Solar Energy Materials and Solar Cells* **80**(4): 465-472.
15. M. Law, L. E. Greene, J. C. Johnson, R. Saykally, P. Yang (2005). "Nanowire dye-sensitized solar cells," *Nature Materials* **4**, 455 – 459.
16. H. Shimoda, S. J. Oh, H. Z. Geng, R. J. Walker, X. B. Zhang, L. E. McNeil, and O. Zhou (2002). Self-Assembly of Carbon Nanotubes, *Advanced Materials*, **14**, No. 12, June 18, 899.
17. X. Li, L. Zhang, X. Wang, I. Shimoyama, X. Sun, W.-S. Seo, and H. Dai (2007). Langmuir-Blodgett Assembly of Densely Aligned Single-Walled Carbon Nanotubes from Bulk Materials, *J. Am. Chem. Soc.*, **129** (16), 4890-4891.
18. K. P. Ryan, S. M. Lipson, A. Drury, M. Cadec, M. Ruether, S. M. O'Flaherty, V. Barron, B. McCarthy, H. J. Byrne, W. J. Blau, and J. N. Coleman (2004). "Carbon-nanotube nucleated crystallinity in a conjugated polymer based composite," *Chemical Physics Letters*, Volume 391, Issues 4-6, 21 June, Pages 329-333.



## Impact of Atomically Precise Manufacturing on Transparent Electrodes

Transparent electrodes are used in a variety of applications such as flexible displays, touch-panels, light-emitting diodes, photovoltaic cells, and smart windows, to mention just a few. The market for transparent conductive films and coatings exceeds \$1 billion per year and is growing between 15% and 25% annually. While only a few materials currently serve the market, new material advancements are needed to address deficiencies in existing materials performance. A limiting factor in realizing many future applications is a lack of materials with suitable combinations of properties.

The most important characteristics for a transparent electrode are its electronic and optical properties. The electrical and optical performance of a transparent electrode may be ranked by a Figure of Merit, defined as the ratio of the electrical conductivity to the absorption coefficient at the wavelength of interest.<sup>1</sup> Other properties including durability, adhesion to organic layers, stability to environmental and processing conditions, surface roughness, work function, and ability to pattern are also important. Specific applications, naturally, place more emphasis on certain of these properties, while allowing more leeway on other properties. Flexible display applications require electrodes with good mechanical properties such as flexibility, durability, and adhesion to polymeric substrates. Generally high transparency is desirable since these displays typically operate in a reflective mode, but lower conductivity can be tolerated due to the low bit rate of the display. Smart windows require electrodes with high transparency and neutral color density, but tolerate lower conductivity since they are low speed and draw little current. Photovoltaic (PV) applications require high transparency across the solar spectrum, work function matched to the PV cell, and high conductivity. Waveguide applications require extremely high conductivity for traveling wave electrodes or the RF power loss is prohibitive.

At present, multiple materials are used as transparent electrodes, each having advantages for different applications. However, no universal material exists that meets all of the performance requirements. The most common transparent electrodes are based on transparent conducting oxides (TCOs), most commonly indium tin oxide (ITO). Depending on the processing conditions, the conductivity of ITO ranges from  $10^3$  to  $10^4$  S/cm<sup>2</sup> and the absorption coefficient is about 0.04.<sup>1</sup> While the electrical and optical properties of TCOs are sufficient for some applications, their poor durability, flexibility and adhesion to substrates is a limitation. In addition, the Figure of Merit is too low for applications that require very high conductivity, such as waveguides.

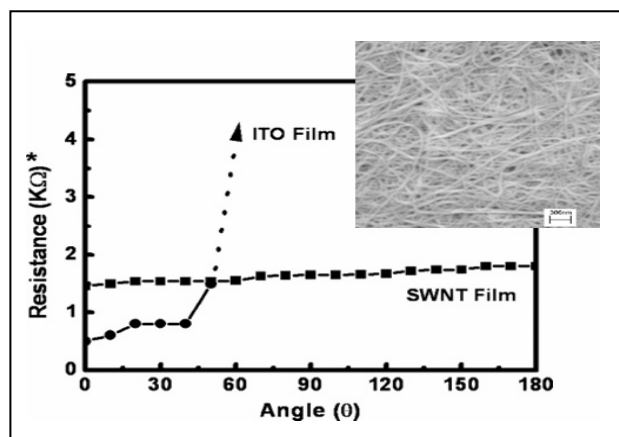

**Figure 1. Comparison of ITO on PET to CNT Network on PET. Plot shows the change in resistance as a function of bend radius. Figure modified from Saran *et al. J. Am. Chem. Soc.* 2004, 126, 4462. Inset shows an SEM image of a CNT network.**

A new transparent electrode based on carbon nanotubes (CNTs) has the potential to surpass the electrical and optical properties of current TCOs, and provide improved mechanical properties, neutral color density, and compatibility with organic materials, using a readily available feedstock and thin film material on the order of nanometers thick. To date, advantages in durability, adhesion, and flexibility have been demonstrated, but only modest electrical and optical performance has been observed when compared to ITO.<sup>3,4</sup> Atomically precise manufacturing has the potential to help produce CNT networks with properties that offer orders of magnitude improvement over current materials. It can do this in three ways: (1) increase conductivity through the production of specific CNT structures, (2) increase transparency and conductivity through precise placement of CNTs to form ideal CNT network morphologies; and (3) increase conductivity by decreasing CNT-CNT junction resistance.

### Production of Specific CNT Structures

CNT networks are random mats of CNTs, i.e. composites of CNTs and air. The sheet conductance increases as a function of CNT network density and has been found to follow 2D percolation behavior, approaching a plateau value at high density.<sup>5</sup> The main contributions to the conductivity near the plateau value are the resistance of the CNTs and the resistance at the junctions.

The room temperature resistivity of an individual metallic CNT has been reported to be in the range of  $10^{-4}$  to  $10^{-6}$   $\Omega\cdot\text{cm}$ , while that of a semi-conducting CNT is about  $10^1$   $\Omega\cdot\text{cm}$ .<sup>6</sup> Since no methods currently exist to produce CNTs of precise structure, CNT networks to date have been prepared from CNTs with mixed diameter and chirality. Generally, they have been prepared from solution dispersion methods, which yield networks composed of bundled CNTs. Considering that the CNTs are about 33% metallic and 10-20 tubes are found in a bundle, the probability that a bundle contains at least one metallic tube is almost 1, but the percentage of metallic tubes in the bundle can vary dramatically. This situation leads to a composition where the bundles have different character, some being more conducting than others depending on the number of metallic tubes present and the arrangement of the CNT within the bundle. For example, the resistance of a bundle of two metallic SWNTs was estimated to be, at most, 3 k $\Omega$ , after taking into account the contribution from contact resistance; whereas, a 3 nm diameter bundle containing only semi-conducting SWNT showed a resistance 60 M $\Omega$ .<sup>7</sup>

APM could allow for synthesis of highly perfect, metallic tubes. This would increase the conductivity per absorption by at least a factor of three, and more if close to the percolation threshold. High degrees of perfection would lead to enhanced delocalization and lower resistance along the tube.

## Precise Placement of CNTs

The absorption coefficient of a single nanotube is quite high, approximately 0.15 for light polarized along the CNT, much higher than that of TCOs. However, the absorption of CNT networks is a composite of contributions from the randomly oriented CNTs and air. Lower density, thin networks obviously have lower absorption coefficient. The challenge is how to achieve high conductivity while maintaining low absorption. The simple 2D percolation model predicts that increasing the aspect ratio (i.e. length/diameter) is one way of forming a conducting network at low loading. Current dispersion methods tend to shorten tube/bundle length. APM would allow for the precise placement of CNTs with long lengths. In addition, the fact that the current networks are composed of 10-20 nm bundles means that the minimum film thickness is 10-20 nm, instead of the ideal single tube 1 nm.

More significantly, APM would allow the precise placement of CNTs and the formation of non-random structures. The ideal structure that still exhibits isotropic conductivity in two-dimensions is a grid. One can envision a layer of single nanotubes, positioned in a grid, where the spacing between nanotubes could be varied from 100 nm to 1000 nm, depending on defect scattering lengths. The density of such a network could thus be decreased to less

than 1%, leading to an effective absorption coefficient of  $<<0.01$ , and the film thickness decreased to 1 nm.

Few of the envisioned applications require isotropic conductivity. Experiment and modeling indicate that films formed from oriented CNT give higher conductivity in the direction of orientation. Oriented CNT films will also have polarization dependent loss. The waveguide applications will strongly benefit from oriented films, as the loss for light polarized orthogonal to the direction of orientation will have lower loss.

## Reduction of CNT-CNT Junction Resistance

Conduction in CNT networks occurs through a combination of metallic electron propagation down the length of a nanotube (or bundle) and electron hopping between bundles. Because the temperature dependence of the metallic conductance and electron hopping are different, temperature-dependent resistance measurements can be used to separate the relative contribution of these two terms. From this fitting data, we find that even above room temperature, more than 70% of the total resistance of the nanotube film is due to the junction resistance between bundles of CNTs, depending slightly on the composition of the nanotube film (tube diameter, length). Fuhrer et al found that the junction resistance between crossed metallic-metallic junctions is about 100 to 300 k $\Omega$  while that between crossed metallic-semiconducting junctions is 1,000 to 10,000 k $\Omega$ .<sup>8</sup> Therefore, the impact of APM to produce pure metallic nanotubes will also reduce the junction resistance. Nonetheless, the resistance of crossed metallic-metallic junctions is still significant.

A real benefit of APM will be the potential to produce junctions with controlled geometry and alignment of atomic lattices. The potential to lower the junction resistance by changing the structure of the contacts is shown in Figure 2.<sup>9</sup> Modeling suggests that the junction resistance between CNT is dependent on the relative orientation of the tubes. Parallel junctions have higher junction cross sections and also have larger overlap between the quasi-1D electron orbitals. While previous studies on the interaction between coplanar benzenes have shown little sensitivity to the rotation of the phenyls, recent calculations using more extended aromatics (naphthalene, anthracene) have shown the interaction across the junction between the rings can vary by more than an order of magnitude.<sup>10</sup>

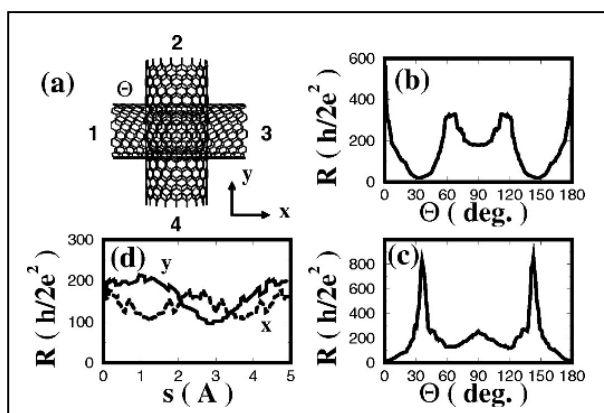

**Figure 2. (a) A model of four-terminal junction formed by crossing two nanotubes. (b) Contact resistance of the (18,0)-(10,10) junction as a function of rotation angle  $\Theta$ . The tubes are in-registry at  $\Theta = 30, 90, 150^\circ$  (c) Resistance of the (10,10)-(10,10) junction. The tubes are in-registry at  $\Theta = 50, 60, 120, 180^\circ$ . (d) Resistance of the (18,0)-(10,10) junction as functions of translation of one tube relative to the other in the  $x$  and  $y$  directions. Figure from Buldum and Lu *Phys. Rev. B* **2001**, *63*, 161403.**

In addition to parallel and crossed junction, fused junctions such as “Y”, “T”, and “X” junctions may be prepared interconnecting multiple nanotube segments. Nanotubes with different atomic structures have been fused connected experimentally by introducing pentagon and a heptagon defects into the hexagonal carbon lattice using methods such as electron beam welding.<sup>11</sup>

The junction resistance is also strongly dependent on the spacing between the tubes or bundles, with an approximate exponential increase in the junction resistance with separation between the nanotubes. Decrease of the spacing between bundles from the  $\sim 3.4\text{\AA}$  van der Waals separation to approximately  $2.84\text{\AA}$  would decrease the junction resistance by a factor of approximately three. APM would allow creation of junction with the desired orientation and spacing.

## Summary

CNT networks offer many advantages over traditional TCOs for transparent electrode applications. They have been shown to exhibit superior flexibility, durability, and adhesion to organic substrates compared to TCOs. They offer the potential to be a universal transparent electrode, suitable for a variety of applications, if certain challenges can be overcome. APM will be critical in solving some of these challenges. Through the synthesis of defect-free, metallic tubes, the precise placement of nanotubes to form

low density and/or oriented geometries, and the modification of junctions, APM could produce CNT electrodes that have electrical and optical properties that are orders of magnitude better than current materials.

## References

- Gordon, R. G. *MRS Bulletin* **2000**, 52-57.
- Paine, D. C.; Yeom, H. Y.; Yaglioglu, B., Transparent conducting oxide materials and technology. In *Flexible Flat Panel Displays*, Crawford, G. P., Ed. John Wiley and Sons: 2005.
- Saran, N.; Parikh, K.; Suh, D. S.; Munoz, E.; Kolla, H.; Manohar, S. K. *J. Am. Chem. Soc.* **2004**, *126*, (14), 4462-4463.
- Wu, Z.; Chen, Z.; Du, X.; Logan, J. M.; Sippel, J.; Nikolou, M.; Kamaras, K.; Reynolds, J. R.; Tanner, D. B.; Hebard, A. F.; Rinzler, A. G. *Science* **2004**, *305*, (5688), 1273-1276.
- Hu, L.; Hecht, D. S.; Gruner, G. *Nano Lett.* **2004**, *4*, (12), 2513-2517.
- Saito, R.; Dresselhaus, G.; Dresselhaus, M. S., *Physical Properties of Carbon Nanotubes*. Imperial College Press: 2004.
- Bachtold, A.; Fuhrer, M. S.; Plyasunov, S.; Forero, M.; Anderson, E. H.; Zettl, A.; McEuen, P. L. *Physical Review Letters* **2000**, *84*, (26), 6082.
- Fuhrer, M. S.; Nyg; aring; rd, J.; Shih, L.; Forero, M.; Yoon, Y.-G.; Mazzoni, M. S.; nbsp; C; Choi, H. J.; Ihm, J.; Louie, S. G.; Zettl, A.; McEuen, P. L. *Science* **2000**, *288*, (5465), 494-497.
- Buldum, A.; Lu, J. P. *Physical Review B* **2001**, *63*, (16), 161403.
- Lee, M.; Shephard, M. J.; Risser, S. M.; Priyadarshy, S.; Paddon-Row, M. N.; Beratan, D. N. *J. Phys. Chem. A* **2000**, *104*, (32), 7593-7599.
- Terrones, M.; Banhart, F.; Grobert, N.; Charlier, J. C.; Terrones, H.; Ajayan, P. M. *Physical Review Letters* **2002**, *89*, (7), 075505.



# Atomically Precise Fabrication for Photonics: Waveguides, Microcavities

## Introduction

Photonics devices are broadly defined as those devices which generate, transport, process, or detect photons. Photonics technology has many advantages over electronic technologies for communications, signal processing, computation, and sensing which include higher data transmission rates, higher data processing speeds, and immunity to electromagnetic interference. In order to meet the consumer demand for products with higher bandwidth, photonics technology has begun to converge with electronics technology on silicon chip platforms in many commercial applications, such as computers, mobile phones, and video games. While photonics components have many performance advantages over electronic circuits, the integration of multiple photonic components on a single chip platform has been exceedingly challenging with current microfabrication technology and the levels of integration achieved to date in photonics devices is many orders of magnitude less than those routinely demonstrated by the semiconductor industry. As will be described in the following section, atomically precise fabrication is expected to enable generation of high performance waveguides and microcavity elements which are critical toolbox elements for the generation of highly integrated photonics devices. By improving performance and increasing the levels of integration of photonics components, this technology will enable a next generation of high performance, highly integrated compact technologies to support a wide variety of communications, information processing, imaging, and sensing applications.

## Increased Performance and Higher Levels of Integration of Photonics Components through Atomically Precise Fabrication

In order to achieve higher levels of integration, as required for the creation of the next generation of compact, low power photonics devices, the fabrication challenges are threefold:

- Increase performance and manufacturability of individual active and passive photonic components

- Integrate active and passive components on the same chip, for example lasers modulators, switches, detectors with waveguides, filters, multiplexers.
- Integrate active and passive photonics components with electronic components

While there has been a lot of research devoted to achieving high performance active and passive technologies on a single platform to achieve monolithic integration, no platform has demonstrated state of the art performance for all critical active and passive components (e.g., while silicon passive components have routinely outperformed passive InP components, active components in silicon are currently outperformed by InP). Consequently, hybrid integration approaches with large packaging costs are many times pursued over monolithic integration approaches in order to achieve better performance. It is envisioned that atomically precise fabrication will lead to the generation of higher performance active and passive components on a common platform through the capability of this technology to construct ultra low loss photonics subcomponents, such as waveguides and resonant microcavities. Further, atomically precise fabrication will enable novel nanoscale technologies (quantum dots, quantum wells, nanotubes) to be integrated onto a common chip platform to increase functionality and facilitate the achievement of high levels of monolithic integration.

Essential to the generation of high performance photonics components is the capability to fabricate optical circuits which have low optical loss, efficiently couple/switch photons between channels in a controlled manner, and propagate photons in a well defined polarization state. The parameters which are commonly used to benchmark the performance of photonics circuits are insertion loss, coupling loss, channel crosstalk, channel bandwidth, polarization dependent loss (PDL), and birefringence. These benchmark parameters are highly correlated with material purity and microfabrication process conditions as described in Table 1. Table 1 can be viewed as a compilation of photonics errors which are introduced due to the non precise nature of current microfabrication processes to create photonics devices.



**Table 1. Influence of Imperfect Fabrication Processes on Photonics Circuit Elements**

Process Issue	Description	Negative Impact on Performance	Current Solutions
Material Defects and Impurities in Waveguide Channels	Defects or impurities in materials comprising the waveguide channels can scatter photons out of a channel or change the polarization state of the photon	Increased insertion loss, increased levels of channel crosstalk, altered polarization state of photon	High purity crystal materials have demonstrated low levels of loss, but achieving high levels of integration is problematic
Sidewall Roughness in Fabricated Waveguides	Roughness along waveguide sidewalls is inherent in the etch processes required to define the waveguide structures. Magnitude of the surface roughness is strongly correlated with photon loss and crosstalk error.	Increased insertion loss, increased levels of channel crosstalk, altered polarization state of photon	Thermal and laser reflow processes have been developed to obtain sidewalls with near atomic smoothness. Reflow processes significantly alter dimensions of waveguide structures, decrease critical dimension control, and complicate integration
Critical Dimension Control	Performance of photonic circuits is a strong function of geometry of circuit elements, including coupling gaps between elements	Variations in coupling between channels, polarization dependent effects (birefringence, PDL)	Variations in coupling gaps are compensated with post fabrication tuning or integration of MEMS technology for active control
Film Stress	With heterogeneous integration of material layers, residual stress levels can lead to polarization dependent effects on propagating photons and lead to cracks and defects in material layers	Polarization dependent effects (birefringence, PDL) due to stress. increased loss and channel cross talk due to cracks, defects	Hybrid integration techniques are often pursued, particularly for integration of sources and active elements with increased packaging costs
Thermal Management	Heat generated in active components can impact the performance of active and passive elements	Variations in device performance, wavelength shift in targeted center frequency for specific optical channels	Additional process steps are added to isolate optical channels and dissipate heat. Athermal optical circuit designs are pursued where possible.

It is anticipated that atomically precise fabrication of photonic components will enable the fabrication of photonics components with lower optical loss, lower levels of cross talk between channels, and a higher degree of polarization control than photonics devices fabricated with current state of the art technology due to the capability of this technology to achieve the following:

- **Defect Free Lattices:** alleviate scattering losses, cross talk, and polarization effects associated induced by material defects
- **Atomically Smooth Sidewalls:** surfaces will substantially reduce scattering losses at the sidewall interfaces without the need for thermal or laser reflow processes which substantially alter critical dimensions
- **Precise Critical Dimension Control:** Precise internal structure and atomically precise positioning capability will enable highly accurate critical dimension control which is required to optimize circuit performance. Precise critical dimension control will facilitate the transition from prototype to manufacturing and increase manufacturing yields.
- **Creation of Novel Nanoscale Technologies:** the capability to generate precise internal structures will facilitate the generation of novel materials which will be required to manage the thermal energy (e.g. converting it to useful electrical energy) and precisely engineer film stress levels to enable propagation of radiation in a well defined polarization state.

While atomically precise fabrication is anticipated to lead to increased performance in many photonics circuit toolbox elements, waveguides and microcavities have been identified as two key technologies central to the generation of compact photonics components across a wide variety of fields. For that reason, the focus of this section will be these technologies and the benefits enabled by atomically precise fabrication.

### Ultra Low Loss Waveguides

To date, low delta, micron scale silica waveguides have been designed to transport photons with low loss levels and have found widespread application in the telecommunications field. With these low delta waveguide designs, achieving high levels of integration is challenging because curved segments must have a minimum bend radius

on the millimeter scale to efficiently couple photons around bends. As a consequence, optical circuits comprised with this technology take up a lot of real estate and limit the density of circuit elements which can be placed on a chip. High delta waveguides such as nanoscale, air clad silica or silicon waveguides, which are commonly referred to as wires, have demonstrated the capability to efficiently transport photons around sharp bends with micron scale dimensions. However, these nanoscale waveguides typically have orders of magnitude higher levels of photon loss along straight channels due to strong interactions between the photons and the sidewalls, where rough sidewall features lead to scattering. Due to the capability of atomically precise manufacturing to achieve defect free structures with atomically smooth sidewalls, the performance of waveguides constructed with this technology should have much lower losses than commercially available waveguides. Further, the precise positioning capability of this technology will enable fabrication of nanoscale waveguides which can propagate radiation in a well defined polarization state and can efficiently couple photons around sharp bends and achieve high levels of integration without compromising performance. The reduction of photon losses in optical waveguides will lead to improved performance in components across many fields. In telecommunications, lower optical losses will increase the distance over which optical data can be transported before amplification is required. For information processing, lower photon losses in waveguides will result in a lower number of processing errors.

## Ultra High Q Microcavities

It is envisioned that precision atomic fabrication will enable a quantum step forward for the generation of chip scale, ultra high Q compact microcavities which can be manufactured and integrated into sensor arrays and optical circuits. The Q value of an optical microcavity is a benchmark parameter which is directly related to the length of time in which the photon circulates or is stored in the optical microcavity. Consequently, any defects either internally (e.g. material defects) or externally along the photonics surfaces comprising the microcavity (e.g. sidewall roughness) which induce scatter will increase photon loss and result in a reduction in the Q of the microcavity. There has been a strong push in the photonics field over the last decade to develop manufacturable processes to enable integration of high Q microcavities on a chip to support development of novel high performance passive components (e.g. sensors, filters, multiplexers) and active components (e.g. lasers, amplifiers, switches).

High Q microcavities are anticipated to be an enabling technology for the development of many novel approaches to achieve compact, chip scale technologies which integrate active and passive component on the same chip. A short list of applications for high Q chip scale microcavities at a component level is presented in Table 2. While waveguide based sensors have demonstrated the capability to sense chemicals, biological agents, strain, rotation, and acceleration, novel approaches which utilize high Q microcavities are currently being pursued due to the capability of these structures to achieve large effective waveguide path lengths in small volumes. For example, for micron scale cavities with Q values  $\sim 10^{10}$ , the photon travels an effective path length of kilometers in a micron scale areas on a chip. Equivalently, kilometer long waveguide/fiber designs to achieve amplification and lasing can be compressed into micron scale dimensions with this technology. Additionally, these microcavities can be configured as switches and multiplexers to route and store data, whereby through active tuning of the resonant conditions of the cavities by optical, thermal, mechanical, or electrical control data can be stored and routed in a controlled manner to support information processing and communications applications.

To date, several technologies have been pursued to fabricate high Q microcavities on silica and silicon chips to support these applications and include:

- **Ring Resonators** – closed loop waveguides fabricated on silica or silicon chips, Achievable Q values ( $\sim 10^6$  limited by sidewall scatter and material defects).
- **Toroidal Ring Resonators** – promising technology developed by Caltech where closed loop toroidal rings with diameters on the microns scale are formed through a laser reflow process. High Q levels have been demonstrated ( $\sim 10^9$ ) due to atomic smoothness of surface after laser reflow. Manufacturability will be challenging due to large change in dimensions upon laser reflow.
- **High Q Crystal Resonators** – very high Q values ( $\sim 10^{12}$ ) demonstrated in  $\text{CaF}_2$  and Lithium Niobate due to low number of crystal defects. Smooth surfaces are achieved by hand polishing and sizes are limited to millimeter scale. Integration of several microcavities into a circuit or array is problematic.
- **Photonics Bandgap Structures** – critical dimension control is difficult and has prevented achievement of high Q values which are theoretically predicted. The capability for precise fabrication is anticipated to substantially increase Q values.

**Table 2. Applications for High Q Microcavities – Passive and Active Components**

Application	Microcavity Function	Merit of High Q
Sensors: Chem/bio, Acoustic, Navigation (Passive)	Photons sense environment while circulating in microcavity. By monitoring phase and amplitude of optical power presence of chem/bio molecules (spectrometers) can be detected, strain levels measured (ultrasonic imaging, acoustic detection), and rotation/ acceleration monitored (navigation)	Higher Q: lower threshold detection limits (chem/bio detection), diagnosis of diseases at early times/stages (medical), higher imaging quality (ultrasonic), and higher rotation/ acceleration sensitivity (navigation)
Filters, Transceivers, Multiplexers (Passive)	Photons are coupled into resonant cavity when resonant conditions are met (a function of photon wavelength, $\lambda$ ) enabling filtering or discrimination of photons based on $\lambda$	Higher Q: narrower bandwidths (filters), larger number of communications channels (transceivers, multiplexers)
Lasers, Optical Sources (Active)	Amplification of photons in resonant cavities leads to lasing when doped with rare earth materials or achieved through Raman processes	High Q in small volume: lasers with low threshold lasing levels
Switches, Modulators (Active)	Photons are coupled into microcavities when resonant conditions are satisfied. Resonant conditions are dynamically controlled through thermal optical, electrical, or mechanical control to achieve switching and modulation	Higher Q: lower switching/ modulation power, higher switching/modulation speeds,
Data Buffers, Optical Delays (Active)	Tunable optical delays, optical buffers. Photons are stored in microcavities and retrieved from microcavities in synch with processing clock by tuning and detuning resonant conditions	Higher Q: longer photon storage times for computation

The two technologies listed above which have generated the highest Q values to date, toroidal ring resonators and high Q crystal resonators, have significant chip level integration challenges, where creating sensor arrays and highly integrated circuits with these technologies will be exceedingly challenging. It is envisioned that atomically precise fabrication will be an enabling technology for the next generation of compact, ultra high Q microcavities due to the capability of this technology to achieve the atomically smooth surfaces and defect free material layers which are required to generate high Q values, while having the manufacturing advantage of precise patterning and tight critical dimension control which will be required for integration of multiple microcavities into high density circuit elements or sensor arrays.

## High Q Cavity Applications

### *Compact, Low Threshold Lasers*

The Kerry Vahala research group at Caltech has demonstrated low threshold lasing in the toroidal resonator microcavities, which have diameters of roughly 30 microns. They have demonstrated chip scale, microcavity configurations which operate as Raman lasers along with microcavities configurations which demonstrate lasing with introduction of the rare earth elements, erbium and

ytterbium. It is anticipated that a next generation, low threshold power laser could also be developed with this technology could be developed by integrating quantum wells or quantum dots on the same chip as high Q microcavities. The threshold levels required to achieve lasing is a function of the ratio of cavity Q to mode volume, V. Ultra low threshold levels for lasing could be demonstrated by increasing Q or reducing the size of the microcavity. With atomically precise fabrication, ultra high Q cavities with small mode volumes could be fabricated and designed to efficiently couple to quantum dot structures. With the development of low threshold lasing technology, energy harvested on the chip through thermal or solar energy could be used to power these lasers.

### *Chip Scale, Chem/Bio/Medical Sensors*

The Kerry Vahala research group at Caltech has also demonstrated the capability to detect single molecules through label free means by using the toroidal resonator microcavities with functionalized surfaces to selectively bind target molecules. While this technology can be configured to detect a single target molecule, sensor arrays will have to be fabricated to detect a larger number of target molecules, which will require chips with multiple microcavities on a single chip. The development of this sensing technology has applications in a number of fields:

- Medical – early detection of disease
- Defense/Homeland Security – detection of chem/bio/explosives
- Environmental, Health – monitoring air and water pollution, food contamination

The vision for the next generation of sensor technologies is to develop compact sensors which have the following functionalities:

- Integrated sources and sensors array on a chip
- Compact configurations which can be discreetly placed in environment (defense, environmental applications) or worn by a human (medical)
- Biocompatible platforms to enable in vivo monitoring to support medical applications
- Low energy requirements, utilization of energy harvested power
- Capability to process sensor data on the same chip as the sensor or couple this data onto an antenna for transmission to a remote post for processing
- Signal an alert when a molecule, be it a hazardous chemical, biological compound, or precursor to a disease, is detected to a remote listening post

High Q cavities are anticipated to be an enabling element for this technology as they can be utilized to create compact chip scale optical sources (e.g. lasers) and sensor arrays along with the filters, routers, and switches required to process and communicate the data. It is anticipated that atomically precise fabrication could be leveraged to construct the high Q cavities, integrate novel materials for energy harvesting, and generate precise structures which will bind target molecules with a high degree of selectivity.

### *Quantum Information Science*

The emerging field of quantum information sciences has been pursued due to the capabilities of this technology to lead to quantum leaps forward in the fields of computation, secure communication, and encryption. Quantum networks

and node configurations are currently being pursued by a wide variety of researchers which function through the strong coherent interactions of light and matter, whereby trapped atoms or quantum dots are coupled to high Q microcavities. The Vahala and Kimble research groups at Caltech have demonstrated strong interactions between trapped atoms and single photons circulating in high Q, toroidal resonant cavities in support of this technology.

It is anticipated that high Q microcavities will be utilized for multiple components in support of quantum information processing including construction of logic gates, optical buffers/delay gates, single photon sources, and converters of atomic qubit logic to optical logic (for those approaches which utilize atomic logic elements for processing). Ultra high Q cavities and ultra low loss waveguides are essential for optical approaches to quantum computation as information is stored and processed as individual photons and any photons lost in the circuit will either increase the incidence of errors or increase the scale of circuit required to achieve low rates of errors.

### *Optical Information Processing*

There has been a strong push in the field of optical information processing to increase processing speed using all optical processing technology. Currently, for information processing, photons do not manipulate photons without first interacting with electrons. Consequently, hybrid technologies are required to manipulate both photons and electrons for information processing applications. Researchers are actively pursuing technologies to enhance non-linear interactions in order that photons can manipulate photons without interacting with electrons. This would alleviate the need for hybrid technologies and increase information processing speed (photon interactions are faster, though weaker). Compact microcavities with high Q values and small mode volumes enhance non-linear interactions and reduce switching times. Researchers are actively pursuing integration of Kerr materials and other novel materials into microtoroid resonators to enhance non-linear interactions and enable all optical information processing. Atomically precise fabrication would enable the generation of the high Q cavities in small mode volumes and enable precise positioning of novel materials to enhance non-linear interactions.





## Impact of Atomically Precise Manufacturing on Waveguide Applications

Advances in waveguide technology have created the information revolution of the past 20 years. Future advances in waveguide technology due to atomically precise manufacturing (APM) could have impacts as large, or larger, in information technology and sensor fabrication, in addition to enabling the development of silicon photonics.

The continued expansion of the data-carrying capacity of fiber-optics networks requires the continued development of optical devices with increased functionality. Of particular interest is the development of amplifiers directly integrated into key passive components, such as star couplers and wavelength demultiplexers, and the development of components utilizing photonic band gaps or other specific arrangements of multiple materials. In the case of amplifiers, APM will allow higher dopant levels without quenching, leading to optical amplification in shorter path lengths and allowing more compact (and less expensive) device fabrication. APM will enhance the development of photonic band gap (or similar) devices by allowing more precise control of the refractive index patterns that enable the device function. Additionally, the application of APM methods to electrode fabrication may allow the realization of devices that are impossible using conventional lithographic methods.

Waveguide sensors have multiple attractive features, including compactness, robustness, resistance to electromagnetic interference, and remote connection to instrumentation using optical fibers. These sensors primarily operate using either evanescent field sensing techniques (grating couplers, waveguide interferometers, surface plasmon resonance sensors) or surface acoustic wave techniques. In both cases, the waveguide surface is treated to allow binding of the desired species, which alters the signal propagating along the waveguide. APM can enhance these sensors in multiple ways, including the fabrication of patterned surfaces on the waveguide to allow detection of multiple targets, formation of tailored binding sites to reduce the non-specific binding of other species to the surface, and the fabrication of waveguides with tailored optical or acoustical properties that would allow for improved or alternate signal transduction.

Silicon photonics is an effort to increase the bandwidth of the connections between microprocessors by using optical transfer of data. The key is all components of the optical interconnects must be fabricated as part of the CMOS manufacturing, using standard techniques. Although silicon waveguides have been used for some time, only recently has continuous lasing been demonstrated in silicon. Because of the much smaller size of optical components in silicon as opposed to silica, APM techniques will be required to allow for the fabrication of the full range of silicon optical components (waveguides, lasers, amplifiers, filters, resonators, attenuators, modulators, ...) needed for the complete realization of the potential of this technology. In particular, fabrication of the laser cavity, and the localized doping of the silicon to form modulators and the lasers will require the integration of APM techniques into the CMOS manufacturing process.

